

Study Material of

ENGINEERING MECHANICS

For

1st and 2nd Semester, DIPLOMA ENGINEERING

(As per SCTE&VT Curriculum)

Prepared by

Mr. Prasant Kumar Patra, Lecturer, Mechanical Engineering (pkpatrafme@kp.kiit.ac.in)

Mr. Abhijit Samant, Lecturer, Mechanical Engineering (abhijit.samantfme@kp.kiit.ac.in)

Mr. Abhijit Prasad Dash, Lecturer, Civil Engineering (abhijitfce@kp.kiit.ac.in)



KIIT Polytechnic, Bhubaneswar

2021-22

CONTENTS

Chapter No.	Title	Page No.
Chapter-1	Fundamentals of Engineering Mechanics (Force, Moment & Equilibrium)	03 – 22
Chapter-2	Friction	23 – 31
Chapter-3	Centroid & moment of Inertia	32 – 46
Chapter-4	Simple Machines	47 – 53
Chapter-5	Dynamics	54 - 68

Fundamentals of Engineering Mechanics

(Chapter 1)

Mechanics	# It is the branch of physical science which deals with the behavior of a body at rest or motion under the action of external forces. Mechanics is divided into <i>statics</i> and <i>dynamics</i> .
Statics	# It is the branch of engineering mechanics which deals with the study of bodies at rest under the action of external forces.
Dynamics	# It is the branch of engineering mechanics which deals with the study of bodies in motion under the action of external forces.
Kinematics	# It is the branch of dynamics which deals with the motion of the bodies without considering the forces causing the motion.
Kinetics	# It is the branch of dynamics which deals with the motion of the bodies considering the forces causing the motion.
Unit	# It is the accepted standard which is used for comparison of a physical quantity. There are four systems of units i.e. C.G.S, M.K.S, S.I and F.P.S.
Fundamental unit	# The units by which fundamental quantities are measured are called as <i>fundamental units</i> .
Derived unit	# The units by which derived physical quantities are measured are called as <i>derived units</i> .
Dimension	# It is a formula by which a physical quantity is expressed in terms of fundamental quantities with suitable power.
Scalar	# A quantity which is specified by its magnitude is called as <i>Scalar quantity</i> . Example: mass, length, area, volume, time etc.
Vector	# A quantity which is specified by its magnitude and direction is called as <i>Vector quantity</i> . Example: force, weight, velocity, displacement, acceleration, moment.
Mass	# It is the total quantity of matter contained in a body. The S.I unit of mass is kilogram (kg). It is constant at all places. It can't be zero.
Weight	# It is the force with which a body is attracted towards the centre of earth. The S.I unit of weight is Newton (N). It is different at different places. It is zero at the centre of earth.
Length	# It is the linear distance between two points. The S.I unit of length is metre (m).
Time	# It refers to the sequence of events. The S.I unit of time is second (s).
Particle	# A <i>particle</i> is an object having mass but no size. It has negligible dimension.
Body	# A <i>body</i> consists of matters but having definite mass and volume.
Rigid body	# A body which doesn't deform under the action of forces is known as a <i>rigid body</i> .
Deformable body	# A body which deforms under the action of forces is known as a <i>deformable body</i> .
Elastic body	# A body which can deform under the action of external forces and come back to its original shape and size after the removal of forces is known as <i>elastic body</i> .

Fundamental Quantities:

Fundamental quantities are the quantities, which cannot be expressed in terms of any other physical quantity.

Example: length, mass and time. There are seven fundamental quantities in S.I system. Their symbol and unit is mentioned below.

<u>Quantity</u>	<u>Unit</u>	<u>Abbreviation</u>
Mass	Kilogram	Kg
Length	Metre	M
Time	Second	S
Temperature	Kelvin	K
Electric current	Ampere	A
Luminous intensity	Candela	Cd
Amount of substance	Mole	mol

Derived Quantities:

Quantities that can be expressed in terms of fundamental quantities are called derived quantities.

Examples of some derived quantities:

<u>Quantity</u>	<u>Unit</u>	<u>Abbreviation</u>
Area	square metre	m^2
Volume	cube metre	m^3
Velocity	metre/sec	m/s
Acceleration	metre/sec square	m/s^2
Force	Newton	$kg\cdot m/sec^2$
Work, energy & heat	Joule	N-m
Moment of inertia	kilogram metre square	$kg\cdot m^2$
Power	Watt	J/s

Systems of units:

Generally we use four systems of units.

- ♣ **Centimeter-gram-second (C.G.S) system:** In this system the units of fundamental quantities i.e. *mass*, *length* and *time* are expressed in *gram*, *centimeter* and *second* respectively.
- ♣ **Metre-kilogram-second (M.K.S) system:** In this system the units of fundamental quantities i.e. *mass*, *length* and *time* are expressed in *kilogram*, *meter* and *second* respectively.
- ♣ **Foot-pound-second (F.P.S) system:** In this system the units of fundamental quantities i.e. *mass*, *length* and *time* are expressed in *pound*, *foot* and *second* respectively.
- ♣ **International systems of units (S.I system):** This system consists of seven fundamental quantities. In this system the units of fundamental quantities i.e. *mass*, *length* and *time* are expressed in *kilogram*, *meter* and *second* respectively.

FORCE & MOMENTS

Force:

Force is something which can change the state of rest or state of motion of the body. It may also deform a body by changing its dimension. It is a vector quantity.

- ♣ Mathematically, it is given by the product of mass of a body and the acceleration produced.
i.e $F = m.a$
- ♣ The *unit of force* is Dyne (dyn) in C.G.S, Newton (N) in S.I and M.K.S. The gravitational unit of force is kilogram force (kgf) or gram force (gmf).
- ♣ $1 \text{ N} = 10^5 \text{ dyn}$, $1 \text{ kgf} = 9.81 \text{ N}$, $1 \text{ gmf} = 981 \text{ dyn}$.
- ♣ The *characteristics of force* are its magnitude, direction or line of action, point of application and nature of force.

Graphical Representation of Force :

Any force can be represented in magnitude and direction by a straight line with an arrow head. The beginning of the line represents the point of application of the force. The arrow head represents the direction of the force. The magnitude of the force is given by the length of the line drawn to scale.

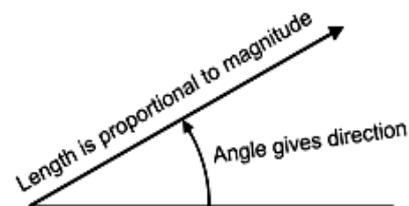

Effects of force:

- ♣ It may change the state of rest or uniform motion of the body.
- ♣ It may keep the body in equilibrium.
- ♣ It may produce internal stresses in a body.

System of Forces:

Types of force	Definition	Figure
<i>Collinear forces</i>	If the lines of action of the forces acting on the body lie on a same line, then the forces are called as Collinear forces.	
<i>Concurrent forces</i>	If the lines of action of the forces acting on the body passes through a common point, then the forces are called as concurrent forces.	
<i>Non Concurrent forces</i>	If the lines of action of the forces acting on the body don't pass through a common point, then the forces are called as concurrent forces.	

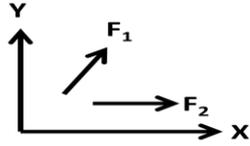
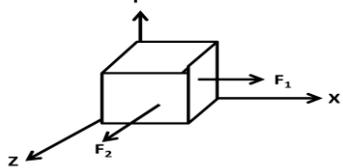
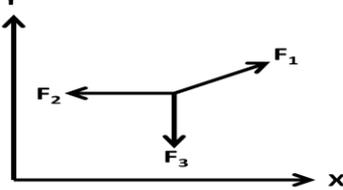
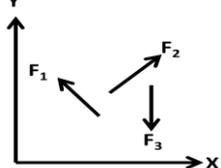
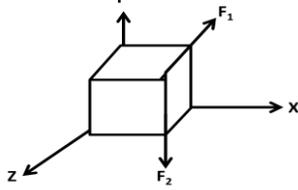
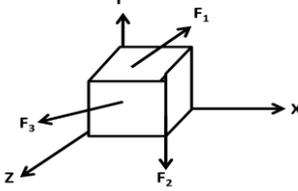
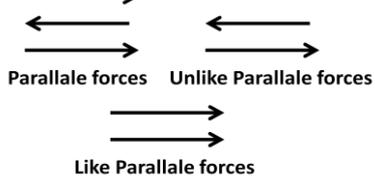
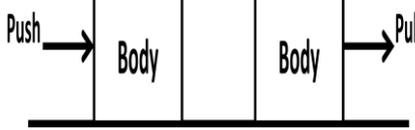
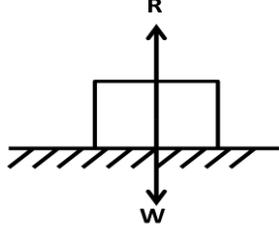
<p><i>Coplanar forces</i></p>	<p>If the lines of action of the forces acting on the body lie on the same plane, then the forces are called as Coplanar forces.</p>	
<p><i>Non Coplanar Forces</i></p>	<p>If the lines of action of the forces acting on the body don't lie on the same plane, then the forces are called as Coplanar forces.</p>	
<p><i>Coplanar – Concurrent forces</i></p>	<p>If the lines of action of the forces acting on the body lie on the same plane and also pass through a common point, then the forces are called as Coplanar-Concurrent forces.</p>	
<p><i>Coplanar-Non concurrent forces</i></p>	<p>If the lines of action of the forces acting on the body lie on the same plane but don't pass through a common point, then the forces are called as Coplanar - non concurrent forces.</p>	
<p><i>Non Coplanar-Concurrent forces</i></p>	<p>If the lines of action of the forces acting on the body don't lie on the same plane but pass through a common point, then the forces are called as Non Coplanar-Concurrent forces.</p>	
<p><i>Non Coplanar – Non Concurrent forces</i></p>	<p>If the lines of action of the forces acting on the body don't lie on the same plane and don't pass through a common point, then the forces are called as Non coplanar- non concurrent forces.</p>	
<p><i>Parallel forces</i></p>	<p>If the lines of action of all forces are parallel to each other, then the forces are called as <i>Parallel forces</i>. If all forces are acting in same direction, then the forces are called as <i>Like parallel forces</i>. If the forces are acting in different direction, then the forces are called as <i>Unlike parallel forces</i>.</p>	
<p><i>Pull & Push</i></p>	<p><i>Pull</i> is the force which acts on the body at its front to move it in the direction of force applied. <i>Push</i> is the force which acts on a body at its back to move it in the opposite direction of force applied.</p>	
<p><i>Action & Reaction</i></p>	<p><i>Action</i> is the active force and <i>Reaction</i> is the reactive force. When a body is placed on a horizontal plane, the weight of the body (W) acts in vertically downward and a reaction force (R) acts in vertically upward direction. Where W is called as the action of the body on plane and R is called as the reaction of the plane on the body.</p>	

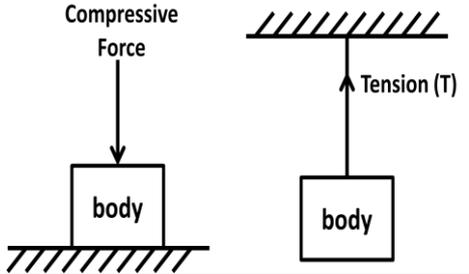
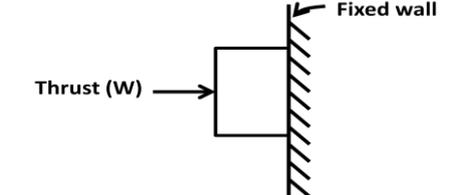
<p><i>Tension & Compression</i></p>	<p>Tension is the pull which acts on the string, rope, rod or body. Compression is the push which acts on the string, rope, rod or body. A body is said to be in tension if it is subjected to two equal and opposite pulls. A body is said to be in compression if it is subjected to two equal and opposite push.</p>	
<p><i>Thrust</i></p>	<p>When a fixed surface is acted upon by compressive force, that force is called as thrust on that surface.</p>	

Principle of transmissibility of a force:

If the point of application of force acting on a body is shifted to any other point of its line of action without changing its direction, then the effect of force remains unchanged and the equilibrium state remains unchanged. This principle is known as *Principle of Transmissibility* of force.

Principle of Superposition or Law of superposition:

The law of superposition is stated as, “the action of a given system of forces on a rigid body is not changed by adding or subtracting another system of forces in equilibrium.”

Free body diagram:

A body is said to be free body if it is isolated from all other connected bodies and supports.

Free body diagram of a body is the diagram, which is drawn by showing all the external forces and support reactions on the body and by removing the contact surfaces.

Examples of free body diagram:

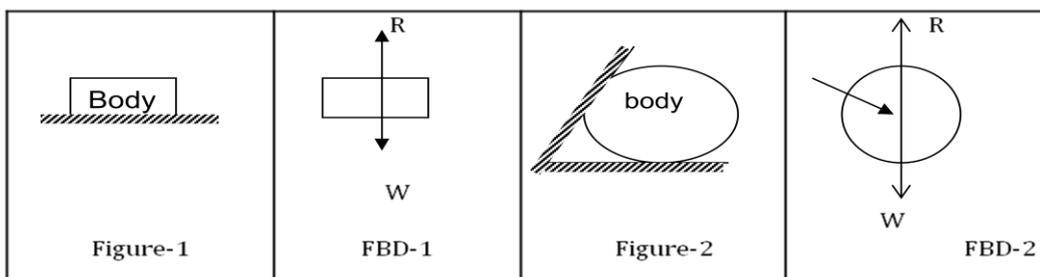

Resultant of a force:

Resultant of a force system is a single force which produces the same effect as the force system produce.

If P and Q are the two forces acting on a particle at A, then their combined effect can be replaced by a single force R. Where R is called as the resultant of P and Q. The forces P and Q are called as components of R.

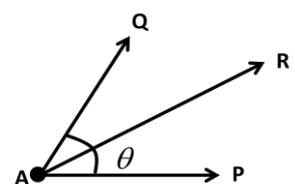

The resultant of the system of forces acting on a body can be determine by

- ♣ Analytical method: by using trigonometric method (parallelogram law) and method of resolution.
- ♣ Graphical method: by using triangle and polygon law of forces.

Composition of forces:

The process of determining the resultant force of a force system is called as *Composition of forces*.

Resolution of force:

The process of splitting up the given force into number of components is called as *Resolution of force*.

Components are classified as perpendicular and non-perpendicular components.

- ♣ Perpendicular components – If the components of a force are given by two mutually perpendicular directions, then the components are known as *perpendicular components or resolve parts* of the force.
- ♣ Non perpendicular components – If the components of a force are not given along the two mutually perpendicular directions, then such components are known as *non-perpendicular components*.

Parallelogram law of forces:

This law states that, “If two forces acting at a point are represented in magnitude and direction by the two adjacent sides of a parallelogram drawn from that point, their resultant can be represented in magnitude and direction by the diagonal of the parallelogram drawn through that point”.

Determination of resultant force:

Consider two forces P and Q, acting at a point ‘O’ as shown in figure-1. The angle between P and Q force is θ .

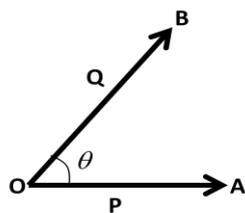

(Figure-1)

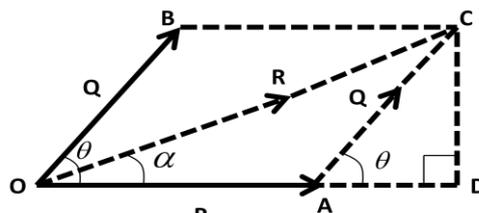

(Figure-2)

Let the two forces P and Q are represented in magnitude and direction by the sides OA and OB of a parallelogram OACB as shown in figure-2. In figure, resultant R is shown on the diagonal OC.

Draw CD perpendicular to OA extended. From figure, OA = P and AC = Q. $\angle BOA = \angle CAD = \theta$

In triangle OCD, $R = OC = \sqrt{OD^2 + CD^2} = \sqrt{(OA + AD)^2 + CD^2}$ ----- (i)

In triangle ADC, $\sin \theta = \frac{CD}{AC} \Rightarrow CD = AC \sin \theta = Q \sin \theta$
 $\cos \theta = \frac{AD}{AC} \Rightarrow AD = AC \cos \theta = Q \cos \theta$

Substituting the value of OA, AD and CD in equation-(i), we get:

$$R = \sqrt{(P + Q \cos \theta)^2 + (Q \sin \theta)^2} = \sqrt{P^2 + Q^2 \cos^2 \theta + 2PQ \cos \theta + Q^2 \sin^2 \theta}$$

$$= \sqrt{P^2 + 2PQ \cos \theta + Q^2 (\cos^2 \theta + \sin^2 \theta)} = \sqrt{P^2 + 2PQ \cos \theta + Q^2}$$

$\therefore R = \sqrt{P^2 + 2PQ \cos \theta + Q^2}$ ----- (ii)

Let R is making an angle α with P. In triangle OCD, $\tan \alpha = \frac{CD}{OD} = \frac{CD}{OA + AD}$

$\therefore \tan \alpha = \frac{Q \sin \theta}{P + Q \cos \theta}$ ----- (iii)

If R is making an angle α with Q, then we can write $\tan \alpha = \frac{P \sin \theta}{Q + P \cos \theta}$ ----- (iv)

Angle between P and Q	Resultant	Conclusion
$\theta = 0^\circ$	$R = P + Q$	P and Q are collinear and acting in same direction.
$\theta = 180^\circ$	$R = P - Q$	P and Q are collinear and acting in opposite direction.
$\theta = 90^\circ$	$R = \sqrt{P^2 + Q^2}$	P and Q are perpendicular to each other.

SOLVED PROBLEM

Que-1) Two forces 50 kN and 10 kN are act at a point O. the included angle between them is 60° . Find the magnitude and direction of the resultant force.

Ans: Let force P = 50 kN, force Q = 10 kN, angle between P and Q (θ) = 60°

Resultant of P and Q (R) = $\sqrt{P^2 + Q^2 + 2PQ \cos \theta}$
 $= \sqrt{50^2 + 10^2 + 2 \times 50 \times 10 \cos 60^\circ}$
 $= 122.5 \text{ kN}$

Direction of R $\alpha = \tan^{-1} \left(\frac{P \sin \theta}{Q + P \cos \theta} \right) = \tan^{-1} \left(\frac{50 \sin 60^\circ}{10 + 50 \cos 60^\circ} \right) = 51.05^\circ$ (Ans)

Que-2) Find the magnitude of two forces such that if they act at right angles, their resultant is $\sqrt{10}$ kN and when they act at an angle of 60° , their resultant is $\sqrt{13}$ kN.

Ans: Let P and Q are the two forces and their resultant is R.

Case-1: $\sqrt{10} = \sqrt{P^2 + Q^2} \Rightarrow P^2 + Q^2 = 10$

$$\text{Case-2: } \sqrt{13} = \sqrt{P^2 + Q^2 + 2PQ \cos 60^\circ} = \sqrt{P^2 + Q^2 + 2PQ \times \frac{1}{2}}$$

$$\Rightarrow 13 = P^2 + Q^2 + PQ = 10 + PQ$$

$$\Rightarrow PQ = 13 - 10 = 3$$

We know that; $(P+Q)^2 = P^2 + Q^2 + 2PQ$

$$\Rightarrow P + Q = \sqrt{P^2 + Q^2 + 2PQ} = \sqrt{10 + 2 \times 3} = \sqrt{16} = 4 \quad \text{----- (i)}$$

$$\text{Similarly } P - Q = \sqrt{P^2 + Q^2 - 2PQ} = \sqrt{10 - 2 \times 3} = \sqrt{4} = 2 \quad \text{----- (ii)}$$

Solving equation- (i) and (ii) we get: $P = 3 \text{ kN}$ and $Q = 1 \text{ kN}$ (Ans)

Que-3) The greatest and least resultants of two forces are respectively 17 kN and 3 kN. Determine the angle between two forces when their resultant is $\sqrt{149}$.

Ans: Let P and Q are the two forces and their resultant is R. Angle between P & Q is θ .

$$\text{Greatest resultant} = P + Q = 17 \text{ kN} \quad \text{----- (1)}$$

$$\text{Least resultant} = P - Q = 3 \text{ kN} \quad \text{----- (2)}$$

Solving equation-1 and 2 we get: $P = 10 \text{ kN}$ and $Q = 7 \text{ kN}$

$$\text{According to question; } \sqrt{149} = \sqrt{P^2 + Q^2 + 2PQ \cos \theta}$$

$$\Rightarrow 149 = P^2 + Q^2 + 2PQ \cos \theta$$

$$= 10^2 + 7^2 + 2 \times 10 \times 7 \cos \theta$$

$$= 100 + 49 + 140 \cos \theta = 149 + 140 \cos \theta$$

$$\Rightarrow \cos \theta = \frac{149 - 149}{140} = 0$$

$$\Rightarrow \theta = \cos^{-1}(0) = 90^\circ \quad \text{(Ans)}$$

Que-4) Two forces are acting at an angle of 120° . The greater force is of 40 N and the resultant is acting at 90° to the smaller force. Find the magnitude of the smaller force.

Ans: Let P is the greater force and Q is the smaller force and their resultant is R.

Angle between two forces (θ) = 120° , $P = 40 \text{ N}$

Let α = angle between R and P = $120^\circ - 90^\circ = 30^\circ$.

$$\text{We know that, } \tan \alpha = \frac{Q \sin \theta}{P + Q \cos \theta} = \frac{Q \sin 120}{40 + Q \cos 120} = \frac{Q \times 0.866}{40 + Q \times (-0.5)}$$

$$\Rightarrow \tan 30 = 0.58 = \frac{Q \times 0.866}{40 + Q \times (-0.5)} = \frac{0.866Q}{40 - 0.5Q}$$

$$\Rightarrow 40 - 0.5Q = \frac{0.866Q}{0.58} = 1.49Q$$

$$\Rightarrow 1.49Q + 0.5Q = 40 \Rightarrow 1.99Q = 40 \Rightarrow Q = 40 / 1.99 = 20.1 \text{ N} \quad \text{(Ans)}$$

EXERCISE

- Que-1)** Find the magnitude of two equal forces acting at a point with an angle of 60° between them, if the resultant is equal to $30\sqrt{3}$ N. (Ans: 30 N)
- Que-2)** Two forces of magnitudes $3P$ and $2P$ respectively acting at a point have a resultant R . If the first force is doubled, the magnitude of resultant is doubled. Find the angle between the forces $3P$ and $2P$. (Ans: 120°)
- Que-3)** In a concurrent force system, two forces are acting on a point at an angle 60° . The resultant force is 120 N and one of the forces is 80 kN. Determine the unknown force. (Ans: 57.98 kN)
- Que-4)** Two forces of magnitude P and Q are acting at a point. They are such that, if the direction of one is reversed, then the resultant turns through a right angle, show that $P = Q$.
- Que-5)** Two forces equal to $2F$ and F act on a particle. If the first be doubled and the second increased by 15 N, the direction of the resultant force remains unaltered. Find the value of F . (Ans: $F = 15$ N)
- Que-6)** The resultant of two forces $(P+Q)$ and $(P-Q)$ is $\sqrt{3P^2 + Q^2}$. Show that the forces are inclined to each other at an angle of 60° .
- Que-7)** The resultant of two forces P and Q is at right angles to P . Show that the angle between the forces is $\cos^{-1}\left(-\frac{P}{Q}\right)$.
- Que-8)** The resultant of two equal forces acting at a point also equals to P . Determine the angle between the two forces. (Ans: 120°)

Method of resolution:

- ♣ Resolve all the forces acting on the body horizontally and vertically.
- ♣ Find the sum of horizontal components (ΣH) and sum of vertical components (ΣV).
- ♣ The magnitude of resultant of forces is given by: $R = \sqrt{(\Sigma H)^2 + (\Sigma V)^2}$
- ♣ The direction of resultant is obtained at an angle θ with the horizontal from the following formula. $\tan \alpha = \frac{\Sigma V}{\Sigma H}$;

Where, α = angle made by the resultant with horizontal.

- ◆ If ΣV is positive, then $0^\circ < \theta < 180^\circ$
- ◆ If ΣV is negative, then $180^\circ < \theta < 360^\circ$
- ◆ If ΣH is positive, then $0^\circ < \theta < 90^\circ$ and $270^\circ < \theta < 360^\circ$
- ◆ If ΣH is negative, then $90^\circ < \theta < 270^\circ$

Resolution of force in rectangular coordinates in different quadrants:

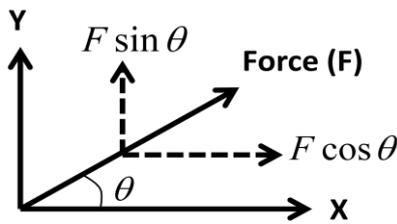

Force (F) in first quadrant

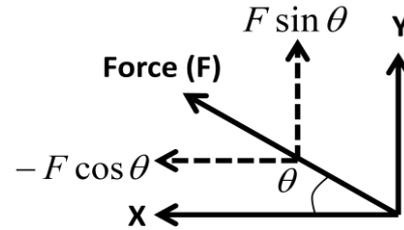

Force (F) in second quadrant

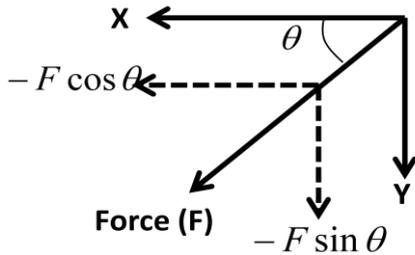

Force (F) in third quadrant

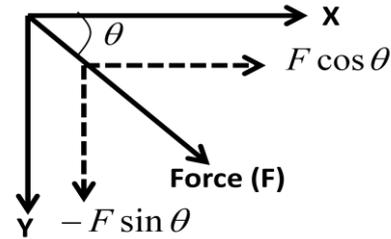

Force (F) in fourth quadrant

SOLVED PROBLEM

Que-1) A block is resting on an inclined plane of 15° . A force of 20 kN acts at 50° with the plane. Determine: (a) the horizontal and vertical components of the force (b) the components of force parallel and perpendicular to the plane.

Ans: **Data given:**

Force = 20 kN, angle of inclined plane = 15° , angle of force = 50° .

(a) Horizontal component of force = $20 \cos 65^\circ = 8.45$ kN
 Vertical component of force = $20 \sin 65^\circ = 18.13$ kN

(b) Force parallel to the plane = $20 \cos 50^\circ = 12.85$ kN
 Force perpendicular to plane = $20 \sin 50^\circ = 15.32$ kN

(Ans)

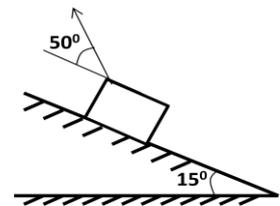

Que-2) A particle is acted upon by three forces with magnitudes 2 kN, $2\sqrt{2}$ kN and 1 kN. The first force is along horizontal direction; second makes an angle of 45° with the horizontal and the third is along the vertical direction. Determine the resultant of the given forces.

(Ans: $R = 5$ kN, $\theta = 36.9^\circ$)

Ans: Resolving all forces horizontally and vertically & by taking sum of horizontal components and sum of vertical components we get:

$$\sum H = 2 + 2\sqrt{2} \cos 45^\circ = 4 \text{ kN}$$

$$\sum V = 1 + 2\sqrt{2} \sin 45^\circ = 3 \text{ kN}$$

$$R = \sqrt{(\sum H)^2 + (\sum V)^2} = \sqrt{(4)^2 + (3)^2}$$

$$= \sqrt{25} = 5 \text{ kN}$$

$$\tan \alpha = \frac{\Sigma V}{\Sigma H} = \frac{3}{4} = 0.75$$

$$\Rightarrow \alpha = \tan^{-1}(0.75) = 36.86^\circ$$

∴ The magnitude of resultant force is 5 kN and it makes an angle of 36.86° with horizontal.

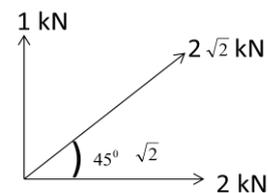

Que-3) Five forces 4, $\sqrt{3}$, 5, $\sqrt{3}$ and 3 kN respectively act at one of the angular points of a regular hexagon towards other five angular points. Find the magnitude and direction of the resultant forces.

Ans: Resolving all forces horizontally and vertically & by taking sum of horizontal components and sum of vertical components we get:

$$\Sigma H = 4 \cos 0^\circ + \sqrt{3} \cos 30^\circ + 5 \cos 60^\circ + \sqrt{3} \cos 90^\circ - 3 \cos 60^\circ = 6.5 \text{ kN}$$

$$\Sigma V = 4 \sin 0^\circ + \sqrt{3} \sin 30^\circ + 5 \sin 60^\circ + \sqrt{3} \sin 90^\circ + 3 \sin 60^\circ = 9.52 \text{ kN}$$

$$R = \sqrt{(\Sigma H)^2 + (\Sigma V)^2} = \sqrt{(6.5)^2 + (9.52)^2} = \sqrt{132.88} = 11.52 \text{ kN}$$

$$\tan \alpha = \frac{\Sigma V}{\Sigma H} = \frac{9.52}{6.5} = 1.46$$

$$\Rightarrow \alpha = \tan^{-1}(1.46) = 55.67^\circ$$

∴ The magnitude of resultant force is 11.52 kN and it makes an angle of 55.67° with the OA.

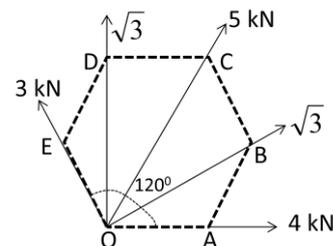

Que-4) Four horizontal wires are attached to a vertical telegraph and they exert the following pulls on the post. (i) 20 kN towards east (ii) 40 kN towards north-east (iii) 30 kN towards north (iv) 50 kN towards south-west. Find the magnitude and direction of resultant pull.

Ans: Resolving all forces horizontally and vertically & by taking sum of horizontal components and sum of vertical components we get:

$$\Sigma H = 20 \cos 0^\circ + 40 \cos 45^\circ + 30 \cos 90^\circ - 50 \cos 45^\circ = 12.92 \text{ kN}$$

$$\Sigma V = 20 \sin 0^\circ + 40 \sin 45^\circ + 30 \sin 90^\circ + 50 \sin 45^\circ = 93.63 \text{ kN}$$

$$R = \sqrt{(\Sigma H)^2 + (\Sigma V)^2} = \sqrt{(12.92)^2 + (93.63)^2} = \sqrt{8933.50} = 94.51 \text{ kN}$$

$$\tan \alpha = \frac{\Sigma V}{\Sigma H} = \frac{93.63}{12.92} = 7.24$$

$$\Rightarrow \alpha = \tan^{-1}(7.24) = 82.14^\circ$$

∴ The magnitude of resultant force is 94.51 kN and it makes an angle of 82.14° with the horizontal.

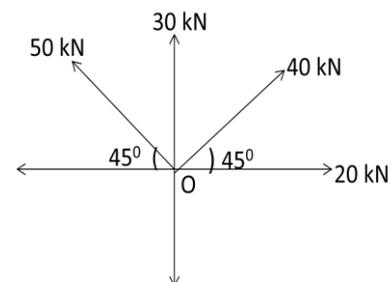

(Ans)

EXERCISE

- Que-1)** A small block of weight $Q = 44.5 \text{ N}$ is placed on an inclined plane which makes an angle $\alpha = 30^\circ$ with the horizontal. Resolve the gravity force Q into two rectangular components Q_1 and Q_2 acting parallel and normal to the inclined plane respectively.
 (Ans: $Q_1 = 22.25 \text{ N}$, $Q_2 = 38.53 \text{ N}$)
- Que-2)** Determine the magnitude of the unknown forces for the condition of equilibrium for the following force system.
 (Ans: $F_1 = 1.15 \text{ kN}$, $F_2 = 3.84 \text{ kN}$)

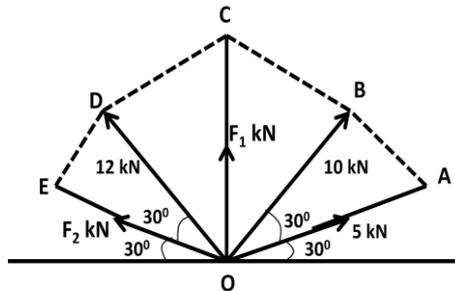

- Que-3)** A circular roller of weight W rests on a smooth horizontal plane and is kept in position by string AC as shown in the figure. The roller is pulled by a horizontal force P applied to its centre. Determine the reaction at B and the tension of the string. (Ans: $P \tan \alpha + W$, $P/\cos \alpha$)

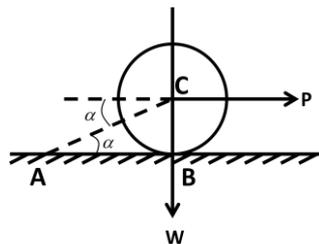

Principle of resolution of a Force:

It states that, “the algebraic sum of the resolved parts of a number of forces in a given direction is equal to the resolved part of their resultant in the same direction”.

Triangle law of forces:

It states that, “if two forces acting simultaneously on a particle be represented in magnitude and direction by the two sides of a triangle taken in order, then their resultant may be represented in magnitude and direction by the third side of the triangle taken in opposite order”.

Polygon law of forces:

It states that, “if a number of concurrent forces acting simultaneously on a particle be represented in magnitude and direction by the sides of a polygon taken in order, then their resultant may be represented in magnitude and direction by the closing side of the polygon taken in opposite order”.

<p>If P_1, P_2, P_3 and P_4 forces are acting simultaneously at a particle at O, be represented in magnitude and direction by the sides oa, ab, bc, cd of a polygon respectively; then their resultant is represented by the closing side ‘do’ of the polygon in opposite direction.</p>	<p>(Space diagram)</p>	<p>(Vector diagram)</p>
---	------------------------	-------------------------

Equilibrium of a particle:

- ♣ A particle is said to be in equilibrium when the resultant of all the forces acting on it is zero or the net forces acting on the body is equal to zero.
- ♣ When all the forces that act upon a body are balanced, then the body is said to be in a state of *equilibrium*.

The forces are considered as balanced if the rightward forces are balanced by the leftward forces and the upward forces are balanced by the downward forces i.e. net effect of forces on the body balancing each other.

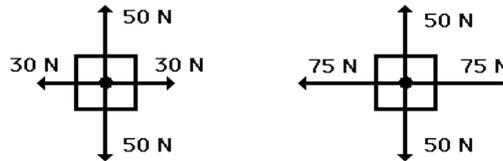

These two objects are at equilibrium since the forces are balanced. However, the forces are not equal.

- ♣ In statics a body is said to be in equilibrium, when it come back to its original position after it is slightly displaced from its rest position.
- ♣ The single force which brings the force system to equilibrium is called as an *equilibrant*.
- ♣ Analytical Conditions of equilibrium:

The algebraic sum of horizontal and vertical components of the forces acting on the body must be zero. (i.e. $\Sigma H = 0$ & $\Sigma V = 0$).

If a body is turning or rotating, then the algebraic sum of moments must be zero and the net couple acting on the body must be zero. (i.e. $\Sigma M = 0$).

- ♣ Graphical conditions of equilibrium:

The force or vector diagram must be closed.

Lami's theorem:

It states that, "if three coplanar concurrent forces acting at a point be in equilibrium, then each force is proportional to the sine of the angle between the other two forces".

Explanation: Let three forces P, Q and R are acting at a point 'O'. Let α = angle between R and Q, β = angle between Q and P, γ = angle between R and P.

According to Lami's theorem:
$$\frac{P}{\sin \alpha} = \frac{Q}{\sin \beta} = \frac{R}{\sin \gamma}$$

Proof:

Consider three coplanar concurrent forces P, Q and R acting at a point 'O' as shown in *figure-1*. Let α = angle between R and Q, β = angle between Q and P, γ = angle between R and P.

Consider a parallelogram OACB as shown in *figure-2* drawn from figure -1. The side OA, OB, diagonal OC represents the forces P, Q and R respectively.

From figure:

$$OA = BC = P; OB = AC = Q;$$

$$\angle AOC = 180 - \beta;$$

$$\angle ACO = \angle BCO = 180 - \alpha$$

In triangle OAC;

$$\angle CAO = 180^\circ - (\angle AOC + \angle ACO)$$

$$= 180^\circ - (180 - \beta + 180 - \alpha)$$

$$\Rightarrow \angle CAO = \alpha + \beta - 180^\circ$$

But $\alpha + \beta + \gamma = 360^\circ$

$$\Rightarrow \alpha + \beta - 180^\circ = 180 - \gamma$$

$$\Rightarrow \angle CAO = 180 - \gamma$$

We know that in triangle OAC,

$$\frac{OA}{\sin \angle ACO} = \frac{AC}{\sin \angle AOC} = \frac{OC}{\sin \angle CAO}$$

$$\Rightarrow \frac{P}{\sin (180 - \alpha)} = \frac{Q}{\sin (180 - \beta)} = \frac{R}{\sin (180 - \gamma)}$$

$$\therefore \frac{P}{\sin \alpha} = \frac{Q}{\sin \beta} = \frac{R}{\sin \gamma} \quad (\text{Proved})$$

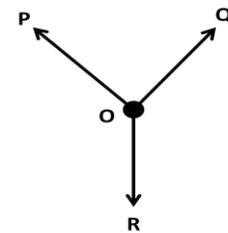

(Figure-1)

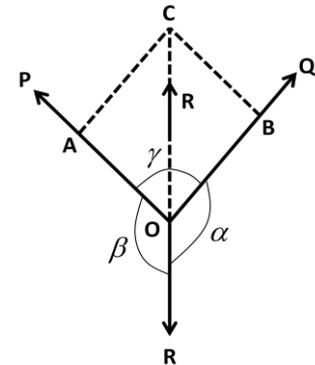

(Figure-2)

SOLVED PROBLEM

Que-1) An electric light fixture of weight 200 N is supported as shown in figure. Determine the tensile forces in the wires BA and BC as shown in the figure.

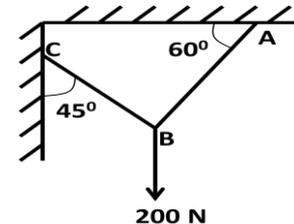

Ans: Consider the free body diagram at B.

- Let, T_{BC} = tension in wire BC,
- T_{BA} = tension in wire BA,
- W = weight of light fixture = 200 N

The point B is in equilibrium under the action of forces T_{BC} , T_{BA} and W .

Applying Lami's theorem to point B we get;

$$\frac{T_{BA}}{\sin(90^\circ + 45^\circ)} = \frac{T_{BC}}{\sin(90^\circ + 60^\circ)} = \frac{200}{\sin 75^\circ}$$

$$\Rightarrow \frac{T_{BA}}{\sin(135^\circ)} = \frac{T_{BC}}{\sin(150^\circ)} = \frac{200}{\sin 75^\circ} \Rightarrow \frac{T_{BA}}{0.707} = \frac{T_{BC}}{0.5} = \frac{200}{0.965}$$

$$\Rightarrow T_{BA} = 0.707 \times \frac{200}{0.965} = 146.5 \text{ N} \quad \text{and} \quad \Rightarrow T_{BC} = 0.5 \times \frac{200}{0.965} = 103.6 \text{ N} \quad (\text{Ans})$$

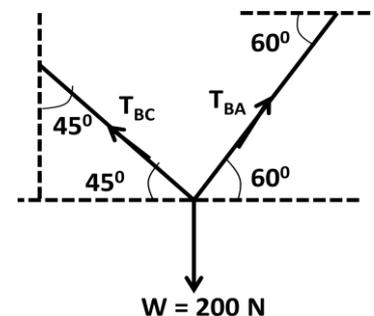

Que-2) A smooth circular cylinder of radius 2 m is lying in a triangular groove, one side of which makes 20° angle and other 30° angle with the horizontal. Find the reactions at the surfaces of contacts, if there is no friction and the cylinder weights 200 N.

Ans: Let, R_A = reaction at A and R_B = reaction at B. W = weight of the body = 200 N

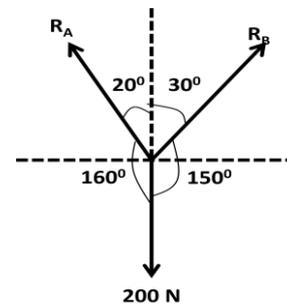
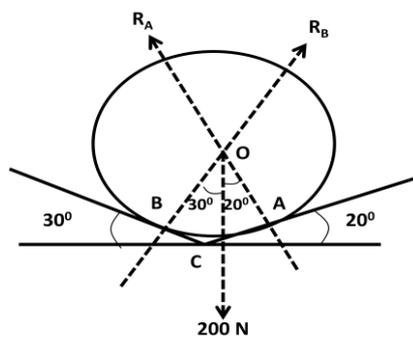

(Free body diagram)

Applying Lami's theorem to point 'O' we get;

$$\Rightarrow \frac{R_A}{\sin(150^\circ)} = \frac{R_B}{\sin(160^\circ)} = \frac{200}{\sin 50^\circ} \Rightarrow \frac{R_A}{0.5} = \frac{R_B}{0.342} = \frac{200}{0.766}$$

$$\Rightarrow R_A = 0.5 \times \frac{200}{0.766} = 130.54 \text{ N} \quad \text{and} \quad \Rightarrow R_B = 0.342 \times \frac{200}{0.766} = 89.29 \text{ N} \quad (\text{Ans})$$

Que-3) Two rollers of same diameter are supported by an inclined plane and vertical wall as shown in the figure. The upper and the lower rollers are respectively 300 N and 400 N in weight,. Find the reactions at points of contact A, B, C and D. Assume all the surfaces to be smooth.

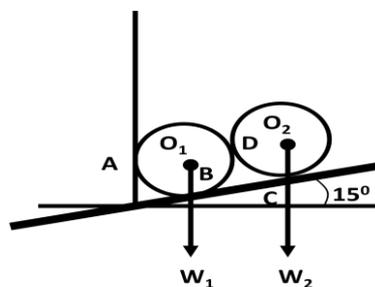

Ans: The upper roller remains in equilibrium under the action of following forces.
 Weight (W_2) = 300 N, reaction at C (R_C), and reaction of lower roller in the direction O_1O_2 (R_D).
 Consider the equilibrium of upper roller.

Applying Lami's theorem to point O_2 , we get;

$$\Rightarrow \frac{R_D}{\sin 165^\circ} = \frac{R_C}{\sin 105^\circ} = \frac{300}{\sin 90^\circ}$$

$$\Rightarrow \frac{R_D}{0.258} = \frac{R_C}{0.965} = \frac{300}{1}$$

$$\Rightarrow R_D = 0.258 \times 300 = 77.4 \text{ N} \quad \text{and}$$

$$\Rightarrow R_C = 0.965 \times 300 = 289.5 \text{ N}$$

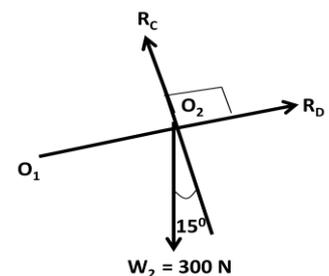

The lower roller remains in equilibrium under the action of following forces.
 Weight (W_1) = 400 N, reaction at A (R_A), reaction at B (R_B) and reaction of upper roller in the direction O_1O_2 (R_D).
 Consider the equilibrium of lower roller.

Resolving the forces along O_1O_2 we get;
 $R_A \cos 15 - W_1 \sin 15 - R_D = 0$
 $\Rightarrow R_A \times 0.966 - 400 \times 0.259 - 77.4 = 0$
 $\Rightarrow R_A = 187.37 \text{ N}$.

Resolving the forces perpendicular to O_1O_2 we get;
 $R_B - R_A \sin 15 - W_1 \cos 15 = 0$
 $\Rightarrow R_B = R_A \sin 15 + W_1 \cos 15$
 $\Rightarrow R_B = 187.37 \times 0.258 + 400 \times 0.965$
 $\Rightarrow R_B = 434.34 \text{ N}$

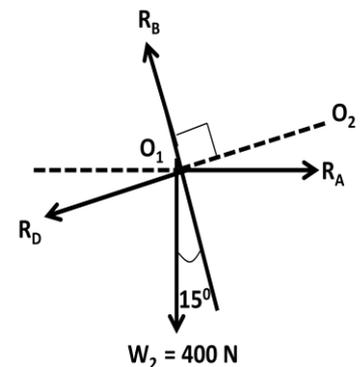

EXERCISE

Que-1) A body of weight 70 kN is suspended by two strings whose lengths are 6 cm and 8 cm from two points in the same horizontal level. The horizontal distance between the two points is 10 cm. determine the tensions of the strings. (Ans: 42 kN, 56 kN)

Que-2) A roller of weight 1000 N is kept on a smooth inclined plane and is prevented from moving down by a rope as shown in the figure. Find the tension in the rope and the reaction at the point of contact A. (Ans: 731.8 N, 896.4 N)

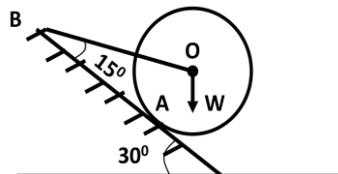

Que-3) Two cylinders rest in a channel as shown in the figure. The bigger cylinder has a diameter of 180 mm and weighs 500 N, where as the smaller cylinder has a diameter of 100 mm and weighs 200 N. If the bottom width of the box is 180 mm, with one side vertical and the other inclined at 60° , determine the reactions at all the four points of contact.

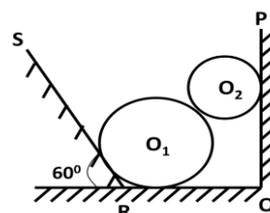

Moment of Force:

When a force acts upon a body to turn it with respect to a point, the turning effect of force is called as moment of the force.

- ♣ The product of magnitude of force and the perpendicular distance of the line of action of the force from a point is known as moment of the force about that point.
- ♣ The unit of moment in S.I system is N-m.

♣ Calculation of moment:

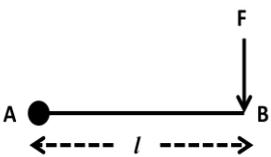
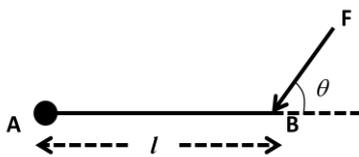
	
<p>Consider a force 'F' acting at a point B of the bar of length 'l'. Moment of the force about point A = force × distance = $F \times l$</p>	<p>Consider a force 'F' acting at an angle 'Θ' at a point B of the bar of length 'l'. Moment of the force about point A = Force × distance = $F \sin \Theta \times l$</p>

♣ Clockwise moment – It is the moment of a force which produces the turning effect of the body in clockwise direction. The clockwise moment is taken as positive

♣ Anticlockwise moment – It is the moment of a force which produces the turning effect of the body in anticlockwise direction. The anticlockwise moment is taken as negative.

♣ Graphical representation of moment:

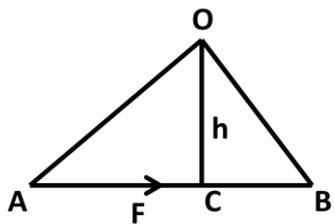
<p>Consider a force F represented in magnitude and direction by the line AB. Let O is the point about which moment is required. Let OC is the perpendicular distance of O from AB. Join OA and OB to complete the triangle OAB.</p> <p style="text-align: center;">Moment of force F about point O = $F \times h = AB \times OC$ $= 2 \times \text{area of triangle OAB}$</p>	
--	--

♣ Law of moments:

The principle of moment states that, “if a body is in equilibrium under the action of a number of parallel forces, the sum of the clockwise moments about any point must be equal to the sum of anti-clockwise moments about the same point”.

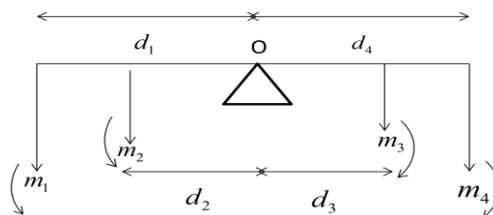

According to the principle of moments,

Sum of anti-clockwise moments = sum of clockwise moments

From figure, $m_1 d_1 + m_2 d_2 = m_3 d_3 + m_4 d_4$

Couple:

Two equal and opposite parallel forces acting at different points in a body forms a couple.

♣ A body acted upon by the couple will rotate the body in clockwise direction or anti-clockwise direction.

- ♣ Steering wheel and pedals of bicycles are the examples for couple, where the two forces are equal but acting in opposite direction.
- ♣ Moment of the couple: It is the product of one of the forces and the arm of the couple.
- ♣ Types of couple:

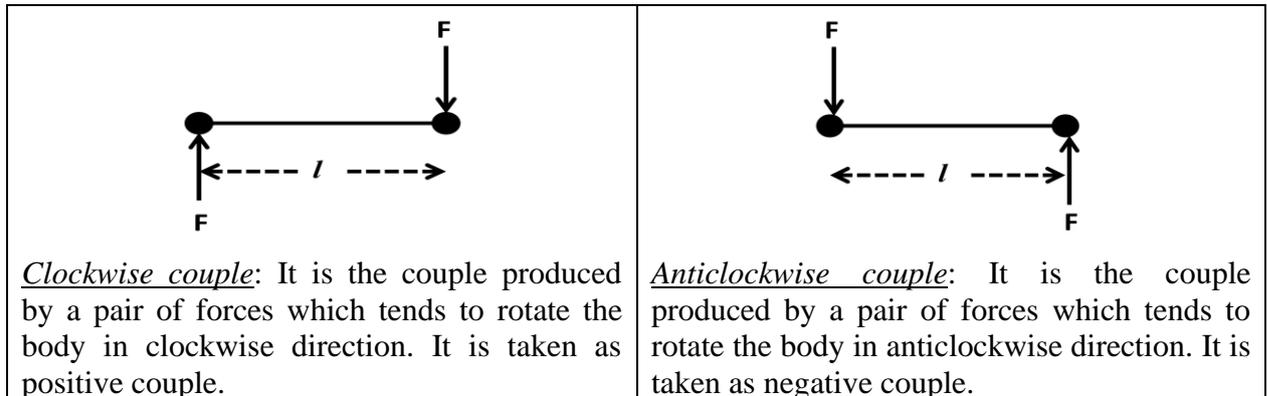

- ♣ The algebraic sum of the forces forming the couple is zero.
- ♣ A couple can be balanced by another couple of equal magnitude and opposite reaction.
- ♣ Examples of couple: opening or closing of a water tap, turning of the cap of a pen.

Varignon’s theorem:

It states that, “if a number of coplanar forces are acting simultaneously on a particle; the algebraic sum of moments of all the forces about any point is equal to the moment of their resultant force about the same point”.

Proof:

Consider two coplanar forces P and Q be represented in magnitude and direction by the sides AB and AD of the parallelogram as shown in figure. The diagonal AC represents the resultant of forces in magnitude and direction.

Let ‘O’ be any point as O, D and C lie on same line.
Join OD, OA and OB.

Moment of force P about point ‘O’ = 2 × area of triangle AOB
 Moment of force Q about point ‘O’ = 2 × area of the triangle AOC
 Moment of force R about the point ‘O’ = 2 × area of the triangle AOD

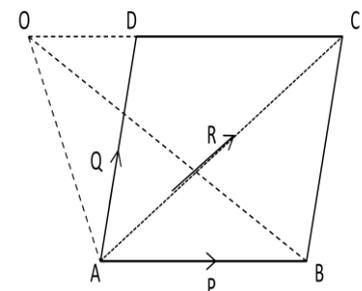

From geometry of figure:

$$\begin{aligned} \text{Area of } \Delta AOD &= \text{area of } \Delta AOC + \text{area of } \Delta ACD \\ \Rightarrow 2 \times \text{Area of } \Delta AOD &= (2 \times \text{area of } \Delta AOC) + (2 \times \text{area of } \Delta ACD) \\ \text{but, area of } \Delta ACD &= \text{area of } \Delta ADB = \text{area of } \Delta AOB \\ \text{so we may write,} \\ \Rightarrow 2 \times \text{Area of } \Delta AOD &= (2 \times \text{area of } \Delta AOC) + (2 \times \text{area of } \Delta AOB) \\ \Rightarrow \text{Moment of R about O} &= \text{Moment of Q about O} + \text{Moment of P about O} \end{aligned}$$

∴ Hence the algebraic sum of moments of two forces P and Q about point O is equal to the moment of the resultant R about the same point O. **(Proved)**

SOLVED PROBLEM

Que-1) A horizontal member is subjected to a system of parallel forces as shown in figure. Determine the magnitude and position of the resultant force.

Ans: Magnitude of resultant force:

$$\text{Resultant} = -250 + 200 - 400 + 800 = 350 \text{ N}$$

Position of resultant force:

Let x = distance of resultant from A

Consider the sum of moment about point A;

$$R \times x = 800 \times 9 - 400 \times 6 + 200 \times 3 \Rightarrow 350x = 5400 \Rightarrow x = 5400 / 350 = 15.42 \text{ m}$$

\therefore The magnitude of R is 350 N acting upward and it is at a distance 15.42 m from A.

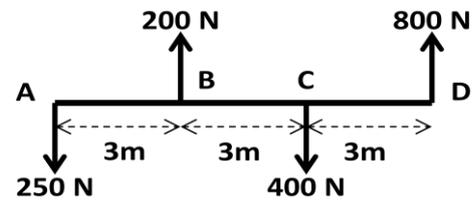

Que-2) Three forces of $4P$, $5P$ and $6P$ are acting along the three edges of an equilateral triangle of 100 mm side taken in order. Determine the magnitude and position of the resultant force.

Ans: Consider the equilateral triangle ABC as shown in figure.

Resolving all forces horizontally and taking their sum;

$$\begin{aligned} \sum H &= 4P - 5P \cos 60 - 6P \cos 60 = 4P - 5P(0.5) - 6P(0.5) \\ &= 4P - 2.5P - 3P = -1.5P \end{aligned}$$

Resolving all forces vertically and taking their sum;

$$\begin{aligned} \sum V &= 5P \sin 60 - 6P \sin 60 = 5P(0.866) - 6P(0.866) \\ &= 4.33P - 5.19P = -0.86P \end{aligned}$$

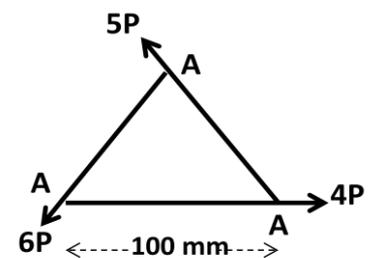

$$\text{Resultant } R = \sqrt{(\sum H)^2 + (\sum V)^2} = \sqrt{(-1.5P)^2 + (-0.86P)^2} = \sqrt{2.25P^2 + 0.73P^2}$$

$$= \sqrt{2.98P^2} = 1.72P \quad (\text{magnitude of } R)$$

Let x = perpendicular distance between point B and the line of action of resultant force

Consider sum of moment of forces about point B and equating with zero.

$$1.72P \times x = 5P \sin 60 \times 100 = 433.012P \Rightarrow x = \frac{433.012}{1.72} = 251.75 \text{ mm}$$

\therefore The resultant of forces R is at a distance of 251.75 mm from point B. (position of R)

EXERCISE

Que-1) A uniform wooden plank MN of length 5 m weighs 50 N. It is supported at end M at a point S, 1 m from the other end N. Determine the maximum weight W that can be placed at the end N so that the plank does not topple. (Ans: 75 N)

Que-2) For the following system of forces determine the magnitude, direction and position of the resultant force. (Ans: 22.19 kN, 68.94° , 3.30 m)

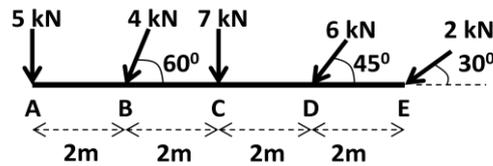

Various types of supports and their reactions:

Ball Support:

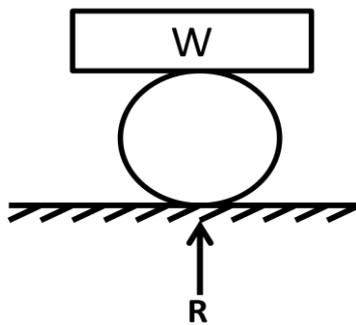

Roller Support:

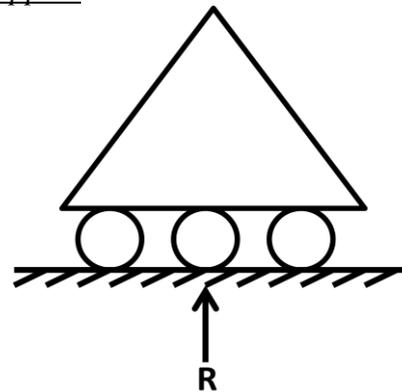

Hinged Support:

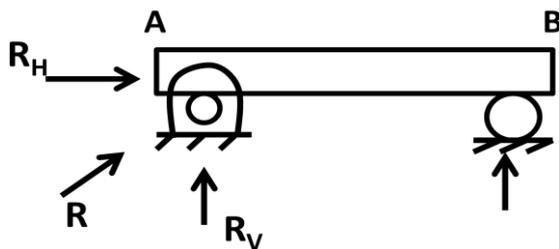

Built-in Support:

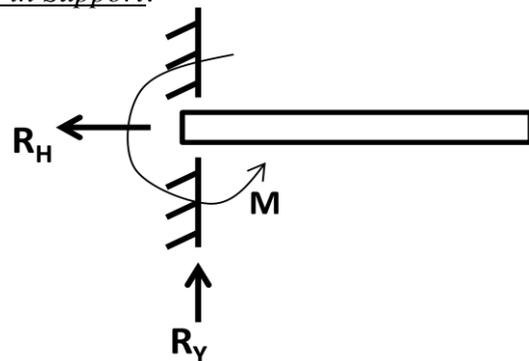

FRICTION

(Chapter 2)

Friction:

The amount of resistance force developed between two surfaces of contact when one body moves over another is called as *friction*. *Force of friction* is an opposing force which resists the motion of one body over another and it always acts in the direction opposite to the direction of applied force.

Factors influencing friction:

- ♣ Type of material
- ♣ Roughness of the surfaces of contact
- ♣ Weight of the moving body
- ♣ Nature of motion of the body

Different types of friction:

- ❖ On the basis of nature of material friction can be classified as *dry* and *fluid friction*.
- ❖ On the basis of state of rest or motion friction can be classified as *static* and *dynamic friction*.
- ♣ **Static friction:** There is a limit of frictional force beyond which it can't increase. When the applied force is less than this limiting friction, the body remains at rest and when the applied force is more than this limiting friction, the body comes in motion. This friction is called as static friction.
- ♣ **Dynamic friction:** It is the friction experienced by a body, when the body is in motion. It is less than the static friction. Dynamic friction is further classified as:
 - Sliding friction: It is the friction experienced by a body, when it is sliding over another body.
 - Rolling friction: It is the friction experienced by a body when it is rolling over another body.

Laws of static friction:

- ♣ The force of friction is directly proportional to normal reaction and always opposite in direction of motion.
- ♣ The magnitude of the limiting friction (F) bears a constant ratio to the normal reaction (R_N) between the two surfaces. i.e. $F / R_N = \text{Constant}$
- ♣ The force of friction is independent of the area of contact between the two surfaces.
- ♣ The force of friction depends upon the roughness or smoothness of the body.
- ♣ The force of friction is independent of sliding velocity.

Limiting friction:

It is the maximum value of frictional force experienced by the body, when the body just begins to slide over the surface of another body.

Coefficient of friction:

It is the ratio between the limiting friction (F) and the normal reaction (R_N). It is denoted by ' μ '.

i.e. $\mu = F / R_N$

- ♣ If F is the force necessary to start sliding, then μ is known as coefficient of static friction.
- ♣ If F is the force necessary to maintain sliding of a moving body, then μ is known as coefficient of kinetic friction.

Case – 2

Consider a body moving up the inclined plane which is inclined with an angle ‘ α ’ with the horizontal plane. Consider P is the effort applied parallel to the horizontal plane.

When the body slides downward:

Let, W = weight of the body α = angle of inclination
 ϕ = limiting angle of friction P = effort required R_N = normal reaction

Resolving all the forces perpendicular the plane,

$$R_N = W \cos \alpha + P \sin \alpha \quad \text{---- (i)}$$

Resolving the forces parallel to the plane,

$$P \cos \alpha = W \sin \alpha - \mu R_N \quad \text{---- (ii)}$$

Putting the value of R_N in equation-(ii), we get

$$\begin{aligned} P \cos \alpha &= W \sin \alpha - \mu (W \cos \alpha + P \sin \alpha) \\ &= W \sin \alpha - \mu W \cos \alpha - \mu P \sin \alpha \\ \Rightarrow P \cos \alpha + \mu P \sin \alpha &= W \sin \alpha - \mu W \cos \alpha \\ \Rightarrow P (\cos \alpha + \mu \sin \alpha) &= W (\sin \alpha - \mu \cos \alpha) \end{aligned}$$

$$\Rightarrow \boxed{P = W \times \frac{\sin \alpha - \mu \cos \alpha}{\cos \alpha + \mu \sin \alpha}} \quad \text{---- (iii)}$$

Replacing the value, $\mu = \frac{\sin \phi}{\cos \phi}$

$$\Rightarrow P = W \times \frac{\sin \alpha - \frac{\sin \phi}{\cos \phi} \cdot \cos \alpha}{\cos \alpha + \frac{\sin \phi}{\cos \phi} \cdot \sin \alpha}$$

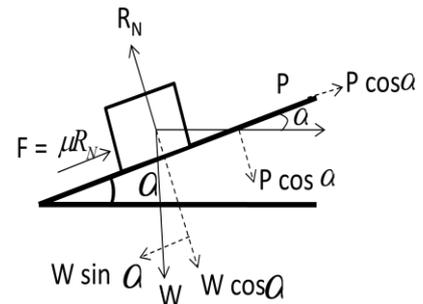

$$\Rightarrow P = W \times \left(\frac{\sin \alpha \cdot \cos \phi - \sin \phi \cdot \cos \alpha}{\cos \alpha \cdot \cos \phi + \sin \alpha \sin \phi} \right)$$

$$\Rightarrow P = \frac{W \sin (\alpha - \phi)}{\cos (\alpha - \phi)}$$

$$\Rightarrow \boxed{P = W \tan (\alpha - \phi)}$$

$$\text{or } \boxed{W \tan (\phi - \alpha)} \quad \text{---- (iv)}$$

When the body moves up:

Let, W = weight of the body α = angle of inclination
 ϕ = limiting angle of friction P = effort required R_N = normal reaction

Resolving all the forces perpendicular the plane,

$$R_N = W \cos \alpha + P \sin \alpha \quad \text{---- (i)}$$

Resolving the forces parallel to the plane,

$$P \cos \alpha = W \sin \alpha + \mu R_N \quad \text{---- (ii)}$$

Putting the value of R_N in equation-(ii), we get:

$$\begin{aligned} P \cos \alpha &= W \sin \alpha + \mu (W \cos \alpha + P \sin \alpha) \\ &= W \sin \alpha + \mu W \cos \alpha + \mu P \sin \alpha \\ \Rightarrow P \cos \alpha - \mu P \sin \alpha &= W \sin \alpha + \mu W \cos \alpha \\ \Rightarrow P (\cos \alpha - \mu \sin \alpha) &= W (\sin \alpha + \mu \cos \alpha) \end{aligned}$$

$$\Rightarrow \boxed{P = W \times \frac{\sin \alpha + \mu \cos \alpha}{\cos \alpha - \mu \sin \alpha}} \quad \text{---- (iii)}$$

Replacing the value, $\mu = \frac{\sin \phi}{\cos \phi}$ we get:

$$\Rightarrow P = W \times \frac{\sin \alpha + \frac{\sin \phi}{\cos \phi} \cdot \cos \alpha}{\cos \alpha - \frac{\sin \phi}{\cos \phi} \cdot \sin \alpha}$$

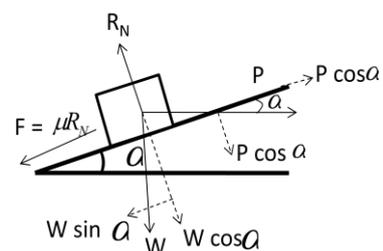

$$\Rightarrow P = W \times \left(\frac{\sin \alpha \cdot \cos \phi + \sin \phi \cdot \cos \alpha}{\cos \alpha \cdot \cos \phi - \sin \alpha \sin \phi} \right)$$

$$\Rightarrow P = \frac{W \sin (\alpha + \phi)}{\cos (\alpha + \phi)}$$

$$\Rightarrow \boxed{P = W \tan (\alpha + \phi)} \quad \text{---- (iv)}$$

EXERCISE

- Problem-1:** A body weighing 20 kN resting on a rough horizontal plane can just be moved by a horizontal force of 5 kN. Determine the coefficient of friction and total reaction.
- Problem-2:** A body of weight 300 N is lying on a rough horizontal plane having a coefficient of friction as 0.3. Find the magnitude of force, which can move the body; while acting at an angle of 25° with the horizontal.
- Problem-3:** A body resting on a horizontal plane can be moved slowly along the plane by a horizontal force of 10 kN. A force of 9 kN inclined at 30° to the horizontal direction will suffice to move the block along the same direction. Determine the coefficient of friction and weight of the body.
- Problem-4:** A body resting on a rough horizontal plane required a pull of 180 N inclined at 30° to the plane just to move it. It was found that a push of 220 N inclined at 30° to the plane just moved the body. Determine the weight of the body and coefficient of friction.
- Problem-5:** A body of weight 500 N is laying on a rough plane inclined at an angle of 25° with the horizontal. It is supported by an effort P parallel to the inclined plane. Determine the maximum and minimum values of force P for which the equilibrium can exist, if the angle of friction is 20° .
- Problem-6:** An object of weight 100 N is kept in position on a plane inclined 25° to the horizontal by a horizontally applied force. If the coefficient of friction of the surface of the inclined plane is 0.25, determine the maximum and minimum magnitude of force for which equilibrium can exist.
- Problem-7:** A force of 150 N is applied just to move a body up an inclined plane of angle 10° parallel to the plane. When the angle of inclination of the plane is increased to 30° , the force required parallel to the plane becomes 300 N. What is the weight of the body and coefficient of friction?
- Problem-8:** What is the value of P in the system shown in figure to cause the motion of a 500 N block to right side? Assume the pulley is smooth and the coefficient of friction between other contact surfaces is 0.20.

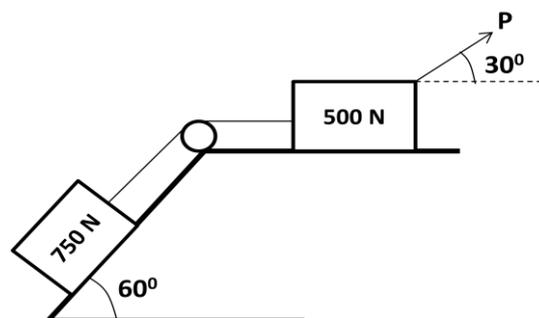
**Ladder friction:**

A ladder is supported at its two ends where friction plays an important role. Consider a ladder AB whose one end (A) is supported on ground/floor and the other end (B) is supported on wall as shown in figure.

- Let, W = weight of the ladder AB = length of ladder = l
 R_A = reaction force at A. R_B = reaction force at B.
 F_A = friction at the end A between the floor and ladder.
 F_B = friction at the end B between the wall and ladder.

μ_A = coefficient of friction between floor and ladder.

μ_B = coefficient of friction between wall and ladder.

For equilibrium of ladder the sum of horizontal forces and sum of vertical forces must be zero.

Considering $\sum H = 0$, we get

$$F_A = \mu_A R_A = R_B \quad \text{----- (1)}$$

Considering $\sum V = 0$, we get

$$R_A + F_B = W$$

$$\Rightarrow R_A + \mu_B R_B = W \quad \text{----- (2)}$$

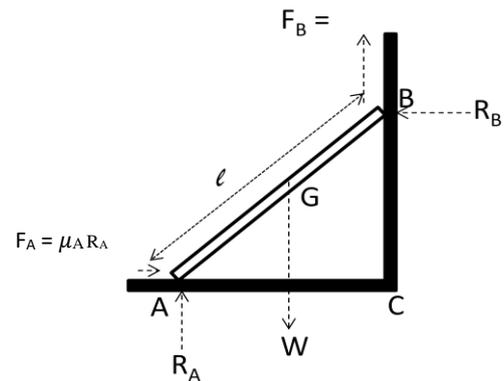

SOLVED PROBLEM

Problem-1: A uniform ladder of length 3.25 m and weighing 250 N is placed against a smooth vertical wall with its lower end 1.25m from the wall. The coefficient of friction between the ladder and floor is 0.3. What is the frictional force acting on the ladder at the point of contact between the ladder and the floor? Show that the ladder will remain in equilibrium in this position.

Solution: Data Given:

Length of ladder (l) = 3.25 m

Weight of ladder (W) = 250 N

AC = distance between lower end of ladder and wall = 1.25m

Coefficient of friction between ladder and floor at A = $\mu_A = 0.3$

Let F_A = frictional force at A = $\mu_A R_A$

R_A = normal reaction at A

There is no friction between ladder and wall at B.

Resolving the forces vertically and equating the sum to zero we get: $R_A = W = 250$ N

From figure: $BC = \sqrt{(3.25)^2 - (1.25)^2} = 3$ m

Taking moment about B and equating the sum of moments to zero we get:

$$(F_A \times 3) + (250 \times 0.625) - (R_A \times 1.25) = 0$$

$$\Rightarrow F_A = \frac{250 \times 1.25 - 250 \times 0.625}{3} = 52.1 \text{ N} \quad \text{(ANS)}$$

We know that: $F_A = \mu_A R_A = 0.3 \times 250 = 75$ N

\therefore As the force of friction available i.e. 75 N is more than the force of friction required to keep the ladder in equilibrium, thus the ladder will remain in equilibrium.

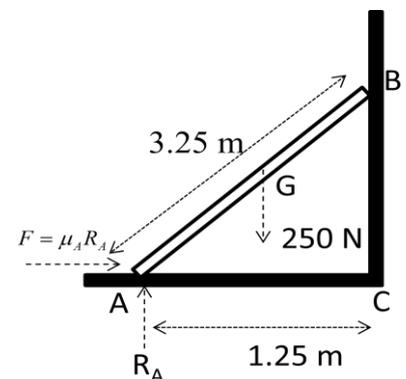

Problem-2: A ladder 5 meters long rest on a horizontal ground and leans against a smooth vertical wall at an angle 70° with the horizontal. The weight of the ladder is 900 N and acts at its middle. The ladder is at the point of sliding, when a man weighing 750 N stands on the rung 1.5 meter from the bottom of the ladder. Calculate the coefficient of friction between the ladder and the floor.

Solution: Date Given:

Length of ladder AB (l) = 5 m
 Weight of ladder (W_1) = 900 N
 Weight of man (W_2) = 700 N
 Distance between lower end of ladder and the point where the man stands = 1.5m
 Let:
 Coefficient of friction between ladder and floor at A = μ_A
 Frictional force at A (F_A) = $\mu_A R_A$
 Normal reaction at A = R_A
 There is no friction between ladder and wall at B.

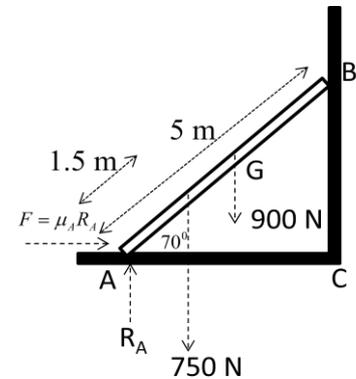

Resolving the forces vertically and equating the sum of forces with zero we get:

$$R_A = 900 + 750 = 1650 \text{ N}$$

Force of friction at A = $F_A = \mu_A R_A = 1650 \mu_A$ ----- (1)

Taking the moment about B and equating the sum of moments with zero we get:

$$R_A \times 5 \sin 20^\circ - F_A \times 5 \cos 20^\circ - 900 \times 2.5 \sin 20^\circ - 750 \times 3.5 \sin 20^\circ = 0$$

$$\Rightarrow R_A \times 5 \sin 20^\circ = F_A \times 5 \cos 20^\circ + 900 \times 2.5 \sin 20^\circ + 750 \times 3.5 \sin 20^\circ$$

$$\Rightarrow R_A \times 5 \sin 20^\circ = \mu_A R_A \times 5 \cos 20^\circ + 900 \times 2.5 \sin 20^\circ + 750 \times 3.5 \sin 20^\circ$$

$$\Rightarrow 1650 \times 5 \sin 20^\circ = \mu_A \times 1650 \times 5 \cos 20^\circ + 900 \times 2.5 \sin 20^\circ + 750 \times 3.5 \sin 20^\circ$$

$$\Rightarrow \mu_A \times 1650 \times 5 \cos 20^\circ = 1650 \times 5 \sin 20^\circ - 900 \times 2.5 \sin 20^\circ - 750 \times 3.5 \sin 20^\circ$$

$$\Rightarrow \mu_A = \frac{1650 \times 5 \sin 20^\circ - 900 \times 2.5 \sin 20^\circ - 750 \times 3.5 \sin 20^\circ}{1650 \times 5 \cos 20^\circ} = 0.15 \quad \text{(ANS)}$$

Wedge friction:

A wedge is a triangular or trapezoidal cross section element made up of metal or wood. It is used for lifting heavy loads, for tightening fits or keys of shaft etc.

When lifting loads, wedge is placed below the load and a horizontal force P is applied. The wedge moves towards left and the load moves upward.

In figure the position of wedge and load is shown. There is a sliding at the surfaces AB, AC and ED.

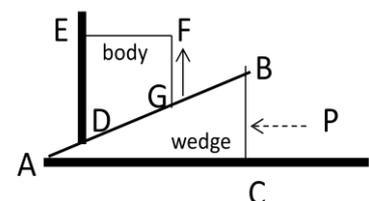

In figure the forces acting on the wedge and the body are shown.

In figure:

W = weight of the body DEFG

P = force required to lift the body

μ = coefficient of friction on the planes AB, AC and DE
= $\tan\phi$

R_1 = resultant of normal reaction and force of friction at the inclined plane AB

R_2 = resultant of normal reaction and force of friction at the horizontal plane AC

F_1 = frictional force at the inclined plane AB

F_2 = frictional force at the horizontal plane AC

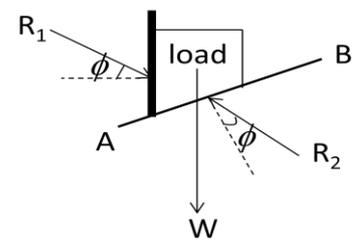

Forces on the body DEFG

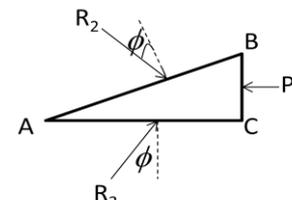

Forces on the wedge ABC

SOLVED PROBLEM

Problem-3: A block weighing 1500 N, overlying a 10° wedge on a horizontal floor and leaning against a vertical wall is to be raised by applying a horizontal force to the wedge. Assuming the coefficient of friction between all the surfaces in contact to be 0.3, determine the minimum horizontal force required to raise the block.

Solution:

Data Given:

Weight of block (W) = 1500 N

Angle of the wedge (α) = 10°

Coefficient of friction at all contact surfaces (μ) = 0.3

Let P = minimum horizontal force required to raise the load

The body DEFG is in equilibrium by the forces:
W=1500N, reaction R_1 at DE and reaction R_2 at DG

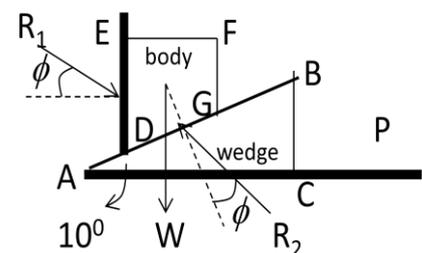

$$\mu = \tan\phi = 0.3 \quad \Rightarrow \quad \phi = \tan^{-1}(0.3) = 16.7^\circ$$

$$\text{Resolving the forces horizontally: } R_1 \cos(16.7^\circ) = R_2 \sin(10^\circ + 16.7^\circ) = R_2 \sin(26.7^\circ)$$

$$\Rightarrow R_1 \times 0.9578 = R_2 \times 0.4493 \quad \Rightarrow R_2 = 2.132 R_1$$

Resolving the forces vertically:

$$R_1 \sin(16.7^\circ) + 1500 = R_2 \cos(10^\circ + 16.7^\circ) = R_2 \cos(26.7^\circ)$$

$$\begin{aligned} \Rightarrow R_1 \times 0.2874 + 1500 &= R_2 \times 0.0.8934 \\ \Rightarrow R_1 \times 0.2874 + 1500 &= (2.132 R_1) \times 0.0.8934 = 1.905 R_1 \\ \Rightarrow R_1 \times (1.905 - 0.2874) &= 1500 \\ \therefore R_1 &= \frac{1500}{1.6176} = 927.3 \text{ N} \\ \text{and } R_2 &= 2.132 \times R_1 = 2.132 \times 927.3 = 1977 \text{ N} \end{aligned}$$

Consider the equilibrium of the wedge. The free body diagram is shown in figure.

The wedge is in equilibrium by the forces: reaction R_2 of the block on the wedge, force P acting horizontally and reaction R_3 on the face AC .

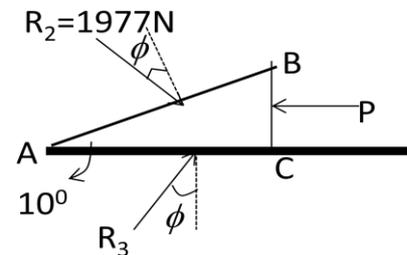

Resolving the forces vertically: $R_3 \cos 16.7^\circ = R_2 \cos (10^\circ + 16.7^\circ) = R_2 \cos 26.7^\circ$

$$\Rightarrow R_3 \times 0.9578 = R_2 \times 0.8934 = 1977 \times 0.8934 = 1766.2$$

$$\Rightarrow R_3 = \frac{1766.2}{0.9578} = 1844 \text{ N}$$

Resolving the forces horizontally:

$$\begin{aligned} P &= R_2 \sin (10^\circ + 16.7^\circ) + R_3 \sin 16.7^\circ = 1977 \sin (26.7^\circ) + 1844 \sin 16.7^\circ \\ \Rightarrow P &= (1977 \times 0.4493) + (1844 \times 0.2874) = 1418.3 \text{ N} \end{aligned} \quad (\text{Ans})$$

EXERCISE

- Que-1)** A uniform ladder of length 6m and weighing 100 N is kept against a smooth vertical wall with its lower end 5m away from the wall. If the ladder is about to slip, find (i) the coefficient of friction between the ladder and the floor, (ii) the frictional force acting on the ladder at the point of contact between the ladder and the floor.
- Que-2)** A uniform ladder of 4m length rests against a vertical wall with which it makes an angle of 45° . If the coefficient of friction between the ladder and the wall is 0.4 and that between the ladder and the floor is 0.5. If a man, whose weight is one-half of that of ladder, ascends it, how high will it be when the ladder slips?
- Que-3)** A ladder of length 4 m weighing 200 N is placed against a vertical wall and makes an angle of 60° with horizontal floor. The coefficient of friction between the wall and the ladder is 0.2 and that between the floor and the ladder is 0.3. The ladder also supports a man weighing 600 N at a distance 3 m from bottom of ladder. Calculate the minimum horizontal force to be applied at the bottom of ladder to prevent slipping.

CENTRE OF GRAVITY & MOMENT OF INERTIA

(Chapter 3)

Centroid:

Centroid of an area is that point at which the total area of the body is assumed to act.

Centre of Gravity:

Centre of gravity of a body is that point at which the total weight of the body is assumed to act.

Centroid of geometrical figures:

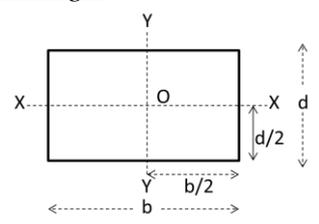
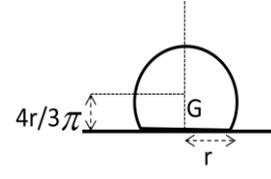
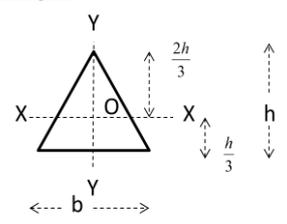
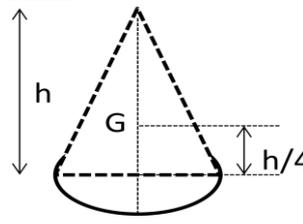
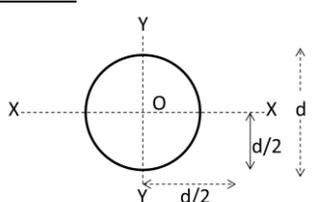
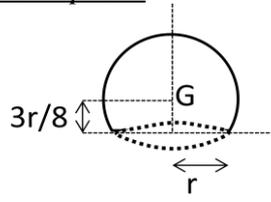
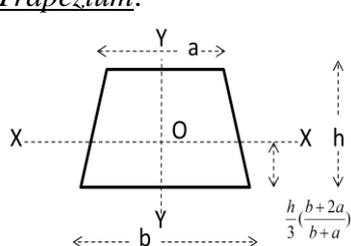
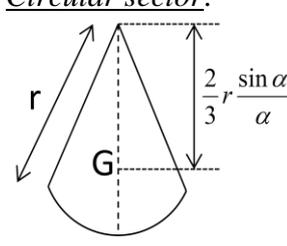
Sl.No.	Geometrical figure	Centroid at O	Sl.No.	Geometrical figure	Centroid at O
1	<p><u>Rectangle:</u></p> 	$\bar{X} = b/2$ $\bar{Y} = d/2$	5	<p><u>Semicircle:</u></p> 	$\bar{X} = d/2$ $\bar{Y} = (4r/3\pi)$ from base
2	<p><u>Triangle:</u></p> 	$\bar{X} = b/2$ $\bar{Y} = h/3$ (from base) $2h/3$ (from apex)	6	<p><u>Cone:</u></p> 	$\bar{X} = d/2$ $\bar{Y} = h/4$ from the base
3	<p><u>Circle:</u></p> 	$\bar{X} = d/2$ $\bar{Y} = d/2$	7	<p><u>Hemisphere:</u></p> 	Centroid 'G' is at a distance (3r/8) from its base
4	<p><u>Trapezium:</u></p> 	$\bar{X} = b/2$ $\bar{Y} = \frac{h}{3} \left(\frac{b+2a}{b+a} \right)$ from base	8	<p><u>Circular sector:</u></p> 	Centroid 'G' is at a distance $\left(\frac{2}{3} r \frac{\sin \alpha}{\alpha} \right)$ from the centre

Axis of reference:

These are the reference axis about which the location of Centre of gravity is calculated. For plane figures the lowest line is considered as reference axis to determine 'ȳ' and the left line is considered as the reference axis to determine 'x̄'.

Centroid of a rectangular lamina:

Consider a rectangular lamina of width 'b' and depth 'd' as shown in figure.

Let w = weight per unit area

\bar{x} = distance of C.G of area from Y-axis

\bar{y} = distance of C.G of area from X-axis

Area of rectangle = $b \times d$

Consider an elementary strip of small thickness 'dy' at a distance 'y' from the base (X-axis) as shown in figure.

Area of the strip = $b \times dy$

Moment of this area about X-axis = $b \times dy \times y$

The algebraic sum of the moments of all such elementary area about X-axis = $\int_0^d (b \times y \times dy)$

Moment of total area W about X-axis = $b \times d \times \bar{y}$

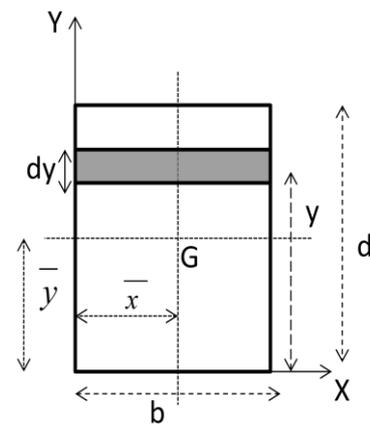

According to law of moments:

$$b \times d \times \bar{y} = \int_0^d (b \times y \times dy)$$

$$\Rightarrow b \times d \times \bar{y} = b \times \int_0^d (y \times dy)$$

$$\Rightarrow d \times \bar{y} = \int_0^d (y \times dy) = \left[\frac{y^2}{2} \right]_0^d = \frac{d^2}{2}$$

$$\Rightarrow \bar{y} = \frac{d}{2}$$

Similarly we can get: $\bar{x} = \frac{b}{2}$

\therefore centroid of rectangular lamina is

$$\left(\frac{b}{2}, \frac{d}{2} \right)$$

Centroid of a square lamina:

Centroid of a square lamina can be obtained similar to Centroid of rectangular lamina.

If the sides of a square lamina is 'a', then its Centroid is given by $\left(\frac{a}{2}, \frac{a}{2} \right)$

Centroid of a circular lamina:

Consider a circular lamina of centre 'O' and radius 'R' as shown in figure.

Consider any point P and Q on its circumference such that $\angle XOP = \theta$ & $\angle POQ = d\theta$

Assume P and Q are closer and PQ is a straight line such that OPQ may be a triangle.

Let G_1 is the C.G of elementary strip OPQ.

$$OG_1 = \frac{2}{3} OP = \frac{2}{3} R$$

$$\text{Perpendicular distance of the point } G_1 \text{ from the axis } X^1OX = \frac{2}{3} R \sin \theta$$

$$\text{Perpendicular distance of the point } G_1 \text{ from the axis } Y^1OY = \frac{2}{3} R \cos \theta$$

$$\text{Area of elementary strip OPQ} = \frac{1}{2} \times OP \times OQ = \frac{1}{2} \times R \times R \cdot d\theta = \frac{1}{2} \times R^2 \cdot d\theta$$

$$\text{Moment of this area about axis } Y^1OY = \frac{1}{2} \times R^2 \cdot d\theta \times \frac{2}{3} R \cos \theta = \frac{1}{3} \times R^3 \cdot \cos \theta \cdot d\theta$$

The algebraic sum of the moments of all such elementary area about axis Y^1OY

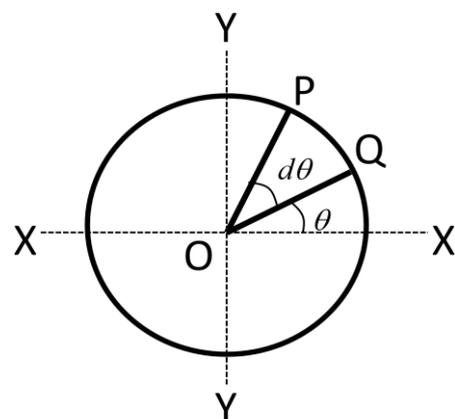

$$= \int_0^{2\pi} \left(\frac{1}{3} \times R^3 \cdot \cos \theta \cdot d\theta \right) = \frac{1}{3} \times R^3 \cdot \int_0^{2\pi} (\cos \theta \cdot d\theta) \text{ ---- (1)}$$

Total area of the circular lamina = πR^2

Let G be the C.G of the circular lamina which is at a distance \bar{x} and \bar{y} from Y^1OY and X^1OX axis respectively.

Moment of total area about Y^1OY axis = $\pi R^2 \times \bar{x}$ ----- (2)

Equating 1 and 2 we get: $\pi R^2 \times \bar{x} = \frac{1}{3} \times R^3 \cdot \int_0^{2\pi} (\cos \theta \cdot d\theta)$

$$\Rightarrow \pi \cdot \bar{x} = \frac{1}{3} \times R \int_0^{2\pi} (\cos \theta \cdot d\theta) = \frac{1}{3} \times R \times [\sin \theta]_0^{2\pi}$$

$$\Rightarrow \bar{x} = \frac{R}{3\pi} (\sin 2\pi - 0) = 0$$

Similarly: $\bar{y} = 0$

\therefore The centroid of circular lamina lies at its centre.

Centroid of a triangular lamina:

Consider a triangular lamina ABC of base 'b' and height 'h'. Consider an elementary strip of very small thickness 'dy' parallel to its base at a distance 'y' from its base BC.

Let b_1 = width of the elementary strip
 w = weight per unit area of the lamina
 dA = area of the elementary strip = $b_1 \times dy$

From the two similar triangles ADE and ABC we get:

$$\frac{b_1}{b} = \frac{h-y}{h} \Rightarrow b_1 = \frac{b(h-y)}{h}$$

area of elementary strip = $\frac{b(h-y)}{h} \times dy$

Moment of elementary area about base BC

$$= \frac{b(h-y)}{h} \times dy \times y$$

Algebraic sum of the moments of all such elementary area about base BC = $\int_0^h \left(\frac{b(h-y)}{h} \times dy \times y \right)$ ----- (1)

Area of the triangle ABC = $\frac{1}{2} bh$

Moment of area about base BC = $\frac{1}{2} bh \times \bar{y}$ --- (2)

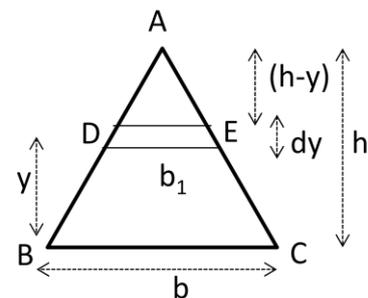

Equating 1 & 2 we get;

$$\frac{1}{2} bh \times \bar{y} = \int_0^h \left(\frac{b(h-y)}{h} \times dy \times y \right)$$

$$= \int_0^h (by - \frac{by^2}{h}) \times dy$$

$$\Rightarrow \frac{1}{2} bh \times \bar{y} = b \int_0^h \left(y - \frac{y^2}{h} \right) \times dy$$

$$\Rightarrow \frac{1}{2} h \times \bar{y} = \int_0^h y \cdot dy - \int_0^h \frac{y^2}{h} \times dy$$

$$= \left[\frac{y^2}{2} \right]_0^h - \frac{1}{h} \times \left[\frac{y^3}{3} \right]_0^h$$

$$= \frac{h^2}{2} - \frac{h^3}{3} = \frac{h^2}{6}$$

$$\Rightarrow \frac{1}{2} h \times \bar{y} = \frac{h^2}{6} \Rightarrow \bar{y} = \frac{h}{3}$$

\therefore Centroid of triangular lamina is $\frac{h}{3}$ from its base and $\frac{2h}{3}$ from its apex.

Centroid of a semicircular lamina:

Consider a semicircular lamina of radius 'r' as shown in figure.

Consider the elementary area OPQ such that $\angle POQ = d\theta$ and $\angle BOP = \theta$

Area of OPQ = $\frac{1}{2} r^2 d\theta$

Distance of centroid of the elementary area is $\frac{2}{3} r$ from 'O'. Height of centroid of the elementary area above AB = $\frac{2}{3} r \sin \theta$

Moment of the elementary area about AB = $\frac{1}{2} r^2 d\theta \times \frac{2}{3} r \sin \theta = \frac{1}{3} r^3 \sin \theta d\theta$

Moment of whole area about AB = $\int_0^\pi (\frac{1}{3} r^3 \sin \theta \cdot d\theta) = \frac{1}{3} r^3 \int_0^\pi (\sin \theta \cdot d\theta)$
 $= \frac{1}{3} r^3 [-\cos \theta]_0^\pi = \frac{1}{3} r^3 [-\cos \pi + \cos 0]$
 $= \frac{2}{3} r^3$ ----- (1)

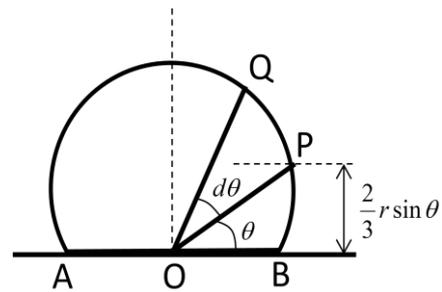

Let \bar{y} = height of centroid above AB

Area of the semicircle = $\frac{\pi r^2}{2}$

Moment about AB = $\frac{\pi r^2}{2} \times \bar{y}$ ----- (2)

From 1 and 2 we get:

$\Rightarrow \frac{\pi r^2}{2} \times \bar{y} = \frac{2}{3} r^3 \Rightarrow \bar{y} = \frac{4r}{3\pi}$

∴ The centroid of the semicircular lamina is at a distance $\frac{4r}{3\pi}$ from its base taken on Y-Y axis.

SOLVED PROBLEM

Centroid of Composite Section

Problem-1: Find the centroid of a 100 mm × 150 mm × 30 mm T-section.

Solution:

This section is symmetrical about Y-Y axis, so the C.G of this section will lie on this axis.

Consider ABCH and DEFG as two rectangles and FE as the reference axis.

Rectangle ABCH:

Area (a₁) = 100 × 30 = 3000 mm²

Distance of C.G of this rectangle from FE = y₁ = 135 mm

Rectangle DEFG:

Area (a₂) = 120 × 30 = 3600 mm²

Distance of C.G of this rectangle from FE = y₂ = 60 mm

∴ distance of C.G of the section from FE =

$\bar{y} = \frac{a_1 y_1 + a_2 y_2}{a_1 + a_2} = \frac{(3000 \times 135) + (3600 \times 60)}{3000 + 3600} = 94.1 \text{ mm}$

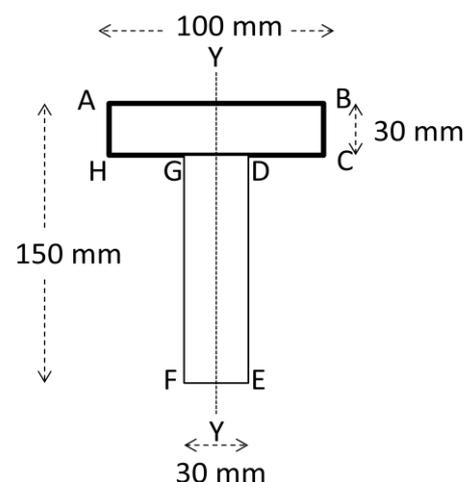

(ANS)

Problem-2: Find the centroid of a channel section 100 mm × 50 mm × 15 mm.

Solution:

This section is symmetrical about X-X axis, so the C.G of this section will lie on this axis.

Consider ABFJ, EGKJ and CDHK as three rectangles and AC as the reference axis.

Rectangle ABFJ:

$$\text{Area } (a_1) = 50 \times 15 = 750 \text{ mm}^2$$

$$\text{Distance of C.G of this rectangle from AC} = y_1 = 25 \text{ mm}$$

Rectangle EGKJ:

$$\text{Area } (a_2) = 70 \times 15 = 1050 \text{ mm}^2$$

$$\text{Distance of C.G of this rectangle from AC} = y_2 = 7.5 \text{ mm}$$

Rectangle CDHK:

$$\text{Area } (a_2) = 50 \times 15 = 750 \text{ mm}^2$$

$$\text{Distance of C.G of this rectangle from AC} = y_3 = 25 \text{ mm}$$

∴ distance of C.G of the section from AC =

$$\begin{aligned} \bar{x} &= \frac{a_1x_1 + a_2x_2 + a_3x_3}{a_1 + a_2 + a_3} \\ &= \frac{(750 \times 25) + (1050 \times 7.5) + (750 \times 25)}{750 + 1050 + 750} = 17.8 \text{ mm} \end{aligned}$$

(ANS)

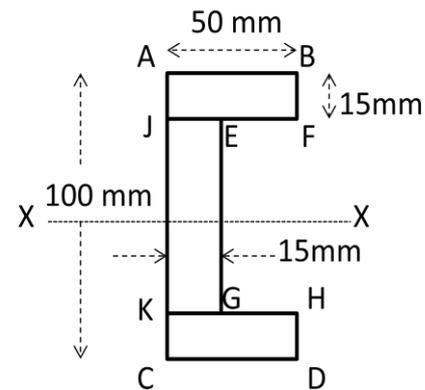

Problem-3: An I-section has the following dimensions in mm:

Bottom flange = 300 × 100; Top flange = 150 × 50; Web = 300 × 50

Determine the position of C.G of the I-section.

Solution:

This section is symmetrical about Y-Y axis, so the C.G of this section will lie on this axis.

Consider the bottom flange, web and the top flange as three rectangles and bottom of the bottom flange AB as the reference axis.

Bottom flange:

$$\text{Area } (a_1) = 300 \times 100 = 30000 \text{ mm}^2$$

$$\text{Distance of C.G of this rectangle from AB} = y_1 = 50 \text{ mm}$$

Web:

$$\text{Area } (a_2) = 300 \times 50 = 15000 \text{ mm}^2$$

$$\text{Distance of C.G of this rectangle from AB} = y_2 = 250 \text{ mm}$$

Top flange:

$$\text{Area } (a_2) = 150 \times 50 = 7500 \text{ mm}^2$$

$$\text{Distance of C.G of this rectangle from AB} = y_3 = 425 \text{ mm}$$

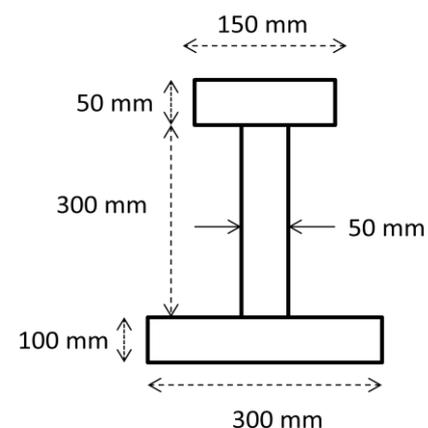

∴ distance of C.G of the section from AB =

$$\begin{aligned}\bar{y} &= \frac{a_1 y_1 + a_2 y_2 + a_3 y_3}{a_1 + a_2 + a_3} \\ &= \frac{(30000 \times 50) + (15000 \times 250) + (7500 \times 425)}{30000 + 15000 + 7500} \\ &= 160.7 \text{ mm} \quad (\text{ANS})\end{aligned}$$

Problem-4: Find the centroid of an unequal angle section 100 mm × 80 mm × 20 mm.

Solution:

This section is not symmetrical about any axis. So we have to determine both \bar{x} and \bar{y} on considering two reference axis AB and BC respectively. This L-section may be split into two rectangles as rectangle-1 and rectangle-2.

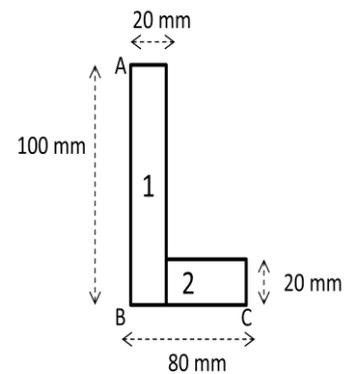

Rectangle-1:

$$\text{Area } (A_1) = 100 \times 20 = 2000 \text{ mm}^2$$

$$\text{Distance of C.G of this rectangle from AB } (x_1) = 10 \text{ mm}$$

$$\text{Distance of C.G of this rectangle from BC } (y_2) = 50 \text{ mm}$$

Rectangle-2:

$$\text{Area } (A_2) = 60 \times 20 = 1200 \text{ mm}^2$$

$$\text{Distance of C.G of this rectangle from AB } (x_2) = 50 \text{ mm}$$

$$\text{Distance of C.G of this rectangle from BC } (y_2) = 10 \text{ mm}$$

$$\begin{aligned}\therefore \text{ distance of C.G of the section from AB} &= \bar{x} = \frac{a_1 x_1 + a_2 x_2}{a_1 + a_2} \\ &= \frac{(2000 \times 10) + (1200 \times 50)}{2000 + 1200} = 25 \text{ mm}\end{aligned}$$

$$\begin{aligned}\therefore \text{ distance of C.G of the section from BC} &= \bar{y} = \frac{a_1 y_1 + a_2 y_2}{a_1 + a_2} \\ &= \frac{(2000 \times 50) + (1200 \times 10)}{2000 + 1200} = 35 \text{ mm} \quad (\text{ANS})\end{aligned}$$

MOMENT OF INERTIA:

Moment of inertia of a plane area is the moment of first moment of area. It is known as second moment of inertia.

M.I of plane lamina:

Consider a plane lamina whose moment of inertia is required about X-X axis and Y-Y axis.

Consider a strip in the plane figure as shown in figure.

Let: dA = area of the strip

x = distance of C.G of the strip on X-X axis

y = distance of C.G of the strip on Y-Y axis

M.I of the strip about Y-Y axis = $dA \cdot x^2$

M.I of the whole area can be obtained by integrating the above expression. We may get:

$$I_{YY} = \sum dA \cdot x^2 \quad \text{and} \quad I_{XX} = \sum dA \cdot y^2$$

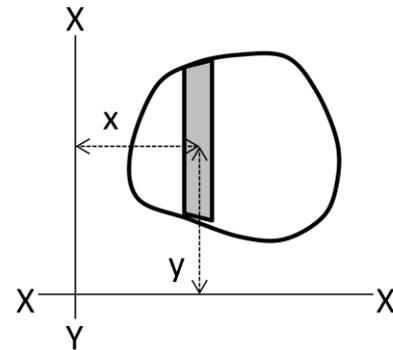

Perpendicular axis theorem:

It states that, ‘the sum of moment of inertia of an area about two mutually perpendicular and co-planar axes is equal to the moment of inertia of the area about an axis which is perpendicular to both the above axes’.

Proof:

Consider a small lamina P of area ‘da’ at a distance ‘x’ from OY – axis and ‘y’ from OX-axis as shown in figure. OX and OY are the two mutually perpendicular axes.

Let, OZ axis is perpendicular to OX and OY and ‘r’ is the distance of the lamina from this axis.

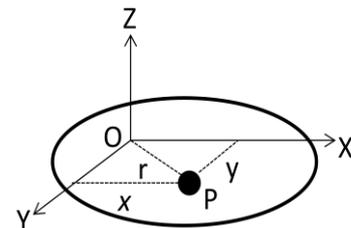

From geometry: $r^2 = x^2 + y^2$ ----- (1)

Moment of inertia of the lamina P about X-X axis =

Moment of inertia of the lamina P about Y-Y axis =

$$I_{YY} = da \cdot x^2$$

Moment of inertia of the lamina P about Z-Z axis =

$$I_{ZZ} = da \cdot r^2$$

From equation-1 we get:

$$r^2 = x^2 + y^2 \Rightarrow da \cdot r^2 = da \cdot x^2 + da \cdot y^2$$

$$\therefore \boxed{I_{ZZ} = I_{XX} + I_{YY}}$$

$$I_{XX} = da \cdot y^2$$

$$I_{YY} = da \cdot x^2$$

Parallel axis theorem:

It states that, ‘the moment of inertia of an area about a non-centroidal axis is equal to the moment of inertia of the area about its centroidal axis which is parallel to the non-centroidal axis plus the product of the magnitude of the area and the square of the distance of the C.G of the area from the given axis’.

Proof:

Consider a strip of circle, whose moment of inertia is required about a line AB as shown in figure.
Line AB is parallel to the axis passing through the C.G of the circle.

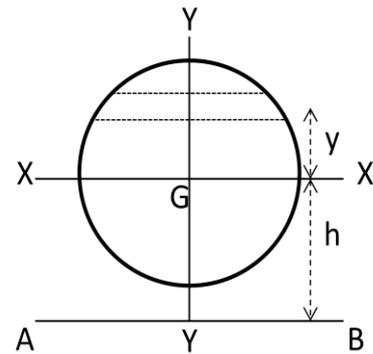

Let, δa = area of the small strip
 y = distance of strip from the centre of gravity
 h = distance between centre of gravity of the section
 and the axis AB

Moment of inertia of the whole section about the axis X-X passing through the C.G of the section $(I_G) = \sum \delta a \cdot y^2$

Moment of inertia of the section about the axis AB

$$I_{AB} = \sum \delta a \cdot (h + y)^2 = \sum \delta a (h^2 + y^2 + 2hy)$$

$$= \sum h^2 \delta a + \sum y^2 \delta a + \sum 2hy \cdot \delta a$$

$$= ah^2 + I_G + 0 = I_G + ah^2$$

M.I of rectangular section:

Consider a rectangular section ABCD of width 'b' and depth 'd' as shown in figure.

Consider a strip PQ of thickness 'dy' at a distance 'y' from the X-X axis.

Area of the strip = b.dy

Moment of inertia of the strip about X-X axis = area \times y^2

$$= (b \cdot dy) \times y^2 = b \cdot y^2 \cdot dy$$

M.I of the whole section can be obtained by integrating the above expression from $-\frac{d}{2}$ to $+\frac{d}{2}$

$$I_{xx} = \int_{-\frac{d}{2}}^{+\frac{d}{2}} b \cdot y^2 \cdot dy = b \times \int_{-\frac{d}{2}}^{+\frac{d}{2}} y^2 \cdot dy = b \times \left[\frac{y^3}{3} \right]_{-\frac{d}{2}}^{+\frac{d}{2}}$$

$$= b \times \left[\frac{\left(\frac{d}{2}\right)^3}{3} - \frac{\left(-\frac{d}{2}\right)^3}{3} \right] = \frac{bd^3}{12}$$

Similarly: $I_{yy} = \frac{db^3}{12}$

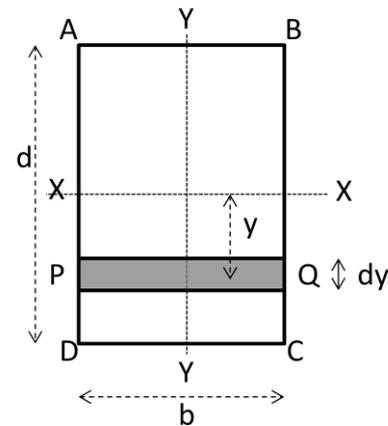

M.I of hollow rectangular section:

Consider a hollow rectangular section ABCD as the main section and EFGH as the cut out section as shown in figure.

- Let: b = breadth of outer rectangle
- d = depth of outer rectangle
- b_1 = breadth of cut out rectangle
- d_1 = depth of cut out rectangle

M.I of the outer rectangle ABCD about X-X axis = $\frac{bd^3}{12}$

M.I of the cut out rectangle EFGH about X-X axis = $\frac{b_1d_1^3}{12}$

∴ M.I of hollow rectangular section about X-X axis =

$$\frac{bd^3}{12} - \frac{b_1d_1^3}{12}$$

∴ M.I of hollow rectangular section about Y-Y axis = $\frac{db^3}{12} - \frac{d_1b_1^3}{12}$

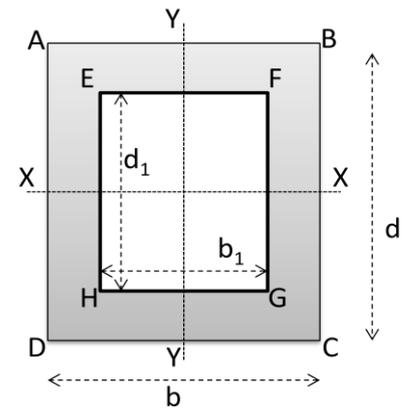

M.I of circular section:

Consider a circle ABCD of radius 'r' with centre 'o'. X-X and Y-Y are the two axis of reference.

Consider a elementary ring of radius 'x' and thickness 'dx' as shown in figure.

Area of the ring (da) = $2\pi x \cdot dx$

M.I of the ring about X-X axis or Y-Y axis = area × (distance)² = $2\pi x \cdot dx \times x^2 = 2\pi x^3 \cdot dx$

M.I of the whole section can be obtained by integrating the above expression from zero to 'r'

$$I_{ZZ} = \int_0^r 2\pi x^3 \cdot dx = 2\pi \int_0^r x^3 \cdot dx = 2\pi \left[\frac{x^4}{4} \right]_0^r = \frac{\pi}{2} \times r^4 = \frac{\pi}{32} d^4$$

According to perpendicular axis theorem $I_{ZZ} = I_{XX} + I_{YY}$

∴ $I_{XX} = I_{YY} = \frac{I_{ZZ}}{2} = \frac{1}{2} \times \frac{\pi}{32} d^4 = \frac{\pi}{64} d^4 = \frac{\pi}{4} r^4$

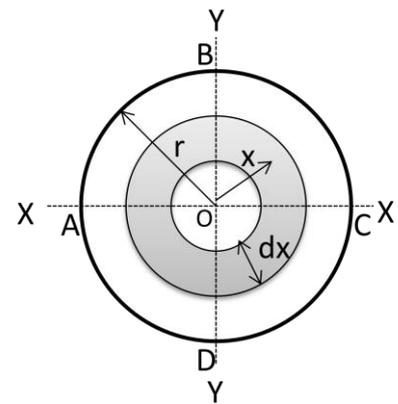

M.I of hollow circular section:

Consider a hollow circular section as shown in figure.

- Let: D = diameter of the main circle
- d = diameter of the cut out circle

M.I of the main circle about X-X axis = $\frac{\pi}{64} D^4$

M.I of the cut out circle about X-X axis = $\frac{\pi}{64} d^4$

M.I of the hollow circular section about X-X or Y-Y

axis (I_{XX}) or (I_{YY}) = $\frac{\pi}{64} D^4 - \frac{\pi}{64} d^4 = \frac{\pi}{64} (D^4 - d^4)$

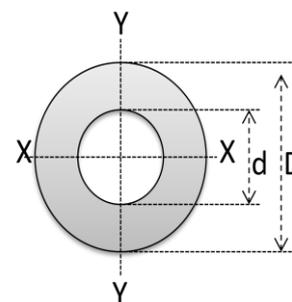

M.I of semicircular section:

Consider a semicircular section ABC of radius ‘r’ and centre ‘O’ as shown in figure.

M.I of the semicircular section about the base AC is equal to half of the M.I of the circular section.

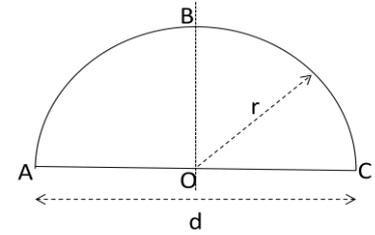

M.I of the section AC = $I_{AC} =$

$$\frac{1}{2} \times \frac{\pi}{64} \times d^4 = \frac{\pi}{128} \times d^4 = \frac{\pi}{8} r^4 = 0.393r^4$$

Area of the semicircular section (a) = $\frac{\pi r^2}{2}$

Distance between C.G of the section and the base AC (h) = $\frac{4r}{3\pi}$

M.I of the section about X-X axis passing through its C.G

$$= I_G = I_{AC} - ah^2 = \left[\frac{\pi}{8} r^4 \right] - \left[\frac{\pi r^2}{2} \left(\frac{4r}{3\pi} \right)^2 \right]$$

$$= \left[\frac{\pi}{8} r^4 \right] - \left[\frac{8}{9\pi} \times r^4 \right] = 0.11r^4$$

M.I of triangular section:

Consider a triangular section ABC of base ‘b’ and height ‘h’ as shown in figure.

Consider a small strip PQ of thickness ‘dx’ at a distance ‘x’ from A.

From geometry: APQ and ABC are two similar triangles.

$$\frac{PQ}{BC} = \frac{x}{h} \Rightarrow PQ = \frac{BC \times x}{h} = \frac{bx}{h}$$

Area of the strip PQ = $\frac{bx}{h} \times dx$

M.I of the strip about the base BC = area × (distance)²

$$= \frac{bx}{h} \times dx (h-x)^2 = \frac{bx}{h} (h-x)^2 dx$$

M.I of the whole section can be obtained by integrating the above expression from zero to ‘h’.

$$I_{BC} = \int_0^h \frac{bx}{h} (h-x)^2 dx = \frac{b}{h} \int_0^h x(h^2 + x^2 - 2hx)$$

$$= \frac{b}{h} \int_0^h (xh^2 + x^3 - 2hx^2) dx =$$

$$\frac{b}{h} \left[\frac{x^2 h^2}{2} + \frac{x^4}{4} - \frac{2hx^3}{3} \right]_0^h = \frac{bh^3}{12}$$

This is the expression for M.I of triangular section about its base.

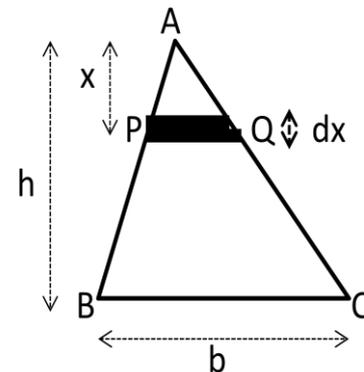

Distance of C.G of the section from the base BC = (d/2)

M.I of the triangular section about an axis through its C.G (X-X axis) = $I_G = I_{BC} - ad^2$

$$= \frac{bh^3}{12} - \left(\frac{bh}{2} \right) \left(\frac{h}{3} \right)^2 = \frac{bh^3}{36}$$

SOLVED PROBLEM

Moment of Inertia of Composite Section

Problem-1: Find the M.I of a T-section with flange as 150 mm × 50 mm and web as 150 mm × 50 mm about X-X axis and Y-Y axis through the centre of gravity of the section.

Solution:

C.G of the section:

This section is symmetrical about Y-Y axis, so the C.G of this section will lie on this axis. Consider rectangle-1 and 2 as shown in figure.

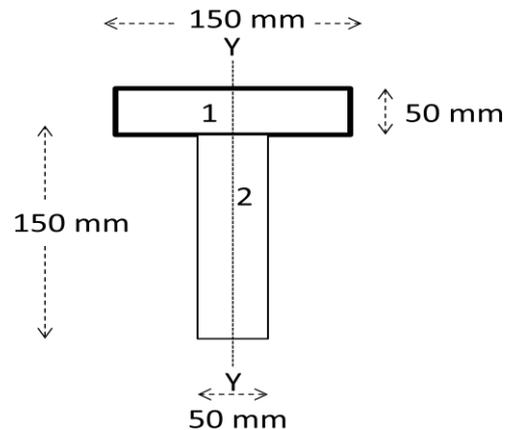

Rectangle -1:

$$\text{Area } (a_1) = 150 \times 50 = 7500 \text{ mm}^2$$

$$y_1 = 175 \text{ mm}$$

Rectangle -2:

$$\text{Area } (a_2) = 150 \times 50 = 7500 \text{ mm}^2$$

$$y_2 = 60 \text{ mm}$$

∴ distance of C.G of the section from bottom of the Web =

$$\bar{y} = \frac{a_1 y_1 + a_2 y_2}{a_1 + a_2} = \frac{(7500 \times 175) + (7500 \times 75)}{7500 + 7500} = 125 \text{ mm}$$

M.I about X-X axis:

M.I of rectangle-1 about an axis passing through its C.G and parallel to X-X axis = I_{G1}

$$= \frac{150 \times 50^3}{12} = 1.5625 \times 10^6 \text{ mm}^4$$

Distance between C.G of rectangle-1 from X-X axis = $h_1 = 175 - 125 = 50 \text{ mm}$

M.I of rectangle-1 about X-X axis =

$$I_{G1} + a_1 h_1^2 = (1.5625 \times 10^6) + (7500 \times 50^2) = 20.3125 \times 10^6 \text{ mm}^4 \text{ ----- (1)}$$

M.I of rectangle-2 about an axis passing through its C.G and parallel to X-X axis = I_{G2}

$$= \frac{50 \times 150^3}{12} = 14.0625 \times 10^6 \text{ mm}^4$$

Distance between C.G of rectangle-2 from X-X axis = $h_2 = 125 - 75 = 50 \text{ mm}$

M.I of rectangle-2 about X-X axis =

$$I_{G2} + a_2 h_2^2 = (14.0625 \times 10^6) + (7500 \times 50^2) = 32.8125 \times 10^6 \text{ mm}^4 \text{ ----- (2)}$$

∴ M.I of the whole section about X-X axis = $(20.3125 \times 10^6) + (32.8125 \times 10^6)$

$$= 53.125 \times 10^6 \text{ mm}^4. \quad (\text{ANS})$$

M.I about Y-Y axis:

$$\text{M.I of rectangle-1 about Y-Y axis} = \frac{50 \times 150^3}{12} = 14.0625 \times 10^6 \text{ mm}^4$$

$$\text{M.I of rectangle-2 about Y-Y axis} = \frac{150 \times 50^3}{12} = 1.5625 \times 10^6 \text{ mm}^4$$

$$\begin{aligned} \therefore \text{ M.I of the whole section about Y-Y axis} &= (14.0625 \times 10^6) + (1.5625 \times 10^6) \\ &= 15.625 \times 10^6 \text{ mm}^4. \quad (\text{ANS}) \end{aligned}$$

Problem-2: Find the M.I of the I-section about the horizontal and vertical axis passing through its centre of gravity. The dimension of the top flange is 60 mm × 20 mm, web is 100 mm × 20 mm and bottom flange is 100 mm × 20 mm.

Solution:

C.G of the section:

This section is symmetrical about Y-Y axis, so the C.G of this section will lie on this axis. Consider rectangle-1, 2 and 3 as shown in figure.

Rectangle -1:

$$\begin{aligned} \text{Area } (a_1) &= 60 \times 20 = 1200 \text{ mm}^2 \\ y_1 &= 130 \text{ mm} \end{aligned}$$

Rectangle -2:

$$\begin{aligned} \text{Area } (a_2) &= 100 \times 20 = 2000 \text{ mm}^2 \\ y_2 &= 70 \text{ mm} \end{aligned}$$

Rectangle -3:

$$\begin{aligned} \text{Area } (a_3) &= 100 \times 20 = 2000 \text{ mm}^2 \\ y_3 &= 10 \text{ mm} \end{aligned}$$

\therefore distance of C.G of the section from bottom of the bottom flange =

$$\bar{y} = \frac{a_1 y_1 + a_2 y_2 + a_3 y_3}{a_1 + a_2 + a_3} = \frac{(1200 \times 130) + (2000 \times 70) + (2000 \times 10)}{1200 + 2000 + 2000} = 60.8 \text{ mm}$$

M.I about X-X axis:

M.I of rectangle-1 about an axis passing through its C.G and parallel to X-X axis = I_{G1}

$$= \frac{60 \times 20^3}{12} = 40 \times 10^3 \text{ mm}^4$$

Distance between C.G of rectangle-1 from X-X axis = $h_1 = 130 - 60.8 = 69.2 \text{ mm}$

M.I of rectangle-1 about X-X axis =

$$I_{G1} + a_1 h_1^2 = (40 \times 10^3) + (1200 \times (69.2)^2) = 5786 \times 10^3 \text{ mm}^4 \text{ ----- (1)}$$

M.I of rectangle-2 about an axis passing through its C.G and parallel to X-X axis = I_{G2}

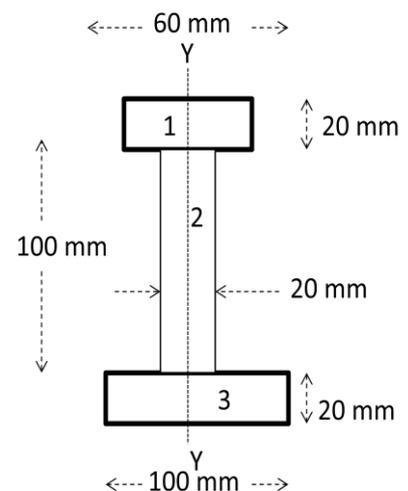

$$= \frac{20 \times 100^3}{12} = 1666.7 \times 10^3 \text{ mm}^4$$

Distance between C.G of rectangle-2 from X-X axis = $h_2 = 70 - 60.8 = 9.2 \text{ mm}$

M.I of rectangle-2 about X-X axis =

$$I_{G2} + a_2 h_2^2 = (1666.7 \times 10^3) + (2000 \times (9.2)^2) = 1836 \times 10^3 \text{ mm}^4 \text{ ----- (2)}$$

M.I of rectangle-3 about an axis passing through its C.G and parallel to X-X axis = I_{G3}

$$= \frac{100 \times 20^3}{12} = 66.7 \times 10^3 \text{ mm}^4$$

Distance between C.G of rectangle-3 from X-X axis = $h_3 = 60.8 - 10 = 50.8 \text{ mm}$

M.I of rectangle-3 about X-X axis =

$$I_{G3} + a_3 h_3^2 = (66.7 \times 10^3) + (2000 \times (50.8)^2) = 5228 \times 10^3 \text{ mm}^4 \text{ ----- (1)}$$

$$\begin{aligned} \therefore \text{M.I of the whole section about X-X axis} &= (5786 \times 10^3) + (1836 \times 10^3) + (5228 \times 10^3) \\ &= 12850 \times 10^3 \text{ mm}^4. \quad (\text{ANS}) \end{aligned}$$

M.I about Y-Y axis:

$$\text{M.I of rectangle-1 about Y-Y axis} = \frac{20 \times 60^3}{12} = 360 \times 10^3 \text{ mm}^4$$

$$\text{M.I of rectangle-2 about Y-Y axis} = \frac{100 \times 20^3}{12} = 66.67 \times 10^3 \text{ mm}^4$$

$$\text{M.I of rectangle-3 about Y-Y axis} = \frac{20 \times 100^3}{12} = 1666.67 \times 10^3 \text{ mm}^4$$

\therefore M.I of the whole section about Y-Y axis =

$$(360 \times 10^3) + (66.67 \times 10^3) + (1666.67 \times 10^3) = 17094.34 \times 10^3 \text{ mm}^4. \quad (\text{ANS})$$

EXERCISE

Q.1) Determine the centroid of the given section.

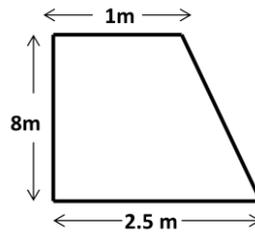

Q.2) Locate the centroid of the cut out section (Shaded area) as shown in the figure.

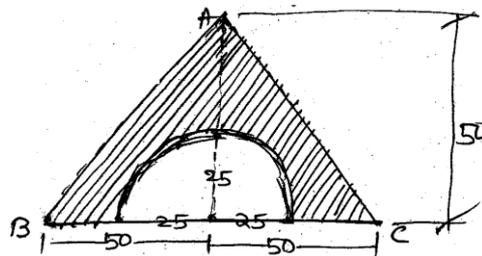

Q.3) An isosceles triangle of side 200 mm has been cut from a square of side 200 mm as per the figure given below. Find out the C.G of the shaded area.

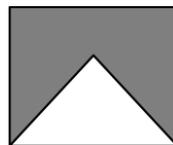

Q.4) An isosceles triangular section ABC has base width 80 mm and height 60 mm. Determine the moment of inertia of the section about the centre of gravity of the section and the base BC.

Q.5) Determine the M.I of a semicircular section of 100 mm diameter about its centre of gravity and parallel to X-X and Y-Y axes.

Q.6) Determine the M.I of the given section about the axis AB.

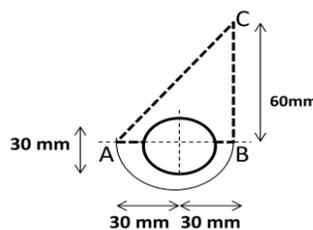

Q.7) Determine the M.I of the given section about centroidal axis.

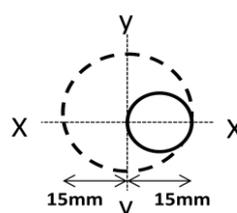

Q.8) Determine the least and greatest moment of inertia of an unequal angle section shown below.

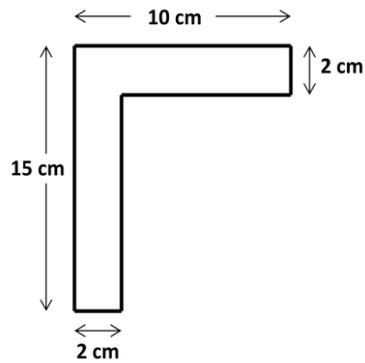

Q.9) A triangular section is cut from a quarter circular section as shown in figure. Find the position of centroid of cut out section.

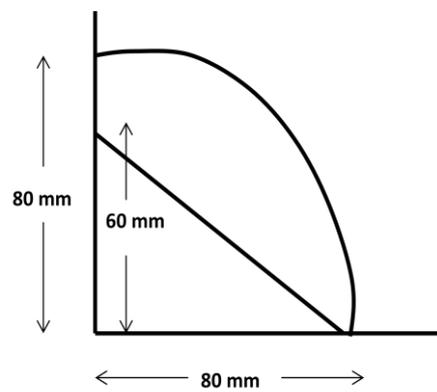

Q.10) Find the Moment of inertia of a square section of side 80 mm about its diagonal.

(End)

SIMPLE LIFTING MACHINE

(Chapter 4)

Lifting Machine:

A machine which is used to lift heavy loads comparatively by using smaller effort is known as lifting machine.

Simple lifting machines:

It is a device which is able to overcome resistance and produce useful work in terms of lifting or lowering load when effort is given to it.

Compound lifting machine:

It is a device which consists of a number of simple machines which is able to lift or lower load at a faster speed and lesser effort.

Concept of a simple lifting Machine:

Consider a simple pulley which is used to raise a load (W) by effort (P). When the effort P is applied at the end of rope the effort moves by distance 'y', while the load moves up by a distance 'x'.

Input of a Machine:

It is the work done on the machine to lift load. It is the product of effort (P) applied to lift the load and distance moved by the effort (y).

Output of a Machine:

It is the work done by the machine. It is the product of weight (W) lifted and the distance moved by the effort (x).

Efficiency of the machine:

It is the ratio of output work to input work of the machine.

$$\text{i.e. efficiency} = \frac{\text{output}}{\text{input}}$$

A simple pulley used to lift load W by an effort P.

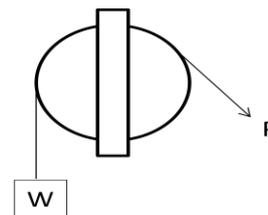

Mechanical advantage (M.A):

It is the ratio of weight lifted by the effort applied to lift the load.

$$\text{i.e. M.A} = \frac{W}{P}$$

Velocity ratio (V.R):

It is the ratio of distance moved by the effort (y) to the distance moved by the load (x).

$$\text{i.e. V.R} = \frac{y}{x}$$

Expression for efficiency of simple lifting machine:

Consider a lifting machine which lifts weight W by a smaller effort P.

Let y = distance moved by effort x = distance moved by effort

$$\text{We know that, } \text{M.A} = \frac{W}{P} \quad \text{and} \quad \text{V.R} = \frac{y}{x}$$

$$\text{Input of the machine} = P \times y \quad \text{Output of the machine} = \frac{W \times x}{P}$$

$$\text{We know that efficiency of the machine } (\eta) = \frac{\text{output}}{\text{input}} = \frac{W \cdot x}{P \cdot y} = \frac{\frac{W}{P} \cdot x}{\frac{y}{x}} = \frac{\text{MA}}{\text{VR}}$$

This is the required expression for efficiency of the machine.

Condition of self locking:

A machine is called as self locking, if it is unable to do work in reverse direction after the removal of load from it.

For a actual machine, friction loss in machine = input – output = $(P \times y) - (W \times x)$

For a self locking machine output of the machine is less than or equal to the frictional loss.

$$\begin{aligned} \text{When effort } P \text{ is zero, we can write: } & W \times x \leq (P \times y) - (W \times x) \\ \Rightarrow & 2 \times (W \times x) \leq (P \times y) \\ \Rightarrow & \frac{W \times x}{P \times y} \leq \frac{1}{2} \\ \Rightarrow & \frac{MA}{VR} \leq \frac{1}{2} \\ \Rightarrow & \eta \leq \frac{1}{2} \text{ or } 50\% \end{aligned}$$

∴ Thus for a self locking machine efficiency is less than or equal to 50%.

Condition of reversibility:

A machine is called as reversible, if it is able to do work in reverse direction after the removal of load from it.

For a actual machine, friction loss in machine = input – output = $(P \times y) - (W \times x)$

For a reversible machine output of the machine is more than frictional loss.

$$\begin{aligned} \text{When effort } P \text{ is zero, we can write: } & W \times x > (P \times y) - (W \times x) \\ \Rightarrow & 2 \times (W \times x) > (P \times y) \\ \Rightarrow & \frac{W \times x}{P \times y} > \frac{1}{2} \\ \Rightarrow & \frac{MA}{VR} > \frac{1}{2} \\ \Rightarrow & \eta > \frac{1}{2} \text{ or } 50\% \end{aligned}$$

∴ Thus, for a reversible machine efficiency is greater than 50%.

Law of Machine:

The law of machine gives the relation between the load to be lifted and effort required.

If a machine lift loads corresponding to applied efforts, then a relation is obtained which can be shown graphically as shown in figure.

The straight line AB shown in figure represents the law of machine.

i.e. $P = mW + C$

Maximum M.A = $\frac{1}{m}$

Maximum Efficiency = $\frac{1}{m \times V.R}$

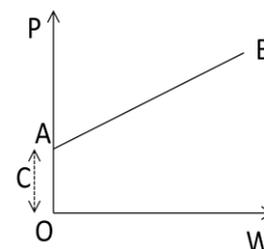

P = effort applied to lift the load

W = load lifted

m = a constant = slope of the line AB

C = a constant = machine friction = OA

Effect of friction in simple lifting machines:

In actual machines there is friction at the effort side or load side. Due to this extra work is needed to lift the loads by overcoming this friction.

If friction is present in the effort side, then the friction can be said as the extra effort required overcoming the frictional force. If friction is present in load side, then the friction can be said as the extra load which is to be lifted.

Mathematically: $F_{\text{effort}} = P - \frac{W}{V.R}$ and $F_{\text{load}} = (P \times V.R) - W$

Some expression can be considered:

SOLVED PROBLEM

Q.1) In a certain weight lifting machine a weight of 1 kN is lifted by an effort of 25 N. While the weight moves by 100 mm, the point of application of effort moves by 8 m. Find the M.A, V.R and efficiency of the machine.

Ans: Data Given:

Weight (W) = 1 kN = 1000 N

effort (P) = 25 N

displacement of weight (x) = 0.1 m

displacement of effort (y) = 8 m

$$\text{Mechanical advantage (M.A)} = \frac{W}{P} = \frac{1000}{25} = 40$$

$$\text{Velocity ratio (V.R)} = \frac{y}{x} = \frac{8}{0.1} = 80$$

$$\text{Efficiency of the machine } (\eta) = \frac{M.A}{V.R} = \frac{40}{80} = 0.5 = 50\% \quad (\text{ANS})$$

Q.2) What load can be lifted by an effort of 120 N, if the velocity ratio is 18 and efficiency of the machine at this load is 60%? Determine the law of the machine, if it is observed that an effort of 200 N is required to lift a load of 2600 N and find the effort required to run the machine at a load of 3.5 kN.

Ans: Data Given:

Effort (P) = 120 N velocity ratio (V.R) = 18 efficiency (η) = 60% = 0.6

Load lifted by the machine:

Mechanical advantage (M.A) = V.R \times η = 18 \times 0.6 = 10.8

Load lifted by the machine (W) = M.A \times P = 10.8 \times 120 = 1296 N (**ANS**)

Law of machine:

Case-1: effort (P) = 120 N, load (W) = 1296 N

Case-2: effort (P) = 200 N, load (W) = 2600 N

Case-3: load (W) = 3.5 kN = 3500 N, effort required (P) = ?

For case-1: law of machine is 120 = m \times 1296 + C (1)

For case-2: law of machine is 200 = m \times 2600 + C (2)

Subtracting equation-2 from 1 we get: $(200-120) = m \times (2600 - 1296)$

$$\Rightarrow 80 = 1304 m \quad \Rightarrow m = \frac{80}{1304} = 0.06$$

Substituting the value of 'm' in equation -2 we can obtain the value for 'C'.

$$C = 44$$

Law of machine is given by: $P = 0.06 W + 44$

For case-3: effort required $(P) = 0.06 \times 3500 + 44 = 254 \text{ N}$ (ANS)

EXERCISE

- Q.1)** In a lifting machine an effort of 31 N raised a load of 1 kN. If the efficiency of the machine is 0.75, what is its V.R? If on this machine an effort of 61 N raised a load of 2 kN, what is now the efficiency? What will be the effort required to raise the load of 5 kN?
- Q.2)** In a certain lifting machine, the velocity ratio is 15 and its efficiency is 70%. Find out the load to be lifted when an effort of 60 N is applied.
- Q.3)** For a simple lifting machine, the velocity ratio is 60. An effort equal to 120 N is required to lift the load of 5 kN. Find whether the machine is reversible or not.
- Q.4)** In a simple lifting machine, an effort of 60 N lifts a load of 740N. The velocity ratio of the machine is 20. Determine the efficiency and friction in terms of effort and load.
- Q.5)** In a simple lifting machine, it is seen that 30 percent of the effort applied to lift load is lost in friction. Determine the load that can be lifted through a height of 0.9 m, if an effort of 270 N is applied through 15 m. Also find out the mechanical advantage and efficiency of the machine.
- Q.6)** In a simple lifting machine, an effort of 80 N lifts a load of 1200 N. If the velocity ratio of the machine is 18, find out efficiency of the machine and friction in terms of effort and load.

Various types of Simple Lifting Machines:

Simple wheel and axle:

It is a simple lifting machine which consists of a wheel of diameter 'D' and an axle of diameter 'd' fitted on the shaft. The shaft is provided by ball bearings to minimize frictional resistance.

One rope or string is mounted over the axle, at the end of which load is attached. Another string is mounted over the wheel at the end of which effort is applied. This mechanism is shown in figure.

When the effort is applied the wheel and axle rotates in same direction. The string is attached in such a manner that when rope of the wheel un winds the rope of the axle winds and the load rises up. When the effort is removed the rope on the wheel winds and the rope on the axle un winds, which gives the reverse motion of load.

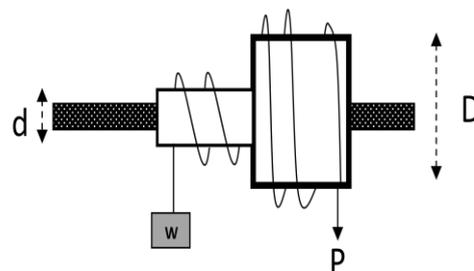

Displacement of effort in one rotation = πD

Displacement of load in one rotation = πd

$$\text{Velocity ratio} = \frac{\pi D}{\pi d} = \frac{D}{d}$$

$$\text{Mechanical Advantage} = \frac{W}{P}$$

$$\text{Efficiency} = \frac{MA}{VR}$$

Single Purchase Crab Winch:

A single purchase crab winch is a simple lifting machine which consists of a load drum, two toothed wheels, rope and a handle. The arrangement of this machine for lifting load is shown in figure.

In this machine a rope is fixed to the drum and wound around it. The free end of the rope carries a load 'W'. A toothed wheel A is mounted on the load drum and another toothed wheel B (pinion) is geared with the toothed wheel A.

When the handle is rotated, the toothed wheel fitted to it rotates, which rotates the pinion. According to the arrangement when effort is given at the end of the handle the load is moved by the machine.

- Let, T_1 = number of teeth on main gear/spur gear A
 T_2 = number of teeth on the pinion B
 l = length of the handle
 r = radius of the load drum
 W = load lifted
 P = effort applied to lift the load

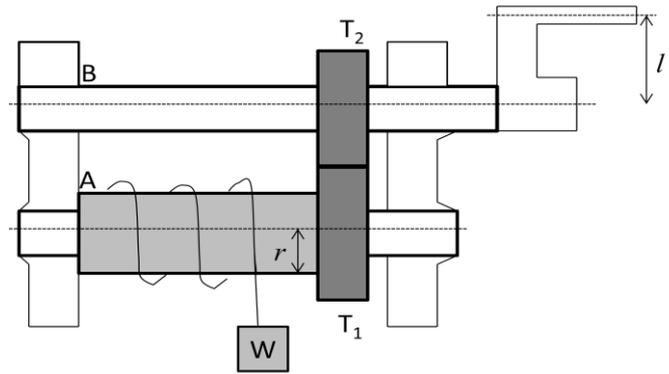

Single purchase crab winch

Distance moved by the effort in one revolution of the handle = $2\pi l$

Number of revolutions made by the pinion B = 1

Number of revolution made by the wheel A = $\frac{T_2}{T_1}$

Number of revolution made by the load drum = $\frac{T_2}{T_1}$

Distance moved by the load = $2\pi r \times \frac{T_2}{T_1}$

$$\therefore \text{Velocity ratio (V.R)} = \frac{\text{distance moved by effort}}{\text{distance moved by load}} = \frac{2\pi l}{2\pi r \times \frac{T_2}{T_1}} = \frac{1}{r} \times \frac{T_1}{T_2}$$

$$\therefore \text{Mechanical Advantage (M.A)} = \frac{W}{P} \quad \text{and} \quad \text{efficiency} = \frac{\text{M.A}}{\text{V.R}}$$

Screw jack:

A screw jack is a simple lifting machine which lifts or lowers heavy loads with a smaller effort. In a screw jack effort is applied at the end of a lever/handle or by using a pulley to lift heavy loads given on its load drum. A rotating screw passes through the jack and attached with collar to move axially, as a result it is able to lift the loads in vertically up or downward direction.

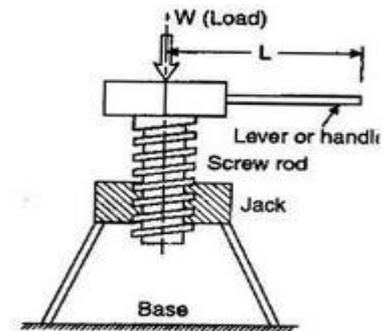

- Let P_1 = effort applied at the end of lever
 W = load to be lifted by screw jack
 l = length of the lever
 p = pitch of the screw
 d = mean diameter of screw
 α = helix angle
 μ = coefficient of friction = $\tan \phi$

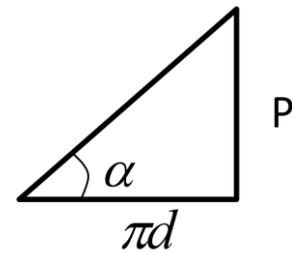

Figure-2

From figure-2 we obtained: $\tan \alpha = \frac{p}{\pi d}$

Effort required to raise the load (P) = $W \times \tan (\alpha + \phi)$

Effort required to lower the load (P) = $W \times \tan (\alpha - \phi)$

Torque required to raise the load = $W \times \tan (\alpha + \phi) \times \frac{d}{2}$

Torque required to lower the load = $W \times \tan (\alpha - \phi) \times \frac{d}{2}$

Torque produced at the end of the lever = Torque required to raise or lower the load

$$\Rightarrow P_1 \times l = P \times \frac{d}{2}$$

$$\text{Mechanical Advantage} = \frac{\text{load lifted}(W)}{\text{effort applied}(P)}$$

$$\text{Velocity ratio} = \frac{\text{distance moved by the effort}}{\text{distance moved by the load}} = \frac{2\pi l}{p}$$

Efficiency of screw jack =

$$\frac{MA}{VR} = \frac{\text{load}}{\text{effort}} \times \frac{p}{2\pi l} = \frac{W \times p \times 2l}{W \times \tan (\alpha + \phi) \times 2\pi d} = \frac{p}{\pi d \times \tan (\alpha + \phi)} = \frac{\tan \alpha}{\tan (\alpha + \phi)}$$

Worm & Worm wheel:

A worm is a threaded shaft and worm wheel is a spur gear. The teeth of spur gear engage within the threads of the worm.

In figure the worm and worm wheel arrangement is shown. A load drum of diameter 'd' is mounted on the shaft on which worm wheel is fixed. The worm is fixed with wheel A over which a rope is wound to apply effort. Effort applied at the wheel A lifts the load W which is carried by a string at its free end. Other end of the string is wound on the drum. One rotation of the worm rotates the worm wheel through one tooth.

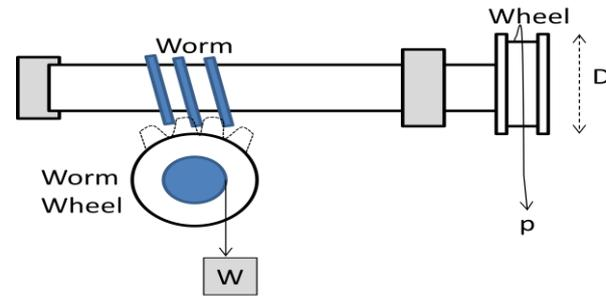

Worm and Worm wheel

Let D = diameter of the effort wheel r = radius of the load drum
 W = load lifted P = effort applied to lift the load
 T = number of teeth on the worm wheel

Distance moved by the effort in one revolution of the wheel = πD

If the worm is single threaded the load drum will move through $\frac{1}{T}$ revolution

Distance through which load will move = $\frac{2\pi r}{T}$

Velocity ratio (V.R) = $\frac{\text{dis tan ce moved by the effort}}{\text{dis tan ce moved by the load}} = \frac{\pi D}{\frac{2\pi r}{T}} = \frac{DT}{2r}$

Mechanical Advantage (M.A) = $\frac{W}{P}$ and Efficiency (η) = $\frac{MA}{VR}$

If the worm is double threaded: $V.R = \frac{DT}{2 \times 2r} = \frac{DT}{4r}$

EXERCISE

- Q.1)** A simple wheel and axle has wheel and axle of diameters 300 mm and 30 mm respectively. What is the efficiency of the machine if it can lift a load of 900 N by an effort of 100 N?
- Q.2)** In a wheel and axle machine the diameter of the wheel is 100 cm and that of axle is 10 cm. The rope thickness on the wheel is 3 mm and that on the drum is 6 mm. In this machine a load of 500 N is lifted by an effort of 100 N. Determine the efficiency of the machine and state whether the machine is reversible or not.
- Q.3)** In a single purchase crab winch the number of teeth on pinion is 25 and that on the spur wheel 100. Radii of the drum and the handle are 50 mm and 300 mm respectively. Find the efficiency of the machine.
- Q.4)** In a single purchase crab winch, the number of teeth on pinion is 25 and on the spur wheel is 250, radius of drum and handle are 1500 mm and 300 mm respectively. Find the efficiency of the machine and the effect of friction, if an effort of 20 N can lift a load of 300 N.
- Q.5)** A worm and worm wheel with 40 teeth on the worm wheel has effort wheel of 300 mm diameter and load drum of 100 mm diameter. Find the efficiency of the machine, if it can lift a load of 1800 N with an effort of 24 N.

DYNAMICS

(Chapter 5)

Dynamics	# It is the branch of science which deals with characteristics of bodies or particles in motion. It is classified as <i>Kinematics</i> and <i>Kinetics</i> .
Kinematics	# It is the study of motion of a particle or body without considering the forces causing the motion of it.
Kinetics	# It is the study of motion of the body or particle by considering the forces causing the motion of it.
Motion	# A body is said to be in <i>motion</i> if it is changing its position with respect to its surrounding. A body is at <i>rest</i> when it does not change its position with respect to its surrounding.
Rectilinear motion	# When a body moves along straight line, its motion is called as rectilinear motion.
Curvilinear motion	# When a body moves along a curved line, its motion is known as curvilinear motion.
Rotary or circular motion	# When a body moves along a circular path, its motion is called as circular or rotary motion.
Speed	# It is the rate at which a moving particle/body covers its path. It is a scalar quantity. It is denoted by 'v'. The S.I unit of speed is (m/s). Average speed is the ratio of total distance travelled and total time taken.
Displacement	# The distance travelled by a particle/body along a straight line. It is a vector quantity. It is denoted by 's'. The S.I unit of displacement is (m).
Velocity	# It is the rate of change of displacement of the particle. It is a vector quantity. It is given by the ratio of displacement and time. It is denoted by 'v'. The S.I unit of velocity is (m/s).
Acceleration	# It is the rate of change of velocity. It is a vector quantity. It is given by the ratio of velocity and time. It is denoted by 'a'. The S.I unit of acceleration is (m/s ²). <i>Acceleration</i> is taken as the rate of increase of velocity of the moving particle. <i>Retardation</i> is the rate of decrease of velocity of the moving particle.
Uniform velocity & Variable velocity	# When a particle passes through equal displacements in equal intervals of time, the velocity is called as <i>uniform velocity</i> . When a particle does not pass through equal displacements in equal intervals of time, the velocity is called as <i>variable velocity</i> .
Uniform & Variable acceleration	# If the acceleration of the moving particle remains constant, it is called as <i>uniform acceleration</i> . If the acceleration of the moving particle does not remain constant, it is called as <i>non-uniform or variable acceleration</i> .

Laws of Motion:

♣ Newton's first law of motion:

It states that, "Everybody continuous in its state of rest or of uniform motion in a straight line when there is no force acting on the body to change its state of rest or uniform motion".

This law is also known as *law of inertia*.

♣ Newton's second law of motion:

It states that, "the rate of change of momentum is directly proportional to the external force and takes place in the same direction of force". This law gives us the fundamental equation of dynamics.

Consider a body moving in a straight line whose velocity changes during this time.

Let, m = mass of the body u = initial velocity of the body

v = final velocity of the body a = acceleration due to gravity

t = time required to change the velocity from 'u' to 'v'

F = force required to change velocity from 'u' to 'v' in time 't' second

Initial momentum = $m.u$

Final momentum = $m.v$

$$\text{Rate of change of momentum} = \frac{mv - mu}{t} = \frac{m(v - u)}{t}$$

$$\text{We know that, } v = u + at \quad \Rightarrow a = \frac{v - u}{t}$$

$$\therefore \text{Rate of change of momentum} = m.a$$

According to 2nd law, rate of change of momentum is directly proportional to external force.

$$\therefore \text{Rate of change of momentum} = \text{external force} = m.a$$

♣ Newton's third law of motion:

It states that, "for every action there is equal and opposite reaction".

♣ D-Alembert's principle:

It states that, "the system of forces acting on a body in motion is in dynamic equilibrium with the inertia force of the body".

From Newton's second law, $F = m.a \Rightarrow F - ma = 0$.

This equation is known as equation of dynamic equilibrium.

In this equation, F = external force applied on the body

$(m.a)$ = imaginary force applied opposite to the direction of F or motion of the body (*Inertia force*)

Displacement-time graph:

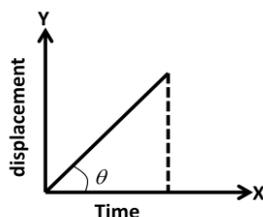

(When the velocity is uniform)

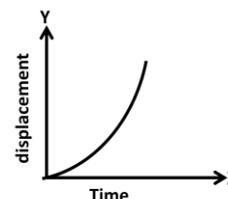

(When the velocity is variable)

Velocity-time graph:

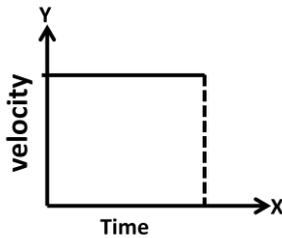

(when the velocity is uniform)

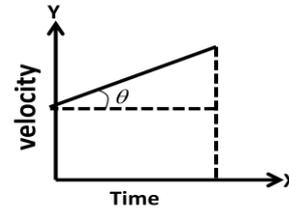

(when the velocity is variable)

Motion of a particle acted upon by a constant force:

Consider a particle in linear motion, which is moving with uniform acceleration ‘a’.

Let, u = initial velocity of the body v = final velocity of the body
 t = time taken to change velocity S = distance travelled by the particle during time ‘t’
 a = uniform acceleration

$$\text{Acceleration (a)} = \frac{\text{final velocity} - \text{initial velocity}}{\text{time taken for the change of velocity}} = \frac{v - u}{t}$$

$$\Rightarrow at = (v - u) \quad \Rightarrow \mathbf{v = u + at} \quad \text{----- (1)}$$

Distance travelled by the particle during this time (S) = $V_{\text{average}} \times \text{time}$

$$\Rightarrow S = \frac{u + v}{2} \times t \quad \Rightarrow S = \frac{u + u + at}{2} \times t = \frac{2ut + at^2}{2} \quad \Rightarrow \mathbf{S = ut + \frac{1}{2}at^2} \quad \text{----- (2)}$$

Distance travelled by the particle during this time (S) = $V_{\text{average}} \times \text{time}$

$$\Rightarrow S = \frac{u + v}{2} \times t \quad \left(\text{From equation-1 we get: } t = \frac{v - u}{a} \right)$$

$$\Rightarrow S = \frac{u + v}{2} \times t = \left(\frac{u + v}{2} \right) \times \left(\frac{v - u}{a} \right) = \frac{v^2 - u^2}{2a}$$

$$\Rightarrow \mathbf{v^2 - u^2 = 2as} \quad \Rightarrow \mathbf{v^2 = u^2 + 2as} \quad \text{----- (3)}$$

Distance travelled in nth second:

Let, S_n = distance travelled by the body in ‘n’ second
 S_{n-1} = distance travelled by the body in (n-1) second
 S = distance travelled by the body in nth second = $S_n - S_{n-1}$

We can write: $S_n = un + \frac{1}{2}an^2$ and $S_{n-1} = u.(n-1) + \frac{1}{2}a.(n-1)^2$

Distance travelled in nth second (S) = $S_n - S_{n-1} = u + \frac{a}{2}(2n-1)$ ----- (3)

Motion under force of gravity:

If the body falls due gravity then the equations of motion can be written as follows:

$$\mathbf{v = u + gt} \quad \text{----- (1)}$$

$$\mathbf{v^2 = u^2 + 2gs} \quad \text{----- (2)}$$

$$\mathbf{S = ut + \frac{1}{2}gt^2} \quad \text{----- (3)}$$

SOLVED PROBLEM

Que-1) A balloon of gross weight W falls vertically downward with constant acceleration a . What amount of ballast Q must be thrown out in order to give the balloon an equal upward acceleration a . Neglect air resistance.

Ans:

Case-1: *when balloon is falling*

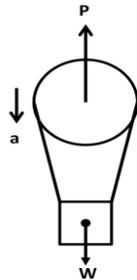

The equation of motion for this case is

$$\frac{W}{g}a = W - P \quad \text{----- (1)}$$

Case-1: *when balloon is rising*

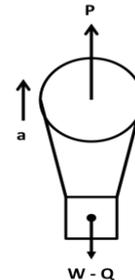

The equation of motion for this case is

$$\frac{W}{g}a = P - (W - Q) \quad \text{----- (2)}$$

On solving equation 1 and 2 we get: $Q = \frac{2Wa}{g + a}$ (Ans)

Que-2) On turning a corner a motorist rushing at 20 m/s, finds a child on the road 50 m ahead. He instantly stops the engine and applies brakes, so as to stop the car within 10 m of the child. Calculate (i) retardation (ii) time required to stop the car.

Ans: Data given:

Initial velocity (u) = 20 m/s, final velocity (v) = 0,
distance travelled by the car (s) = 50 – 10 = 40 m

We know that: $v^2 = u^2 + 2as \Rightarrow 0 = 20^2 + 2 \times a \times 40 = 400 + 80a$

$$\Rightarrow \text{retardation } (a) = -\frac{400}{80} = -5 \text{ m/s}^2$$

We know that: $v = u + at \Rightarrow 0 = 20 + (-5) \times t$

$$\Rightarrow \text{time taken } (t) = \frac{20}{5} = 4 \text{ sec}$$

\therefore Thus retardation is -5 m/s^2 and time taken is 4 sec. (Ans)

Que-3) A motor car takes 10 seconds to cover 30 metres and 12 seconds to cover 42 metres. Find the uniform acceleration of the car and its velocity at the end of 15 seconds.

Ans: Data given:

Case-1: When time (t) = 10 sec, distance covered (s) = 30 m

Case-2: When time (t) = 12 sec, distance covered (s) = 42 m

Let, u = initial velocity of the car and a = uniform acceleration

$$\text{Distance travelled by the car in 10 sec} = 30 = ut + \frac{1}{2}at^2 = u \times 10 + \frac{1}{2} \times a \times 10^2$$

$$\Rightarrow 30 = 10u + 50a \quad \text{----- (1)}$$

$$\text{Distance travelled by the car in 12 sec} = 42 = ut + \frac{1}{2}at^2 = u \times 12 + \frac{1}{2} \times a \times 12^2$$

$$\Rightarrow 42 = 12u + 72a \quad \text{----- (2)}$$

Solving the two equations by elimination method we get:

$$5 \times 42 = 5 \times (12u + 72a) \Rightarrow 210 = 60u + 360a \quad \text{----- (3)}$$

$$6 \times 30 = 6 \times (10u + 50a) \Rightarrow 180 = 60u + 300a \quad \text{----- (4)}$$

Subtracting equation 4 from 3 we get: $30 = 60a \Rightarrow a = \frac{30}{60} = 0.5 \text{ m/s}^2$ (Ans)

Substituting the value of 'a' in equation-4 we get:

$$180 = 60u + 300 \times 0.5 \Rightarrow 60u = 180 - 150 = 30 \Rightarrow u = \frac{30}{60} = 0.5 \text{ m/s}^2$$

Velocity of the car after time 15 sec (v) = $u + at = 0.5 + 0.5 \times 15 = 8 \text{ m/s}$ (Ans)

Que-4) A body is released from a great height falls freely towards earth. Another body is released from the same height exactly one second later. Find the separation between both the bodies, after two seconds of the release of second body.

Ans: Data given:

Initial velocities of both the bodies (u) = 0

Time taken by the first body (t_1) = 3 sec

Time taken by the second body (t_2) = 3-1 = 2 sec

Distance covered by the first body after 3 sec = (S_1) = $ut_1 + \frac{1}{2}gt_1^2$

$$= 0 + \frac{1}{2} \times 9.8 \times 3^2 = 44.1 \text{ m} \quad \text{----- (i)}$$

Distance covered by the 2nd body after 2 sec = (S_2) = $ut_2 + \frac{1}{2}gt_2^2$

$$= 0 + \frac{1}{2} \times 9.8 \times 2^2 = 19.6 \text{ m} \quad \text{----- (ii)}$$

\therefore Separation between bodies = $S_1 - S_2 = 44.1 - 19.6 = 24.5 \text{ m}$ (Ans)

Que-5) A body of mass 5 kg starts from rest and attains a speed of 4 m/s in a horizontal distance of 12 m. Assume coefficient of friction is 0.25. Find out the minimum force P acting on the body.

Ans: consider the free body diagram of the body.

Initial velocity of the body = $u = 0$

We know that; $v^2 = u^2 + 2as \Rightarrow a = \frac{v^2 - u^2}{2s}$

$$\Rightarrow a = \frac{4^2 - 0}{2 \times 12} = 16/24 = 0.6667 \text{ m/s}^2$$

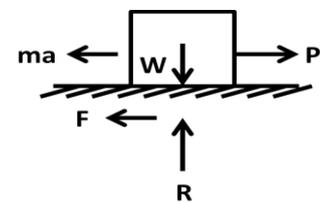

Reaction $R = W = m.g = 5 \times 9.81 = 49.05 \text{ N}$

Frictional force $F = \mu R = 0.25 \times 49.05 = 12.2625 \text{ N}$

Inertia force = $m.a = 5 \times 0.6667 = 3.3334 \text{ N}$

Taking the sum of all horizontal forces equal to zero, we get;

$P - F - ma = 0 \Rightarrow P = F + ma = 12.2625 + 3.3334 = 15.5955 \text{ N}$ (Ans)

Que-6) A stone is dropped from the top of the tower of 50 m high. At the same time another stone is thrown upwards from the foot of the tower with a velocity of 25m/s. When and where the two stones cross each other?

Ans: Data given:

Height of the tower (h) = 50 m,

Consider the motion of first stone:

Let, t = time taken for the stones to cross each other,

initial velocity (u) = 0

$$\text{Distance travelled by the stone (s)} = ut + \frac{1}{2}gt^2 = 0 + \frac{1}{2}gt^2 = 0.5gt^2 \quad \text{----- (1)}$$

Consider the motion of second stone:

initial velocity = - 25 m/s, distance travelled = 50 – s

$$\text{Distance travelled by the stone} = 50 - s = ut + \frac{1}{2}gt^2 = -25t + 0.5gt^2 \quad \text{----- (2)}$$

$$\text{Adding equation 1 and 2 we get: } 50 = 25t \quad \Rightarrow t = \frac{50}{25} = 2\text{sec} \quad (\text{Ans})$$

Point where the stones cross each other:

Substituting the value of t = 2 sec, we get;

$$s = 0.5gt^2 = 0.5 \times 9.8 \times 2^2 = 19.6 \text{ m} \quad (\text{Ans})$$

ASSIGNMENT

Que-1) A block weighing 2500 N rests on a horizontal plane for which coefficient of friction is 0.20. This block is pulled by a force of 1000 N, which is acting at an angle of 30° to the horizontal. Find the velocity of block after it moves 30 m starting from rest. (Ans: 7.914 m/s)

Que-2) Two bodies of mass 100 kg and 40 kg are connected by a thread and move along a horizontal plane under the action of a force 450 N applied to the first body of mass 100 kg as shown in figure. The coefficient of friction between the sliding surfaces of bodies and the plane is 0.3. Determine the acceleration of the two bodies and the tension in the thread using D'Alembert's principle. (Ans: 0.271 m/s², 128.57 N)

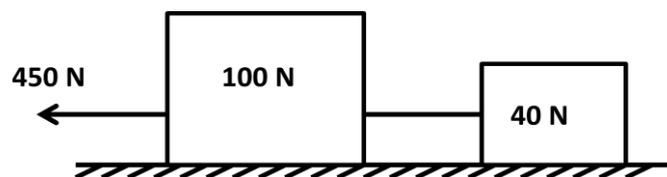

Que-3) A man weighing 800 N stands on the floor of a lift. Find the pressure exerted on the floor when (i) the lift moves upwards with an acceleration of 3 m/s² and (ii) the lift moves downwards with an acceleration of 3 m/s². (Ans: 979.35 N, 520.64 N)

Que-4) A gun of mass 30 kg fires a bullet of mass 25 grams with a velocity of 230 m/s. Find the velocity with which the gun recoils. (Ans: 0.19 m/s)

Que-5) A bullet of mass 10 gram is fired horizontally with a velocity of 1000 m/s from a gun of mass 50 kg. Find (i) velocity with which the gun will recoil and (ii) force necessary to bring the gun to rest in 250 mm. (Ans: 0.2 m/s, 4 N)

Que-6) Two blocks weigh 50 N and 25 N are connected at the two ends of a string passing over a smooth pulley. The block weighing 50 N is placed on a smooth horizontal surface while the block weighing 25 N is hanging free in air. Find (i) acceleration of the system and (ii) tension in the string. (Ans: $a = 3.27 \text{ m/s}^2$, $T = 16.667 \text{ N}$)

Work:

If a body is subjected to force ‘F’ and displaced by distance ‘S’ due to the action of force, then it is said that some work is done on the body. It is given by the product of force and displacement.

Mathematically: $\text{Work done} = F \times S$ in joules (1 Joule = 1 N-m)

Force displacement diagram: (graphical representation of work)

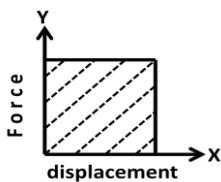

When the force is uniform



When the force varies uniformly from small value to maximum

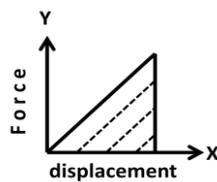

When the force varies uniformly from zero to maximum

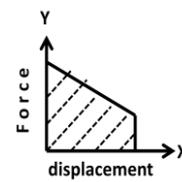

When the force varies uniformly from maximum to some value

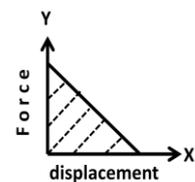

When the force varies uniformly from maximum to zero

Power:

It is the rate of doing work. It is measured by the work done per second. Its unit is Joule/sec or Watt.

Mathematically: $\text{Power} = \frac{\text{workdone}}{\text{time}}$

Indicated Power:

It is the actual power developed by the engine. It is measured by the indicator diagram.

Indicated horse power is the measure of indicated power in M.K.S units or in terms of horse power. Indicated power is given in Watt. $1 \text{ H.P} = 75 \text{ kg-m/s}$ $1 \text{ kW} = 1000 \text{ kJ/s}$

Brake Power:

It is the actual power available at the engine shaft.

It is measured by applying frictional brake to the shaft. So, it is known as brake power. It is always less than the indicated power.

Frictional Power Loss:

It is the power lost in an engine due to friction. It is given by the difference between indicated power and brake power.

Energy:

It is the capacity of doing work. Its unit is Joule. $1 \text{ joule} = 1 \text{ N-m/s}$

Potential Energy:

It is the capacity to do work due to the position of the body.

Consider a body of mass ‘m’ at a height ‘h’ above the ground level. When it is coming down it possesses some energy which is called as potential energy.

Work done = force \times distance = weight \times height = $mg \times h$

$\therefore \text{Potential energy} = m.g.h$

Kinetic Energy:

It is the capacity to do work due to the motion of the body.

Consider a body of mass 'm' moving through a distance 's' with a velocity 'u' and coming to rest. As the body is coming into rest, its final velocity $v = 0$.

We know that; $v^2 - u^2 = 2as \Rightarrow 0 - u^2 = 2as \Rightarrow a = \frac{-u^2}{2s} \Rightarrow a = \frac{u^2}{2s}$ (retardation)

Work done due to motion = force \times distance = $F \times s = m \times a \times s = m \times \left(\frac{u^2}{2s}\right) \times s = \frac{1}{2} mu^2$

$$\text{Kinetic energy} = \frac{1}{2} mu^2$$

If the body is moving with a velocity of 'v', then Kinetic energy = $\frac{1}{2} mv^2$

Law of conservation of energy:

It states that, "the energy can neither be created nor destroyed, but it can be transformed from one form to another". Thus total energy possessed by the body always remains constant.

Proof:

Consider a body of mass 'm' at a height 'h' above the ground level at position A as shown in figure.

Consider three positions of the body A, B and C.

At position A:

The kinetic energy is zero because the body is at rest.

Potential energy = $m \cdot g \cdot h$

Total energy = KE + PE = $0 + m \cdot g \cdot h = m \cdot g \cdot h$

At position B:

Let the body falls freely to a distance 'x' from A with velocity 'v' to a new position B.

At B potential energy is converted into kinetic energy.

We know that, $v^2 = u^2 + 2gx = 0 + 2gx = 2gx$

$$\Rightarrow v = \sqrt{2gx}$$

Total energy = KE + PE = $\frac{1}{2} mv^2 + mg(h-x)$

$$= \frac{1}{2} m(\sqrt{2gx})^2 + mgh - mgx = \frac{1}{2} m \times 2gx + mgh - mgx = mgh$$

When the body reaches at point C, its potential energy becomes zero and the body possesses only kinetic energy.

At point C, velocity (v) = $\sqrt{2gh}$

Kinetic energy at C = $\frac{1}{2} mv^2 = \frac{1}{2} m \times (\sqrt{2gh})^2 = mgh$

Total energy at C = KE + PE = $m \cdot g \cdot h + 0 = mgh$

From the above we include that, the sum of potential energy and kinetic energy at each level is constant. Therefore total energy in any system is always constant.

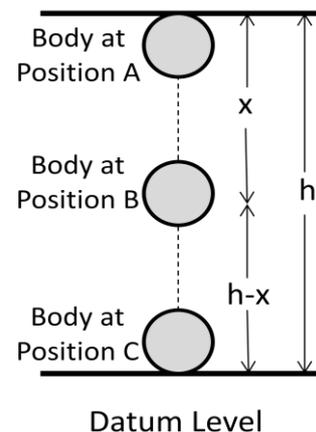

PROBLEM

Que-1) A pump lifts 40m^3 of water to a height of 50 m and delivers it with a velocity of 5 m/s. What is the amount of energy spent in this process? If the job is done in half an hour, what is the input power of the pump which has an overall efficiency of 70%?

Ans: Data given:

volume of water = 40 m^3 , height of water lifted (h) = 50 m, velocity (v) = 5 m/s,
time taken (t) = $\frac{1}{2}$ hour = 30 min = 1800 s, overall efficiency = 70% = 0.70

Work done in lifting water of 40 m^3 to a height of 50 m = weight of water \times height = $W \times h$
= $40 \times 9810 \times 50 = 19620000\text{ Nm}$

Kinetic energy at delivery of water = $\frac{1}{2} \times \frac{W}{g} \times v^2 = \frac{1}{2} \times \frac{40 \times 9810}{9.81} \times 5^2 = 500000\text{ Nm}$

Total energy spent = $19620000 + 50000 = 20120000\text{ Nm} = 20.12 \times 10^6\text{ Nm}$ (Ans)

Output power of the pump = Output energy spent/second = $\frac{20120000}{1800} = 11177.8\text{ watt}$
= 11.1778 kW

Input power = $\frac{11.1778}{0.7} = 15.9583\text{ kW}$ (Ans)

Que-2) Calculate the time taken by a water pump of power 500 W to lift 2000 kg of water to a tank, which is at a height of 15m from the ground? Take $g = 10\text{ m/s}^2$.

Ans: Data given:

power (P) = 500 W, mass of water (m) = 2000 kg, height of tank (h) = 15 m

Power (P) = $\frac{mgh}{t}$ Time taken (t) = $\frac{mgh}{P} = \frac{2000 \times 10 \times 15}{500} = 600\text{ s}$ (Ans)

Que-3) A car weighing 1000 kg and travelling at 30 m/s stops at a distance of 50 m decelerating uniformly. What is the force exerted on it by the brakes? What is the work done by the brakes?

Ans: Data given:

mass of car (m) = 1000 kg, initial velocity of car (u) = 30 m/s, distance covered (s) = 50 m
Since the car stops, final velocity (v) = 0

Work done by the brakes = kinetic energy of the car

$$\Rightarrow W = \frac{1}{2} mu^2 = \frac{1}{2} \times 1000 \times 30^2 = 450000\text{ J}$$

$$\text{Work done} = F \times S \quad \Rightarrow 450000 = F \times 50 \quad \Rightarrow F = \frac{450000}{50} = 9000\text{ N}$$

\therefore Force exerted by the brakes is 9000 N.

ASSIGNMENT

- Que-1)** A spring is stretched by 60 mm by the application of an external load. Calculate the work done, if the force required to stretch 1 mm of spring is 15 N. (Ans: 27 J)
- Que-2)** A vehicle of mass 25 tonnes is moving on a horizontal path with a constant speed of 15 m/s. Calculate the power of the engine, if the frictional resistance is 75 N/tonne. Efficiency of the engine is 85%. (Ans: 33.08 kW)
- Que-3)** The kinetic energy of a body is 2500 kJ corresponding to a velocity of 700 m/s. Estimate the loss in kinetic energy when its velocity is reduced to 450 m/s. (Ans: 1467.25 kJ)
- Que-4)** A vehicle accelerates a body of mass 150 kg from rest to a speed of 60 km/hr. Calculate the work done on the body by the vehicle. Also calculate the change in kinetic energy of the vehicle if its velocity reduces to 10 km/hr. (Ans: 20841.66 J, 20262.87 J)

Momentum:

- ♣ Momentum is the motion contained in a body.
- ♣ It is the product of mass and velocity of the moving body.
- ♣ It is a vector quantity.
- ♣ Mathematically: $\text{Momentum} = \text{mass of the body} \times \text{velocity}$
- ♣ Its unit is kg-m/s in S.I.

Impulse:

- ♣ Impulse is the product of force and time.
- ♣ Impulse has the same units as momentum.
- ♣ Impulse is momentum at a particular instant of time.
- ♣ It is also a vector quantity.
- ♣ Mathematically: $\text{Impulse} = \text{Force} \times \text{time}$

Impulse-Momentum Equation:

$$F \times t = m (v - u)$$

Law of conservation of linear momentum:

It states that, “the total momentum of two bodies remains constant after their collision or other mutual action”.

Mathematically: $m_1 u_1 + m_2 u_2 = m_1 v_1 + m_2 v_2$

Where: m_1 = mass of the first body u_1 = initial velocity of the first body
 v_1 = final velocity of the first body
 m_2, u_2, v_2 are the corresponding values for the second body

Proof:

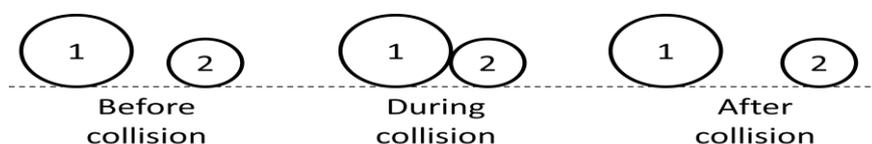

Consider two bodies 1 and 2 respectively moving in same direction and subjected to direct impact.

Let, m_1 = mass of the body 1
 m_2 = mass of the body 2
 u_1 = initial velocity of body 1 before collision
 u_2 = initial velocity of body 2 before collision
 v_1 = final velocity of body 1 after collision
 v_2 = final velocity of body 2 after collision

$$\text{Total momentum before collision} = m_1u_1 + m_2u_2$$

$$\text{Total momentum after collision} = m_1v_1 + m_2v_2.$$

We know that impulse of a force is equal to the change in momentum produced by the force.

$$\text{Let, } I_1 = \text{impulse of force produced by body 2 on body 1} = -(m_1v_1 - m_1u_1)$$

$$I_2 = \text{impulse of force produced by body 1 on body 2} = (m_2v_2 - m_2u_2)$$

We know that: $I_1 = I_2$

$$\Rightarrow -(m_1v_1 - m_1u_1) = (m_2v_2 - m_2u_2)$$

$$\Rightarrow m_1u_1 + m_2u_2 = m_1v_1 + m_2v_2$$

From this expression we conclude that; when no external force acts on the body, the total momentum before impact is equal to total momentum after impact.

Collision of elastic bodies:

When a body in motion collides with another body (may be in rest or in motion) the two bodies compress each other. Then the two bodies displaces from their position to a new position with different velocities. This is the effect of collision.

If the two bodies come back to their original shape due to their elasticity, then it is known as the collision of elastic bodies.

Collision of two elastic bodies:

When two bodies in motion collide with each other, the two bodies compress each other. Then the two bodies displaces from their position to a new position with different velocities. But the sum of momentum of both bodies before and after collision remains same.

Consider two bodies A and B of masses m_1 and m_2 moving in a straight line having a direct impact.

Let, u_1 = initial velocity of body A before collision
 u_2 = initial velocity of body B before collision
 v_1 = final velocity of body A after collision
 v_2 = final velocity of body B after collision

According to law of conservation of momentum: $m_1u_1 + m_2u_2 = m_1v_1 + m_2v_2$

Coefficient of restitution:

It is defined as the ratio between the velocity of separation and velocity of approach.

Consider two bodies A and B having a direct impact as shown in figure.

Let, u_1 = initial velocity of the body A

v_1 = final velocity of the body A

u_2 and v_2 are the initial and final velocities of body B respectively.

If u_1 is greater than u_2 , then direct impact will happen.

Velocity of approach = $(u_1 - u_2)$

After impact, the v_2 is greater than v_1 .

Velocity of separation = $(v_2 - v_1)$

According to Newton's law of collision of elastic bodies, "velocity of separation is directly proportional to velocity of approach".

Thus we can write: $(v_2 - v_1) = e \times (u_1 - u_2)$

Where: e = constant of proportionality known as coefficient of restitution.

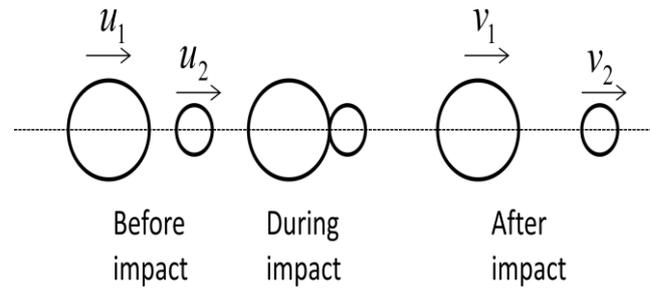

- The value of 'e' lies between 0 and 1.
- If $e = 0$, two bodies are inelastic.
- If $e = 1$, two bodies are perfectly elastic

PROBLEM

Que-1) A ball having mass 4 kg and velocity 8 m/s travels to the east. Impulse given at point 'O' makes it change direction to north with velocity 6 m/s. Find the given impulse and change in momentum.

Ans: Data given:

P_1 = initial momentum = $m \cdot v_1$
 $= 4 \text{ kg} \times 8 \text{ m/s} = 32 \text{ kg-m/s}$

P_2 = final momentum = $m \cdot v_2$
 $= 4 \text{ kg} \times 6 \text{ m/s} = 24 \text{ kg-m/s}$

From the triangle;

$$\Delta P^2 = P_1^2 + P_2^2 = m^2(v_2^2 + v_1^2)$$

$$= 4^2(6^2 + 8^2) = 16 \times 100 = 1600$$

$$\Rightarrow \Delta P = 40 \text{ kg-m/s}$$

$$\therefore \text{Impulse} = \text{Change in momentum} = 40 \text{ kg-m/s}$$

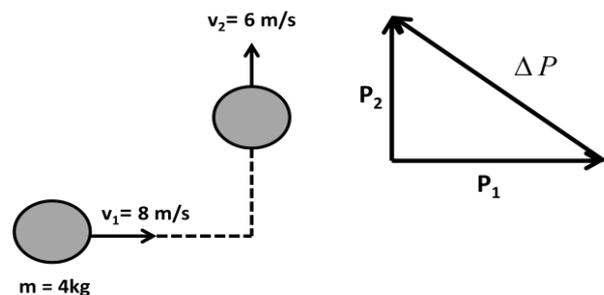

(Ans)

Que-2) Two blocks are travelling towards each other. The first has a speed of 10 cm/s and the second a speed of 60 cm/s. After the collision the second is observed to be travelling with a speed of 20 cm/s in a direction opposite to its initial velocity. If the weight of the first block is twice that of the second, determine: (i) the velocity of the first block after collision, (ii) whether the collision is elastic or inelastic.

Ans: Data given: Consider the block 1 and 2 and their velocity before and after impact.

Let m_1 and m_2 be the mass of block 1 and 2 respectively.

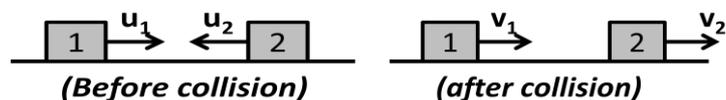

$$u_1 = 10 \text{ cm/s}, \quad u_2 = 60 \text{ cm/s}, \quad v_2 = 20 \text{ cm/s}, \quad m_1 = 2 m_2$$

$$\begin{aligned} \text{we know that;} \quad m_1 u_1 - m_2 u_2 &= m_1 v_1 + m_2 v_2 \quad \Rightarrow 2m_2 u_1 - m_2 u_2 = 2m_1 v_1 + m_2 v_2 \\ &\Rightarrow 2u_1 - u_2 = 2v_1 + v_2 \quad \Rightarrow 2 \times 10 - 60 = 2v_1 + 20 \\ &\Rightarrow 2v_1 = -60 \quad \Rightarrow v_1 = -30 \text{ cm/s} \end{aligned} \quad (\text{Ans})$$

$$\begin{aligned} \text{Sum of initial K.E of two bodies} &= \frac{1}{2} m_1 u_1^2 + \frac{1}{2} m_2 u_2^2 = \frac{1}{2} \times 2m_2 \times 10^2 + \frac{1}{2} m_2 \times 60^2 \\ &= 1900 m_2 \end{aligned}$$

$$\begin{aligned} \text{Sum of final K.E of two bodies} &= \frac{1}{2} m_1 v_1^2 + \frac{1}{2} m_2 v_2^2 = \frac{1}{2} \times 2m_2 \times (-30)^2 + \frac{1}{2} m_2 \times 20^2 \\ &= 1100 m_2 \end{aligned}$$

As the initial and final kinetic energy is not equal, the collision is inelastic. (Ans)

Que-3) *A pile hammer weighing 20 kN drops from a height of 750 mm on a pile of 10 kN. The pile penetrates 100 mm per blow. Assuming that the motion of the pile is resisted by a constant force, find the resistance to penetrate the ground.*

Ans: Data given:

initial velocity of hammer (u) = 0, distance moved (h) = 750 mm = 0.75 m,
 acceleration (a) = 9.81 m/s², weight of pile hammer (W_1) = 20 kN,
 weight of pile (W_2) = 10 kN, penetration per blow (s) = 100 mm = 0.1 m
 Let, R = resistance to penetrate the ground

Let, m_1 = mass of pile hammer = W_1/g , m_2 = mass of pile = W_2/g

$$\text{Velocity at the time of strike (} V_1) = \sqrt{2gh} = \sqrt{2 \times 9.81 \times 0.75} = 3.836 \text{ m/s}$$

Let, V = velocity of the pile and hammer after impact

Applying principle of conservation of momentum for pile and hammer, we get;

$$\begin{aligned} m_1 V_1 &= (m_1 + m_2) V \quad \Rightarrow \frac{W_1}{g} \times V_1 = \frac{W_1 + W_2}{g} \times V \quad \Rightarrow \frac{20}{9.81} \times 3.836 = \frac{20 + 10}{9.81} \times V \\ &\Rightarrow 7.82 = 3.05 V \quad \Rightarrow V = 7.82 / 3.05 = 2.56 \text{ m/s} \end{aligned}$$

Applying work energy equation to the motion of pile and hammer, we get;

$$\begin{aligned} (W_1 + W_2 - R) \times s &= \frac{W_1 + W_2}{2g} \times (u^2 - V^2) \\ &\Rightarrow (20 + 10 - R) \times 0.1 = \frac{20 + 10}{2 \times 9.81} \times (0 - 2.56^2) \quad \Rightarrow (30 - R) \times 0.1 = 10.02 \\ &\Rightarrow 30 - R = 10.02 / 0.1 = 100.2 \quad \Rightarrow R = 100.2 + 30 = 130.2 \text{ kN} \end{aligned}$$

\therefore The required resistance is 130.2 kN. (Ans)

ASSIGNMENT

- Que-1)** A ball of 0.5 N weight falls from a height of 15 m and rebounds to 10 m. Find the impulse and average force between the ball and the floor if the time during which they are in contact is (1/12) of a second. (Ans: 1.588 Ns, 19.056 N)
- Que-2)** A ball of mass 2 kg moving with a velocity of 2 m/s hits another ball of mass 4 kg at rest. After the impact, the first ball comes to rest. Calculate the velocity of the second ball after the impact and the coefficient of restitution. (Ans: 1 m/s, 0.5)
- Que-3)** A body of mass 4 kg moving with a velocity of 12 m/s overtakes a body of mass 3 kg moving with a velocity of 5 m/s in the same direction along a straight line and they coalesce to form one body. Find the velocity with which the single body will move. (Ans: 9 m/s)
- Que-4)** A mass of 300 kg falls from a height of 3 m on a pile of mass 60 kg and drives it 10 cm into the ground. Calculate: (i) the velocity with which the pile driver hits the pile, (ii) the common velocity with which the pile driver and the pile move together after impact and (iii) the average resistance of the ground to penetration. (Ans: 7.67 m/s, 6.39 m/s, 77106.6 N)

(Hint: $V_1 = \sqrt{2gh}$, $V = \frac{m_1 V_1}{m_1 + m_2}$, $R = (m_1 + m_2)g \left\{ 1 + \frac{m_1^2}{(m_1 + m_2)^2} \times \frac{h}{x} \right\}$)

REFERENCE

1. Engineering Mechanics by R.S.Khurmi & N.Khurmi, S.Chand Publication (Book)
2. Text book of Engineering Mechanics, V.K.Ray & N.Mohanty, Kalyani Publication (Book)
3. Engineering Mechanics by A.R.Basu, Dhanpatrai&Co. (Book)