

LECTURE NOTES

KIIT POLYTECHNIC

6TH SEMESTER, DIPLOMA IN MECHANICAL ENGINEERING

(As per SCTE&VT Curriculum)

Compiled by

Mr. Prasant Kumar Patra

Lecturer

(pkpatrafme@kp.kiit.ac.in)



Department of Mechanical Engineering
KIIT Polytechnic, Bhubaneswar

2021-22

CONTENT

Chapter No.	Title	Page No.
Chapter-1	Introduction	02 - 04
Chapter-2	Thermal Power Station	05 - 24
Chapter-3	Nuclear Power Station	25 - 30
Chapter-4	Diesel Electric Power Station	31 - 39
Chapter-5	Hydel Power Station	40 - 43
Chapter-6	Gas Turbine Power Station	44 - 47

INTRODUCTION

A power plant can be considered as a machinery set up that produces and delivers a flow of mechanical or electrical energy. Generators are considered as the main equipment for the electric power generation. It generates electricity when it is driven by a prime mover. On the basis of the types of prime movers used, power plants are classified.

The major power plants are,

- Steam power plant
- Diesel power plant
- Gas turbine power plant
- Nuclear power plant
- Hydroelectric power plant

Sources of Energy:

Energy sources are classified as:

- Conventional Energy Sources or Non-Renewable Energy Sources
- Non-conventional Energy Sources or Renewable Energy Sources

Conventional Energy Sources:

These sources are finite and exhaustible. Once consumed, these sources cannot be replaced. Examples of these sources are energy from Coal, timber, petroleum, lignite, natural gas, fossil fuels, nuclear fuels etc.

Non-conventional Energy Sources:

These sources are continuous and non-exhaustible. Examples of these sources are geothermal energy, wind energy, tidal energy, nuclear fusion, bio-energy, solar energy etc. These sources give energy continuously without depletion.

Captive power stations:

An electricity generation station which is used by an industrial or commercial energy consumer for its own energy consumption is known as a Captive power station. Captive power plants can exchange their surplus energy with the grid.

Central stations:

An electricity generation station which is not made for the self uses of the industries is known as a Central power station. It generates more power than the captive power plant. It is suitable for large scale power generation. These stations are located outside of the end users and connected to a high voltage transmission network. The electricity generated from these stations are purchased by the consumers.

Classification of Power Plants:

Conventional Power Plants	Non-Conventional Power Plant
<ul style="list-style-type: none"> ➤ Steam/Thermal Power Plants ➤ Diesel Power Plants ➤ Gas Turbine Power Plants ➤ Hydro-Electric Power Plants ➤ Nuclear Power Plants 	<ul style="list-style-type: none"> ➤ Solar base power plant ➤ Wind Energy Power Plant ➤ Geothermal Energy ➤ Tidal Wave Energy Power Plant ➤ Ocean Thermal energy conversion Plant ➤ Biogas, Biomass Energy Power Plant ➤ Thermoelectric Generator

Importance of Electrical Power:

The importance of electricity now day is many more than our imagination. In every field there is necessity of electricity. The importance of electric power can be understood from its wide area of application. Some of the most notable uses of electricity are: Entertainment, Healthcare, Engineering, Transport and Communication, Outdoors, Household, Commercial, Office, Fuel and Space etc.

Overview of Method of Electrical Power Generation:

The various sources which are used to generate electric power are discussed below.

Steam Power:

- Steam power plants known as Coal-fired power plants use steam as a source to generate electricity. But the flue gas emitted by the plant to the atmosphere possesses harmful gases and therefore it is not environment friendly.
- But it is now a major electricity generating plant.

Hydro Power:

- The gravitational force of flowing water is utilized in hydro power plants to run the turbines. In these plants, water is forced to possess kinetic and pressure energy which is converted into mechanical energy on the rotation of runner of the hydraulic turbine.
- It is a clean and renewable resource of from which electricity is obtained.
- As compared to fossil fuel-powered energy plants, hydroelectric power plants emit fewer greenhouse gases.
- The construction of hydroelectric power plants and dams requires huge investment.

Nuclear Power:

- Nuclear power plants generate a high amount of electricity from a nuclear fission reaction using uranium as fuel.
- Nuclear power plants require low quantities of fuel but produce a large amount of power. Once started, it run efficiently.
- It is more reliable compared to renewable sources of energy such as solar and wind.
- In these plants, water is converted into steam after receiving heat energy from the nuclear reaction and this steam is used in the turbine for energy conversion.

Diesel engine power:

- This is used for small-scale production of electric power by using diesel as fuel.
- Diesel is a non-renewable source of energy which makes these plants non-durable.
- They are installed in places where there is no easy availability of alternative power sources and are mainly used as a backup for uninterrupted power supply whenever there are outages.
- It is considered as unsuitable for high maintenance costs and diesel prices.

Wind Power:

- Wind turbines capture kinetic energy from wind and convert it into electricity. The amount of energy depends on speed of the wind.
- It is a renewable source of energy.
- Wind power projects typically require huge capital expenditure. After the wind turbines are built, operational costs involved in maintaining wind power plants are low and they are generally considered to be relatively cost-effective.

Solar Power:

- Solar energy plants convert energy from the sun into thermal or electrical energy. It gives the renewable energy sources.
- They do not require high maintenance and last for about 20 to 25 years but requires high initial cost for installation.

Tidal Power:

- Tidal energy is generated from converting energy from the force tides into power. This power is created when tides rotate submerged turbines.
- Its production is considered more predictable compared to wind energy and solar power.
- Tidal power is still not widely used.

Biomass:

- Burning organic materials produces high pressure gas that can drive a turbine-generator to make electricity.

Geothermal energy:

- Geothermal power plants utilize the internal heat of earth's crust to heat water to produce steam. This steam gives energy to the turbine-generator to produce electricity.
- Geothermal power plants are considered to be environmentally friendly and emit lower levels of harmful gases compared with coal-fired power plants.

THERMAL POWER STATION

A thermal power station or a coal fired thermal power plant uses coal as the primary fuel. Heat released from the burning of coal is used to boil the water to make superheated steam for driving the steam turbine. It is the most conventional method of generating electric power with high efficiency.

Steam Power Plant Layout:

The different types of systems and components used in steam power plant are as follows:

- Boiler
- Turbine
- Condensers
- Cooling tower
- Coal handling system
- Ash handling system
- Draught system
- Feed water treatment plant
- Pumping system
- Mountings like Safety valve, stop valve, pressure gauge and water gauge.
- Accessories like Air preheater, economizer, super heater and feed heaters
- Generator, Transformer and Electricity storage and distribution system

Layout of thermal plant can be easily understood by dividing the plant components into four circuits.

▪ Coal and ash circuit

- Coal and Ash circuit in a thermal power plant layout mainly takes care of supplying the boiler with coal from the storage for combustion and collect the ash from the boiler. Coal storage, preparation and supply to the boiler mainly handled by the coal handling plant whereas the ash collection, storage and disposal mainly handled by the ash handling plant.

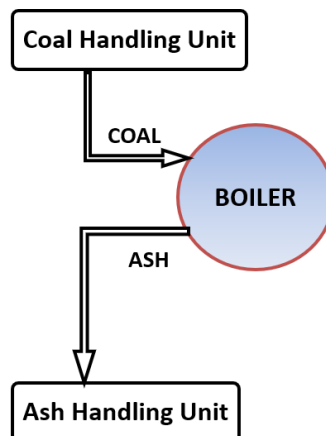

▪ Air and gas circuit

- Air and gas circuit in a thermal power plant layout mainly takes care of supplying preheated air obtained from the Air preheater to the furnace and releasing the exhaust gas from the furnace after the combustion of fuel.
- Atmospheric air is drawn into the Air preheater through the forced draught fan where air is heated by the hot flue gas coming out from the furnace.
- Flue gas having very high temperature is used in the super heater, economizer and air preheater where its heat is recovered. After that the flue gas is passes through the electrostatic precipitator for removing dust from the gas and then gas is drawn into the chimney by the induced draught fan to release the gas to atmosphere.

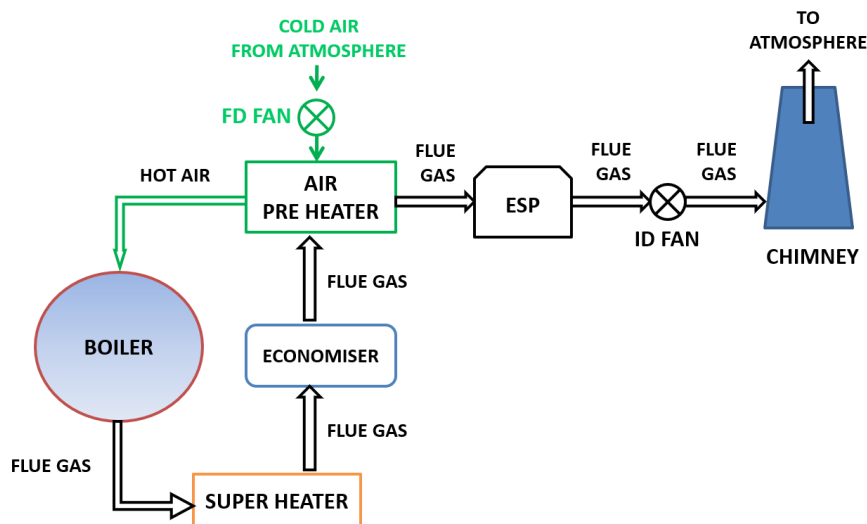

▪ **Feed water and steam circuit**

- The water and steam circuit in a thermal power plant layout mainly takes care of feeding hot water obtained from the economizer to the boiler and supplying steam obtained from the boiler to the turbine to generate power.
- The steam that is expelled by the prime mover in the thermal power plant layout is then condensed in a condenser for re-use in the boiler. The condensed water is forced through a pump into the feed water heaters. Pre heated water is supplied into the boiler. To make up for the lost steam and water make up water is feed to the boiler.

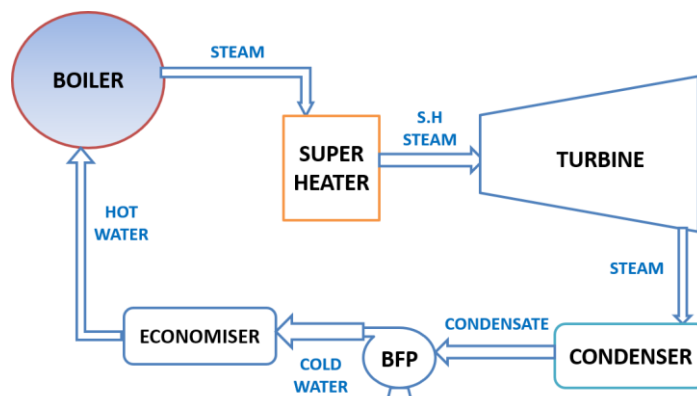

▪ **Cooling water circuit**

- Cooling water is passed through the condenser where the steam is condensed. The water after being heated by steam is discharged to Cooling tower. Cooling water circuit can also be a closed system where the cooled water is sent through cooling towers for re-use in the power plant. The cooling water circulation in the condenser of a thermal power plant layout helps in maintaining a low pressure in the condenser.

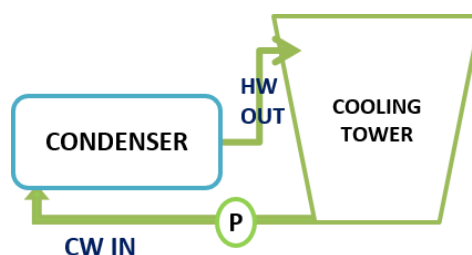

In a steam power plant, Steam is generated in a boiler, expanded in the prime mover and condensed in the condenser and fed into the boiler again. The layout of steam power plant is given below.

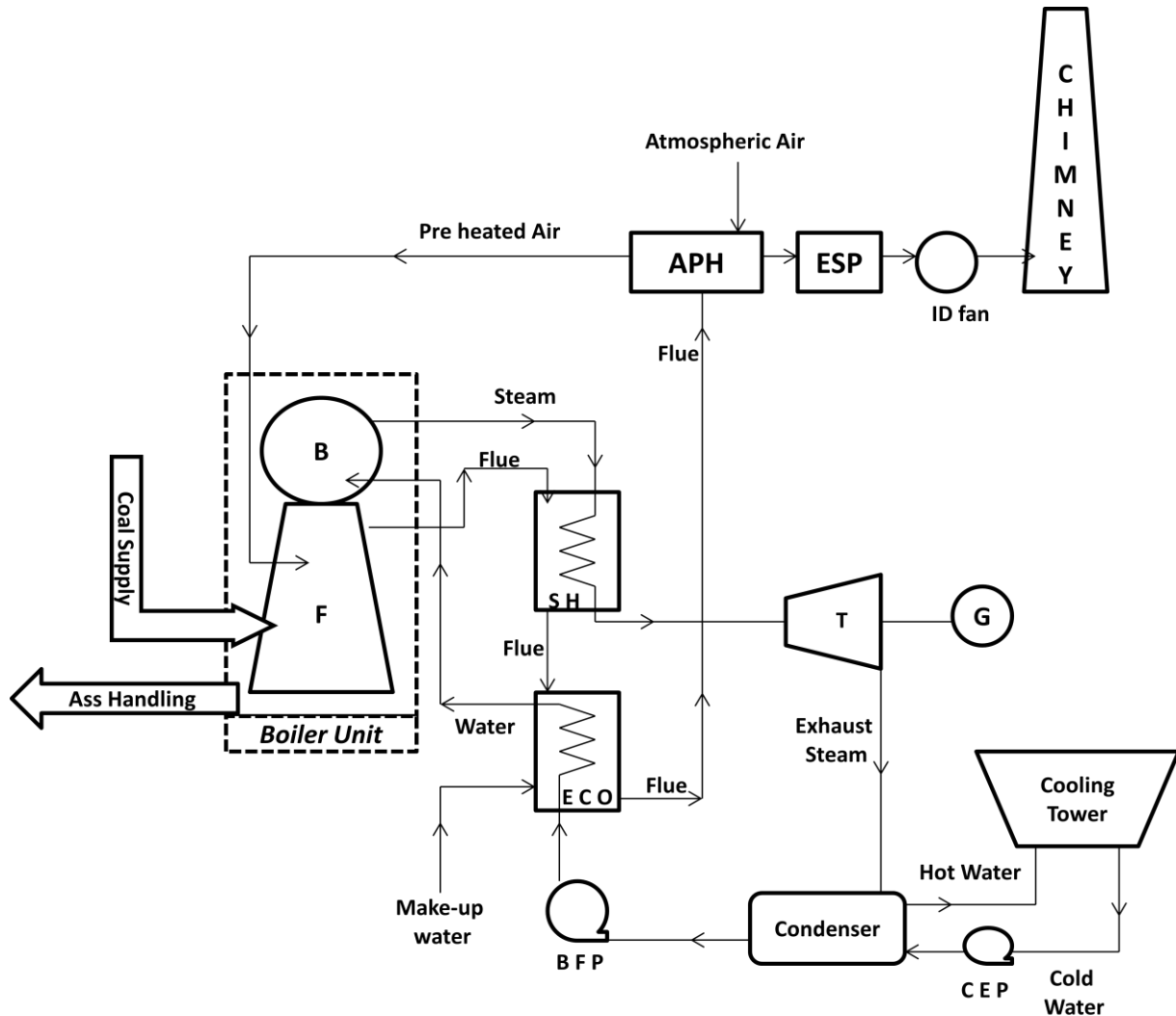

Carnot vapour power cycle:

The P-V and T-s diagram for Carnot vapor cycle is shown below.

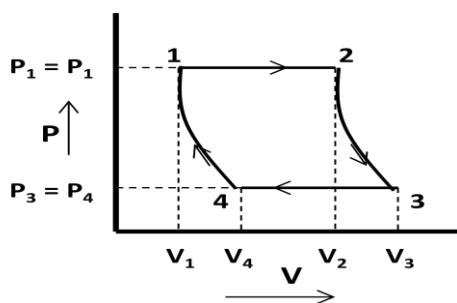

(P-V diagram)

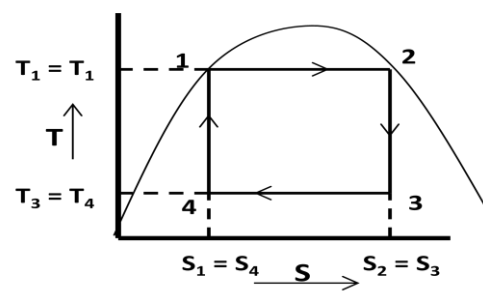

(T-s diagram)

Carnot vapor cycle consists of the four processes as described below.

- **Isothermal expansion:**

In figure process 1-2 shows the isothermal expansion process. In this process water gets heated in the boiler at constant temperature ($T_1 = T_2$) and pressure ($P_1 = P_2$) and gets converted into steam. Entropy increases from s_1 to s_2 and dry steam is collected at state 2.

Heat absorbed by water (Q_{1-2}) = $T_1 (s_2 - s_1)$

- **Reversible adiabatic expansion:**

In figure process 2-3 shows the reversible adiabatic expansion process. In this process steam expands inside the turbine at constant entropy ($s_1 = s_2$) and produce shaft power. Steam becomes wet at state 3. Pressure and temperature get changed from state 2-3.

- **Isothermal compression:**

In figure process 3-4 shows the isothermal compression process. In this process steam gets condensed in the condenser at constant temperature ($T_3 = T_4$) and pressure ($P_3 = P_4$). Entropy decreases from s_3 to s_4 and wet steam is collected at state 3.

Heat rejected from steam ($Q_{3-4} = T_3 (s_3 - s_4) = T_3 (s_2 - s_1)$)

- **Reversible adiabatic compression:**

In figure process 4-1 shows the reversible adiabatic compression process. In this process wet steam at state 4 gets compressed to state 1 at constant entropy ($s_4 = s_1$) in feed pump. Pressure and Temperature get changed from state 4-1.

Efficiency of Carnot Cycle:

$$\begin{aligned} \text{Efficiency} = \eta_{\text{carnot}} &= \frac{\text{Workdone}}{\text{Heat Supplied}} = \frac{\text{Heat supplied} - \text{heat rejected}}{\text{Heat Supplied}} \\ &= \frac{Q_{1-2} - Q_{3-4}}{Q_{1-2}} = \frac{T_1(s_2 - s_1) - T_3(s_2 - s_1)}{T_1(s_2 - s_1)} = \frac{T_1 - T_3}{T_1} = 1 - \frac{T_3}{T_1} \end{aligned}$$

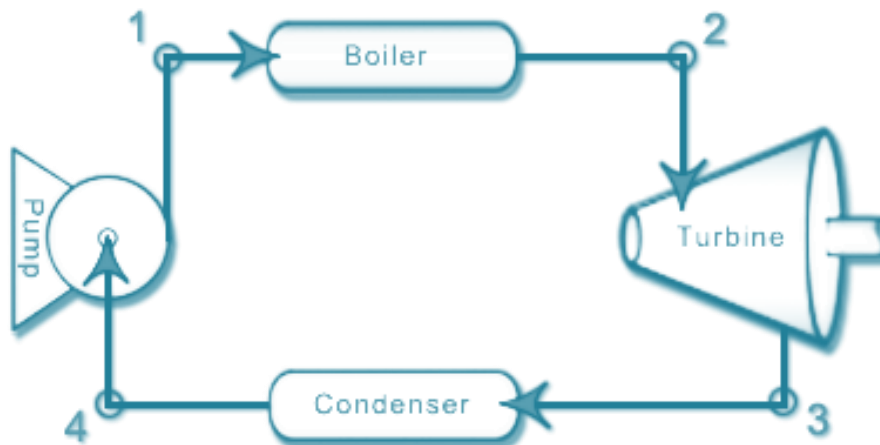

(Simple steam power plant working on Carnot cycle)

The limitations of Carnot vapor cycle are

- ♣ It is difficult to compress a wet vapor isentropically to the saturated state (process 4-1).
- ♣ It is difficult to control the quality of the condensate coming out of the condenser.
- ♣ The efficiency of the Carnot cycle is greatly affected by the temperature T_1 .
- ♣ The cycle is still more difficult to operate in practice with superheated steam.

Rankine cycle:

A steam power plant using steam as working substance works basically on Rankine cycle.

The T-S diagram for Rankine cycle is shown below.

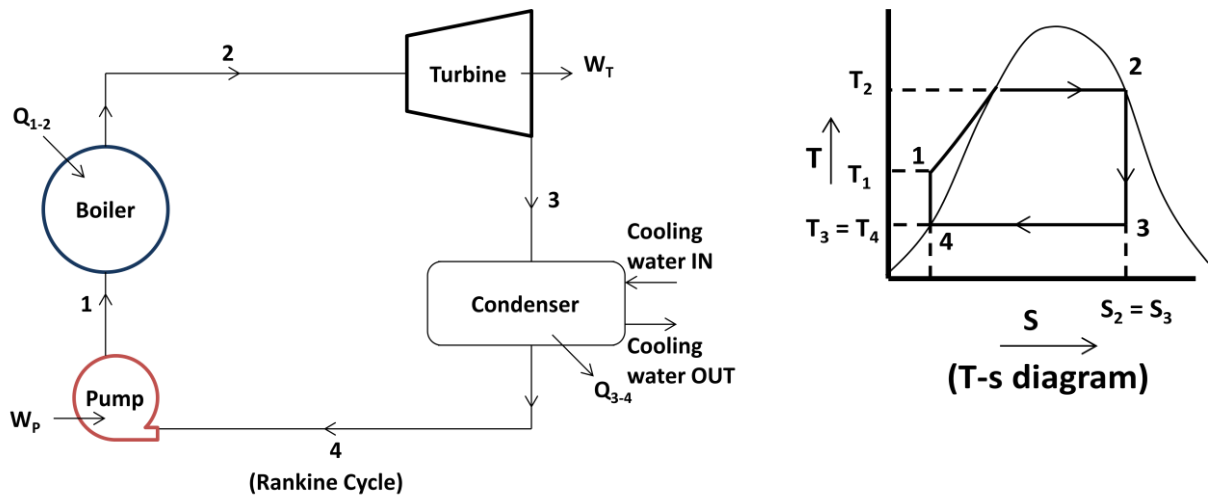

Rankine cycle consists of the four processes as described below.

- **Isothermal expansion:**

In figure process 1-2 shows the isothermal expansion process. In this process saturated water at state 1 is converted into dry saturated steam at state 2 in a steam boiler at constant pressure ($P_1 = P_2$). Water absorbs the latent heat of vaporization ($h_{fg1} = h_{fg2}$) and converted into dry saturated steam.

Amount of heat absorbed in process 1-2 = $h_{fg2} = h_2 - h_{f2}$ (for dry steam: $h_2 = h_{fg2} + h_{f2}$)

- **Reversible adiabatic or Isentropic expansion process:**

In figure process 2-3 shows the reversible adiabatic or isentropic expansion process. In this process dry saturated steam at state 2 expands isentropically in turbine to state 3. Steam at state 3 is wet.

Work done in the process 2-3 = Turbine work = $h_2 - h_3$

- **Isothermal compression process:**

In figure process 3-4 shows the isothermal compression process. In this process exhaust steam of turbine is cooled by cold water in the condenser at constant pressure ($P_3 = P_4$) and constant temperature ($T_3 = T_4$). Steam releases latent heat of vaporization and converted into saturated water.

Amount of heat rejected in process 3-4 = $h_{fg3} = h_3 - h_{f4}$

- **Reversible adiabatic or Isentropic process:**

In figure process 4-1 shows the reversible adiabatic or isentropic process. In this process saturated water is drawn by the pump and feed into the boiler.

Work done in this process 4-1 = Pump work = $h_1 - h_{f4}$

Efficiency of Rankine cycle:

$$\text{Efficiency} = \frac{\text{Net Workdone}}{\text{Heat Supplied}} = \frac{W_T - W_P}{Q_{1-2}} = \frac{(h_2 - h_3) - (h_1 - h_{f4})}{(h_2 - h_{f1})}$$

If pump work is neglected then $W_P = 0$

Various end conditions of steam:

The T-S diagram for various end conditions of steam can be discussed by the Rankine cycle.

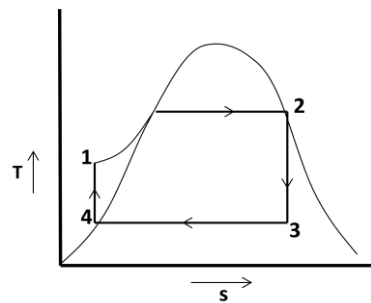

(Steam is dry at state 2)

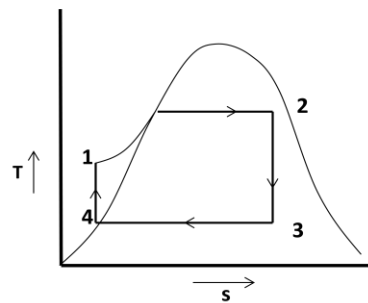

(Steam is wet at state 2)

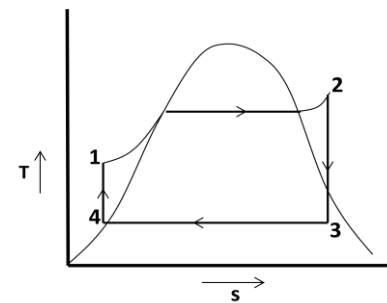

(Steam is superheated at state 2)

- **Efficiency ratio:**

It is the ratio of thermal efficiency to Rankine efficiency or actual cycle efficiency to ideal cycle efficiency.

$$\text{Efficiency ratio} = \frac{\text{Thermal efficiency}}{\text{Rankine efficiency}}$$

- **Thermal efficiency:**

$$\text{Thermal efficiency} = \frac{3600 \times P}{m(h_2 - h_{f3})}$$

Where, P = power developed in kW and

m = mass of steam supplied

- **Work ratio:**

It is the ratio of net work done to the turbine work.

$$\text{Work ratio} = \frac{\text{Turbine work} - \text{Compressor work}}{\text{Turbine work}}$$

- **Specific steam consumption:**

It is defined as the mass of steam supplied to the turbine to develop unit power output. It is also known as steam rate or specific rate of flow of steam.

$$\text{Specific steam consumption} = \frac{3600}{h_2 - h_3} \text{ kg/kWh}$$

Problems:

- Q.1) In a steam power cycle, the steam supply is at 15 bar and dry and saturated. The condenser pressure is 0.4 bar. Calculate the Carnot and Rankine efficiencies of the cycle. Neglect pump work.
- Q.2) A simple Rankine cycle works between pressures 28 bar and 0.06 bar, the initial condition of steam being dry saturated. Calculate the cycle efficiency, work ratio and specific steam consumption.
- Q.3) A steam turbine receives steam at 15 bar and 350°C and exhausts to the condenser at 0.6 bar. For the ideal Rankine cycle operating between these two limits, determine the (i) heat supplied, (ii) heat rejected, (iii) net work done (iv) thermal efficiency.
- Q.4) Steam at 50 bar and 400°C expands in a Rankine cycle to 0.5 bar. For a mass flow rate of 150 kg/s of steam determine (i) power developed, (ii) thermal efficiency, (iii) specific steam consumption.
- Q.5) Dry and saturated steam at 15 bar is supplied to a steam turbine working in Rankine cycle. The exhaust takes place at 1 bar. Calculate (i) Rankine efficiency, (ii) steam consumption per kWh if the efficiency ratio is 0.65.
- Q.6) A turbine working on a Rankine cycle is supplied with dry saturated steam at 25 bar and exhaust takes place at 0.2 bar. For a steam flow rate of 10 kg/s, estimate – (i) quality of steam at the end of expansion, (ii) turbine shaft work, (iii) power required to drive the pump, (iv) work ratio, (v) Rankine efficiency, (vi) heat flow in condenser.

Boiler Accessories:

Boiler accessories are the set of devices that are used to increase the efficiency of the boiler. These devices improve the boiler operation.

The following are some of the accessories which are used in boiler.

- **Air pre heater:**

- It is a heat exchanger which converts the cold air into hot air from the heat exchange between atmospheric air and flue gas.
- It recovers heat from the flue gas coming out of the Economizer.
- It is installed between the economiser and the chimney.
- The air required for the purpose of combustion is drawn through the air preheater where its temperature is raised. It is then passed through ducts to the furnace.
- The preheated air gives higher furnace temperature which results in more heat transfer to the water and thus increases the evaporative capacity per kg of fuel. It increases the boiler efficiency.

- **Economizer:**

- It is a heat exchanger which converts the cold water into hot water from the heat exchange between feed water and flue gas.
- It recovers heat from the flue gas coming out of the superheater.
- It improves the economy of the steam boiler.

- **Super heater:**

- It is a heat exchanger which converts the steam coming from the boiler into superheated steam from the heat exchange between steam and flue gas.
- It recovers heat from the flue gas coming out of boiler.
- Its purpose is to increase the temperature of saturated steam without raising its pressure. It is generally an integral part of a boiler which is located in the path of hot flue gases from the furnace.

- **Electrostatic precipitator:**

- It uses electrostatic forces to separate dust particles from exhaust gases.
- The contaminated exhaust gas flow through the passage formed by a number of high-voltage, direct-current discharge electrodes and grounded collecting electrodes.
- The airborne particles receive negative charge while passing through the ionized field between the discharge and collecting electrodes.
- These charged particles get attracted towards the positively charged grounded or collecting electrode and adhere to it.
- The collected material on the collecting electrodes is removed by rapping or vibrating the collecting electrodes.

Need of boiler mountings:

Boiler mountings are the set of safety devices installed on the boiler for its safe operation. These are very essential for a boiler to operate it safely.

The following are some of the mountings which are used in boiler.

- *Pressure Gauge*: It is used to measure the pressure of steam inside the boiler.
- *Water level Indicator*: It is used to indicate the water level in the boiler.
- *Safety Valve*: It is used to blows off the excess steam when steam pressure reaches above safety level.
- *Steam Stop Valve*: It is used to stop the steam in the boiler and transfer steam when it is required.
- *Blow off Valve*: It is used to blow off the impurities or sediments settled down in the boiler.
- *Feed check Valve*: It is used to control the flow of water from feed pump to the boiler.

Operation of boiler:

- The boiler is a closed vessel. The basic function of boiler is to convert water into steam. Water is supplied into the boiler drum where it is heated by hot gases that are formed by burning fuel in the furnace. When the steam at required pressure is generated inside the boiler, the steam stop valve releases the steam. This steam is superheated in a superheater before it is supplied into the turbine.
- The various mountings and accessories of boiler helps to run the boiler safely and to improve plant efficiency respectively.

Draught systems:

- Boiler draught is the pressure difference between absolute gas pressure within a furnace or chimney and atmospheric pressure which causes the flow of gas.
- Draught can be obtained by the use of chimney, fan, steam or air jet or a combination of these.
- Boiler Draught provide an adequate supply of air for fuel combustion. It can throw out the exhaust gases of combustion from the combustion chamber. It can discharge flue gases to the atmosphere through the chimney.
- The draughts may be classified as Natural Draught and Artificial Draught.

Natural Draught:

- When the draught is produced with the help of chimney only, it is known as Natural Draught.
- Natural draught system employs a tall chimney and don't require any external power for producing draught.

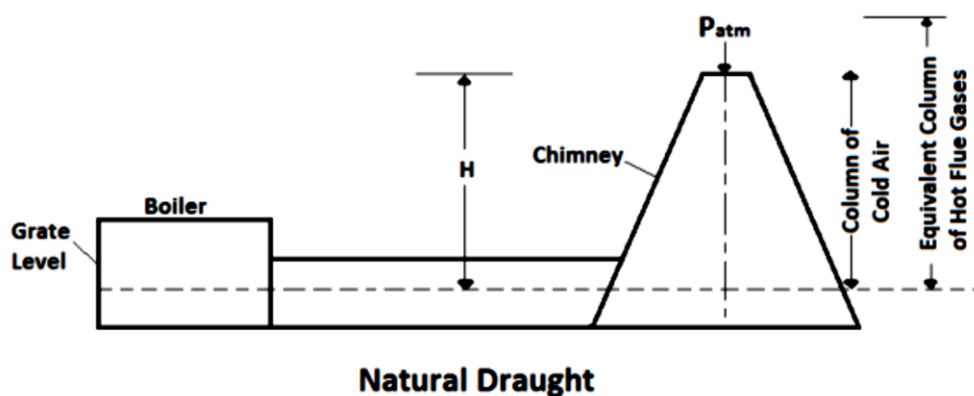

- **Advantages of Natural Draught**

- It is produced with the help of chimney only. It does not require any external power for producing the draught.
- It has low capital and maintenance cost.
- Simple in design and construction.
- It has a long life. It leaves the flue gas at a high level.

- **Disadvantages of Natural Draught**

- Maximum pressure available for producing draught by the chimney is less.
- The available draught decreased with increase in outside air temperature.
- Flue gases have to be discharged at high temperature which lowers the plant overall efficiency.

Artificial Draught:

- When the draught is produced by any other means except chimney it is known as Artificial Draught.
- To meet the high draught demand, artificial draught system is used which is classified as steam jet draught and mechanical draught.

Mechanical Draught:

- It is an artificial draught where draught is produced by the help of fans or blowers.
- It is more economical and its control is easy,
- It increases the rate of combustion by which low-grade fuel can also be used.
- It reduces fuel consumption and makes boiler operation cheaper.
- It can be classified as Forced draught, Induced draught and Balanced draught.

Forced draught:

- In this type of draught, a blower known as forced draught fan (FD fan) is placed before the grate. It forces the air into the grate through the closed ash pit. Air is forced to flow through the entire system under pressure.

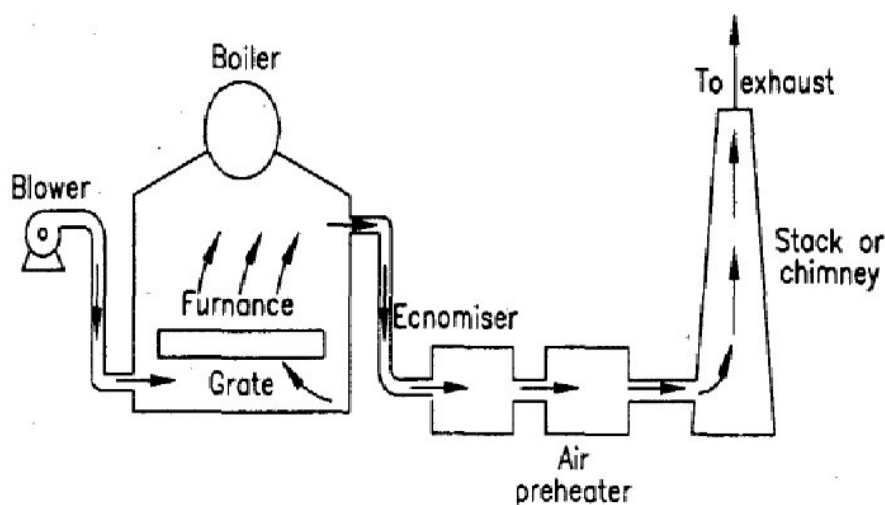

Induced draught:

- In this type of draught, a centrifugal fan known as induced draught fan (ID fan) is placed near the base of the chimney. The ID fan draws the furnace flue gas and forces the gas up through the chimney. Its action is similar to that of the natural draught.

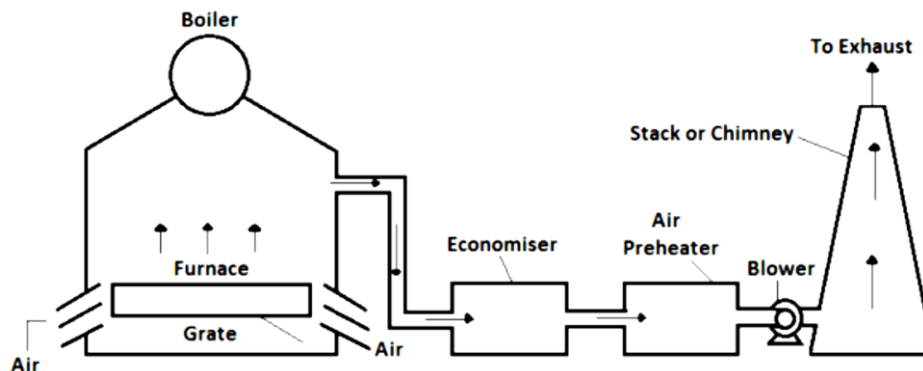

Balanced draught:

- Balanced draught is the combination of forced draught and induced draught.
- It overcomes the difficulties that are seen by using the forced draught or induced draught alone. It maintains the balance.
- The forced draught fan supplies the combustion air for better combustion of fuel and overcomes the resistance of fuel bed.
- The induced draught removes the flue gas and excess air from the furnace and helps to release it through chimney. It helps to maintain the pressure inside the furnace below atmospheric.
- If the forced draught is applied alone, there will be high pressure in the furnace. It causes difficulties in lightening and inspecting the boiler. There is possibility of blowing out of fire from the furnace which may disable the furnace work.
- If the induced draught is used alone, there will be difficulties in inspecting the boiler because cold air may rush into the furnace as the pressure inside the furnace is under atmospheric pressure.

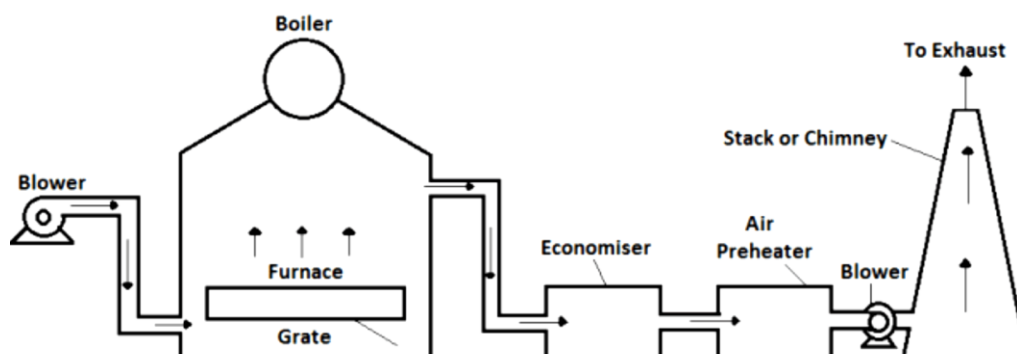

Advantages of Artificial or Mechanical Draught

- It increases the rate of combustion for which low-grade fuel can be used in the furnace. So, fuel cost is reduced.
- The desired value of draught can be produced, which is not obtained in natural draught.
- It reduces the smoke level and reduces the height of chimney.
- It is more economical and its control is easy.
- It saves the energy. It improves plant efficiency as maximum heat can be utilized.
- It reduces fuel consumption and makes boiler operation cheaper.

Disadvantages of Artificial or Mechanical Draught:

- The initial cost is high.
- The running cost is also high due to consumption of electricity but it is compensated by other savings.
- Fans and blowers produce noise.

Steam prime movers or Steam Turbine:

The steam turbine is used to convert the thermal energy of steam into mechanical energy by means of rotation of turbine shaft. This mechanical energy is used by generator to produce electrical energy.

The steam coming from the boiler rotates the turbine runner when strikes on it. Thus, mechanical energy is produced due to rotation of shaft of the turbine. When the turbine shaft rotates, the generator shaft coupled to the turbine shaft is also rotated.

Advantages of steam turbine:

- It has higher thermal efficiency.
- It can provide a good range of uniform brake horse power.
- It is properly balanced and so, vibration problem is minimised.
- It gives high rpm.
- It is reliable and durable.
- It needs no lubrication.

Disadvantages of steam turbine:

- It is less responsive to changes in power demand compared to reciprocating engines and gas turbines.
- It takes long start up time compared to reciprocating engines and gas turbines.
- It is less efficient at part load conditions than reciprocating engines and gas turbines.

Classification of steam turbine:

The steam turbines may be classified into the following types:

- According to the mode of steam action
 - Impulse turbine
 - Reaction turbine
- According to the direction of steam flow
 - Axial flow turbine
 - Radial flow turbine.
- According to the exhaust condition of steam
 - Condensing turbine
 - Non-considering turbine
- According to the pressure of steam
 - High pressure turbine
 - Medium pressure turbine
 - Low pressure turbine
- According to the number of stages
 - Single stage turbine
 - Multi stage turbine

Elements of steam turbine:

The components of steam turbine are

- **Steam Chest and Casing:**
 - The casing contains the rotor and nozzles through which the steam is expanded.
 - The steam chest is connected with the higher pressure and low-pressure steam lines.
 - The steam chest and casing protect the turbine from surrounding.
 - It encloses the steam inside the turbine.
- **Nozzles:**
 - These are used to increase the kinetic energy of steam.
- **Rotor:**
 - The rotor consists of disc mounted on a shaft. Number of blades are mounted on the periphery of the disc.
 - The shaft extends beyond the casing. One end of the shaft is connected with the governor and other end is coupled with the shaft of the generator.
 - The main function of the rotor is to convert the thermal energy of the incoming steam into kinetic energy.
- **Blades**
 - Number of blades mounted on the periphery of the disc are used to receive the steam on it. These are used for energy conversion and pressure and velocity variation.
- **Governor**
 - It is used to maintain the mean equilibrium speed of the steam turbine.

Difference between Impulse and reaction turbine:

<u>Impulse turbine</u>	<u>Reaction turbine</u>
1. The steam flows through the nozzles and impinges on the moving blades.	1. The steam flows first through guide mechanism and then through the moving blades.
2. The steam impinges on the buckets with kinetic energy.	2. The steam glides over the moving vanes with pressure and kinetic energy.
3. The steam may or may not be admitted over the whole circumference.	3. The steam must be admitted over the whole circumference.
4. The steam pressure remains constant during its flow through the moving blades.	4. The steam pressure is reduced during its flow through the moving blades.
5. The negative velocity of steam while gliding over the blades remains constant.	5. The relative velocity of steam while gliding over the moving blades increase
6. The blades are symmetrical.	6. The blades are not symmetrical
7. The number of stages required is less for the same power developed.	7. The number of stages required is more for the same power developed.

Governing of Steam turbine:

- The function of a governor is to control the fluctuation of speed of a steam turbine.
- When the steam turbine is connected to drive an alternator, there may be variation of load. According to the load on the alternator, turbine speed fluctuates. This fluctuation can be overcome by using a governing method.
- The different governing methods are:
 - Throttle governing
 - By-pass governing
 - Nozzle governing

Throttle Governing:

- This method is very simple and less costly. This is used to reduce inlet steam pressure by throttle valve operated by governing mechanism on part loads.
- An oil relay is used to operate the throttle valve.
- When the turbine works on less than full load condition, the load on the turbine suddenly released, governor speed increases with rotor speed and sleeve moves upward. So, relay piston under oil pressure moves downward and partially closes throttle valve. Then the sleeve comes to its position when equilibrium speed is obtained.

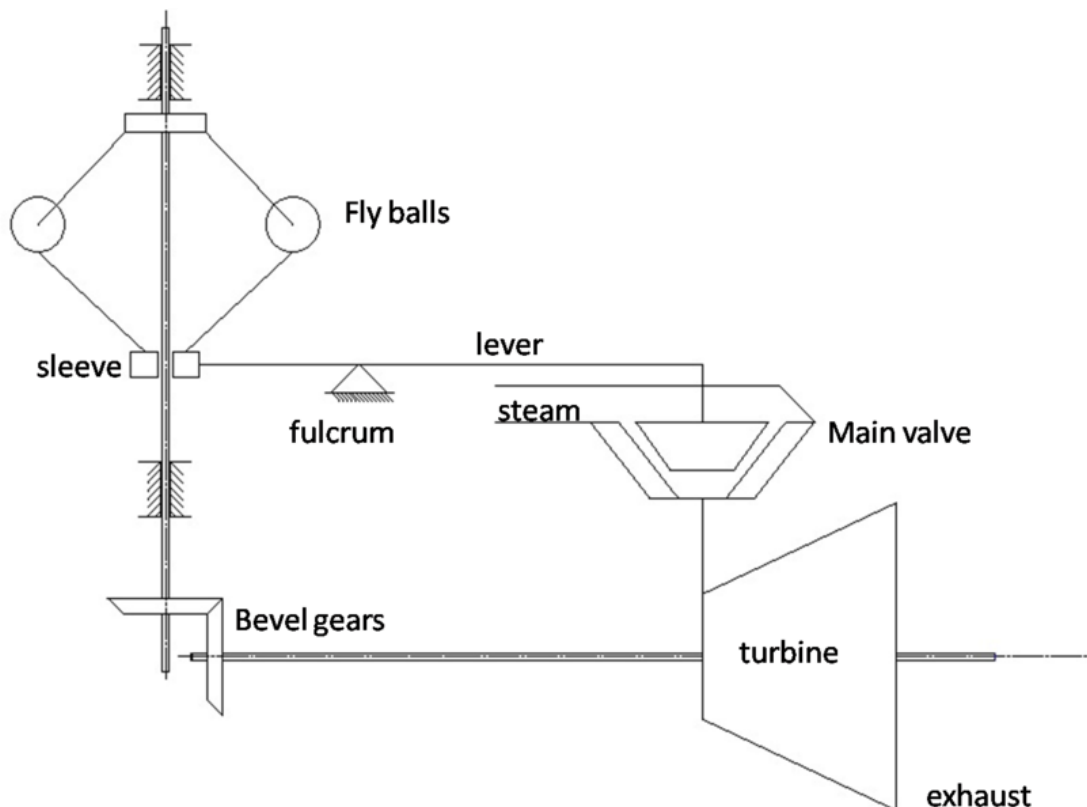

By-pass Governing:

- This method is used in modern impulse turbine operating at a very high pressure.
- In this method the whole steam enters the nozzle box through a throttle valve. This valve controls the speed of turbine for all load up to economical load. For the loads more than economical load, the by-pass valve opens and allows the steam to pass from the first stage nozzle box into steam belt and so into the fourth stage nozzle. When the load stabilizes, the valve closes.

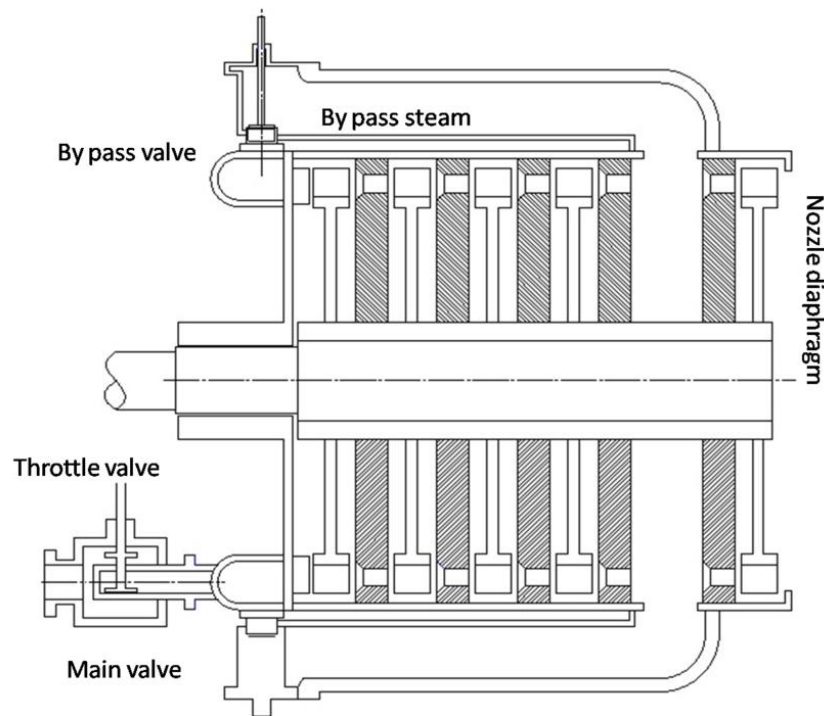

Nozzle Control Governing:

- It is basically used for part load condition.
- In this method, some set of nozzles are grouped together and steam flow to each group of the nozzle is controlled by valves. Actually, nozzle control governing is restricted to the first stage of turbine whereas the subsequent nozzle area in other stage remains constant.
- In this governing rate of steam flow is depending on the opening and closing of set of nozzles rather than regulating its pressure.

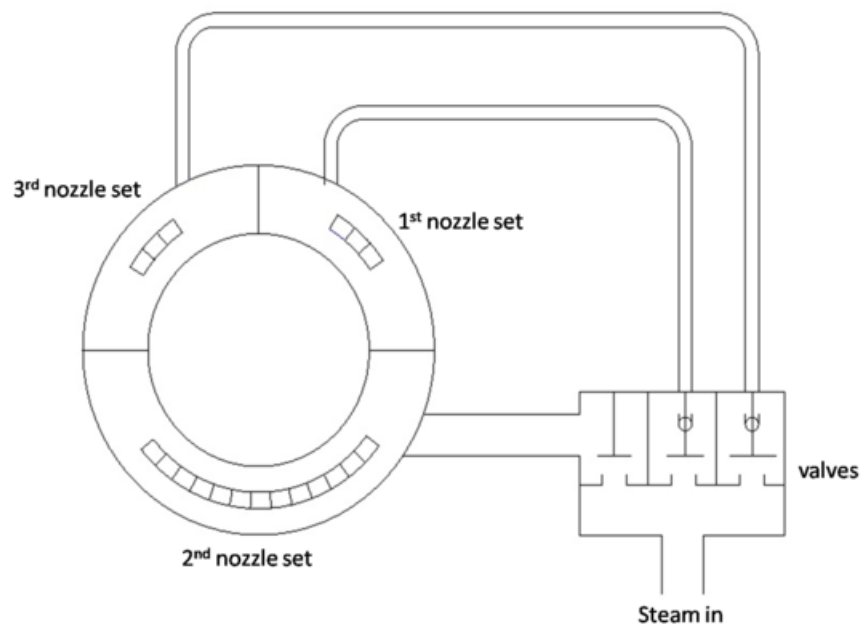

Performance of steam turbine:

- **Blade efficiency or Diagram efficiency:**

It is the ratio of the work done on the blades per kg of steam to the energy supplied to the blades per kg of steam.

Mathematically: Blade efficiency (η_b) =
$$\left(\frac{V_{w1} + V_{w2}}{\frac{V_1^2}{2}} \right) \times V_b = \left(\frac{V_{w1} + V_{w2}}{V_1^2} \right) \times 2V_b$$

- **Stage efficiency:**

It is the ratio of the work done on the blade in heat unit to the total heat energy supplied per stage.

If ΔH is the total heat energy drop in the nozzle ring, then the total energy supplied per stage is $J \times \Delta H$.

Mathematically: Stage efficiency (η_s) =
$$\frac{(V_{w1} + V_{w2})V_b}{W \cdot J \cdot \Delta H} \left(\frac{w}{g} \right) = \frac{(V_{w1} + V_{w2})}{J \cdot \Delta H} \times \left(\frac{V_b}{g} \right)$$

- **Nozzle efficiency:**

It is the ratio between actual heat drop of steam in the nozzle and adiabatic or isentropic heat drop of steam in the nozzle.

Mathematically: Nozzle efficiency (η_N) =
$$\frac{\Delta H_{act}}{\Delta H_{th}}$$

- **Relation between efficiencies:**

Stage efficiency (η_s) = Blade efficiency (η_b) \times Nozzle efficiency (η_N)

Steam Condenser:

- A steam condenser is a closed vessel into which the steam is exhausted, and condensed after doing work in the turbine. A steam condenser has the following two objectives.
- The main object of condenser is to maintain a low pressure (below atmospheric pressure) so as to draw the maximum possible energy from steam. So, the efficiency of plant can be increased.
- It is used to supply pure feed water to the hot well, from where it is pumped back to the boiler.

Classification of Condensers:

The steam condensers may be broadly classified into the following types:

- Jet condensers or mixing type condensers
 - Parallel flow jet condenser
 - Counterflow or low-level jet condenser
 - Barometric or high-level jet condenser, and
 - Ejector condenser
- Surface condensers or non-mixing type condensers.
 - Down flow surface condenser
 - Central flow surface condenser
 - Regenerative surface condenser
 - Evaporative condenser.

Elements of Steam Condensing Plant:

A steam condensing plant consists of the following elements.

- **Condenser**
 - A condenser is the heat exchanger in which heat exchange occurs between the hot exhaust steam of turbine and cold water. It works at a low pressure.
- **Air Extraction Pump**
 - It is used to maintain the vacuum pressure inside of the condenser.
- **Condensate Extraction Pump**
 - It is a low-pressure pump which is used to remove the condensed from the condenser and to supply it into the hot well.
- **Cooling Water Circulating Pump**
 - It is used to circulate the cooling water from cooling tower to condenser.
- **Hot Well**
 - It is a tank which stores the condensate which comes from the condenser.
- **Cooling Tower**
 - It is a heat exchanger in which hot water extracted from the condenser transfers heat to the cold atmospheric air and gets converted into cold water. This cold water is supplied into the condenser by cooling water pump to remove heat from steam. Some amount of water gets vaporized in the cooling tower.
- **Boiler Feed Pump**
 - It is a pump which is used to supply the water from hot well to the boiler.
- **Makeup Water Pump**
 - When there is deficiency of cooling water, makeup water needs to be added by the help of the makeup water pump to deliver fresh water from a sump to the condensing plant.

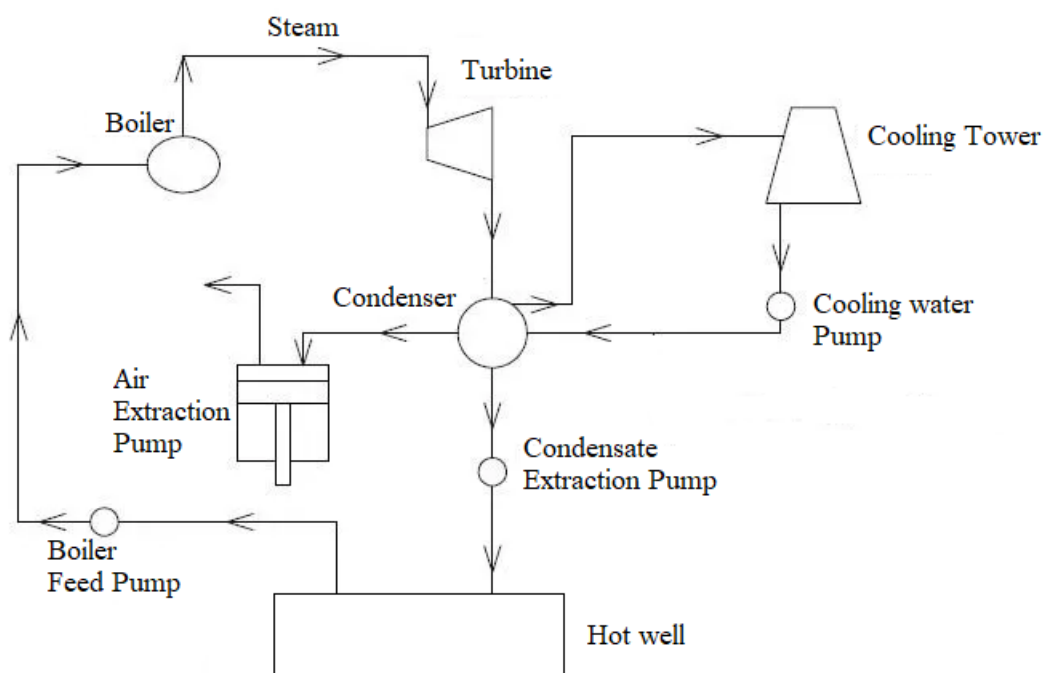

Cooling Tower:

- Cooling tower is used to reject heat into the atmosphere.
- The cold water exits from the cooling tower is sent into the condenser. This water is converted into hot water after receiving heat from the steam inside the condenser. Hot water is extracted from the condenser and supplied to the cooling tower where it is cooled by the atmospheric air.

Types of cooling tower:

Cooling towers can be classified on the basis of method of air circulation. Such as:

- Natural draught cooling tower
- Mechanical draught cooling tower
 - Forced draught cooling tower
 - Induced draught cooling tower

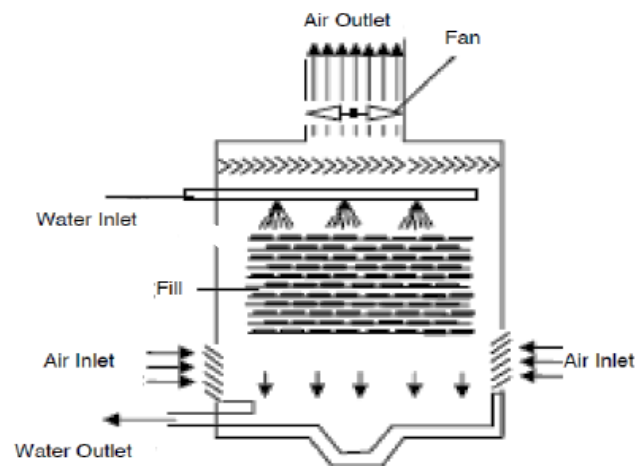

Spray pond:

- A spray pond is a reservoir in which warmed water is cooled before reuse by spraying the warm water with nozzles into the cooler air.
- In spray type cooling method, a large surface of water is exposed for evaporation.
- The hot water extracted from the condenser is supplied to the surface of the cooling tank and is projected into thin horizontal sheets. Nozzles are fitted on the sheets. These nozzles brake up the water into drops. Water droplets gets cooled due to conduction and convection. Cold water is collected at the bottom of the tank.

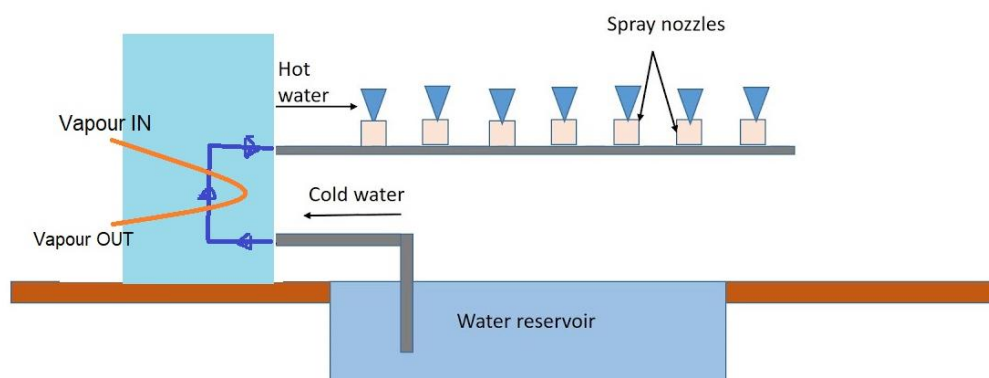

List of thermal power plants in Odisha:

Sl.No.	Name of the Plant	Capacity in MW
1.	Jindal Steel and Power Ltd	810
2.	NALCO Ltd., Captive Power Plant	1200
3.	GMR Energy	1050
4.	Vedanta Ltd., IPP and CPP	2400 and 1215
5.	Talcher Super Thermal Power Station	3000
6.	Jindal India Thermal Power Ltd	1200
7.	Rourkela Steel Plant (CPP-I)	100
8.	Thermal Power Station (OPGC	420
9.	HINDALCO Industries Ltd (CPP),	467
10.	TATA Bhushan Power & Steel Ltd.	370

Site Selection for thermal power plants:

The following points should be taken into consideration while selecting the site for a steam power station.

- Availability of raw material
- Nature of land
- Cost of land
- Availability of water
- Transport facilities
- Ash disposal facilities
- Availability of labour
- Size of the plant
- Load centre
- Public problem
- Future extension

REFERENCE

1. Power Plant Engineering by R.K. Rajput
2. Power Plant Engineering by K.K. Ramalingam
3. <https://www.mapsofindia.com/energy/>
4. <https://youtu.be/nn0yj9Ckz5s>
5. <https://youtu.be/Ec9kXfrZaR4>
6. <https://youtu.be/5RDlnPRJWZU>
7. https://youtu.be/whv4Nt4Y4AY?list=PLLy_2iUCG87BT8H9uMufjrcPF5e6Qd2bz
8. https://youtu.be/dLe36eyO1mk?list=PLLy_2iUCG87BT8H9uMufjrcPF5e6Qd2bz
9. <https://youtu.be/lKBqTOgOQTM>
10. <https://youtu.be/2zpjqv6RAX4>
11. <https://youtu.be/DFDyzREVK-Y>
12. <https://youtu.be/gE2Pz8dr6sY>
13. <https://youtu.be/uulD0KVkmWg>
14. https://youtu.be/8Ns8KXZE_bQ
15. <https://youtu.be/fw8Jfoif1BM>
16. <https://youtu.be/9RhMfmDXCko>
17. <https://youtu.be/889l0bq0pCY>
18. https://www.youtube.com/playlist?list=PLrBOEAbqIXUwktw8ybEaKgO4_XpnYDSS3
19. <https://youtu.be/tpigNNTQix8>
20. <https://youtu.be/c9tBOjny28>

NUCLEAR POWER STATION

A power plant that uses nuclear reactor as heat source is known as nuclear power plant. Nuclear power is a clean and efficient way for producing steam from water. The steam produced is used to turn the turbine to develop mechanical power, which can be used by the generator to produce electricity.

Nuclear power plants use low enriched uranium fuel to produce electricity through a process called fission—the splitting of uranium atoms in a nuclear reactor.

Nuclear Fuel:

Nuclear fuel should be fissionable material. It can be defined as an element or isotope that undergo nuclear fission to produce chain reaction by means of bombardment of neutrons to the nucleus of heavy atoms. Examples of some important nuclear fuels are U233, U235 and Pu239.

Some materials are not fissionable by themselves. These can be converted into fissionable material by means of nuclear reaction. These materials are known as *fertile materials*. These are converted into fissile material before undergo fission reaction. Some materials can undergo fission reactions directly. These are known as *fissile materials*. The process of transmutation of fertile materials into fissile materials is referred to as *fuel breeding*. Examples of fertile material are Pu239 and U233.

U235 is most unstable material. It is capable to sustain chain reaction. It is considered as primary fuel. U233 and Pu239 are artificially produced from Th232 and U238 respectively. These are called secondary fuel.

Nuclear Fission:

Nuclear fission is the process where the nucleus of a heavy atom splits into fragments of lighter nuclei with the release of energy. It is carried out by the bombardment of neutrons to the nucleus of heavy atoms. This reaction produces energy as well as neutrons. These neutrons can be used to split other atoms further in the chain reaction.

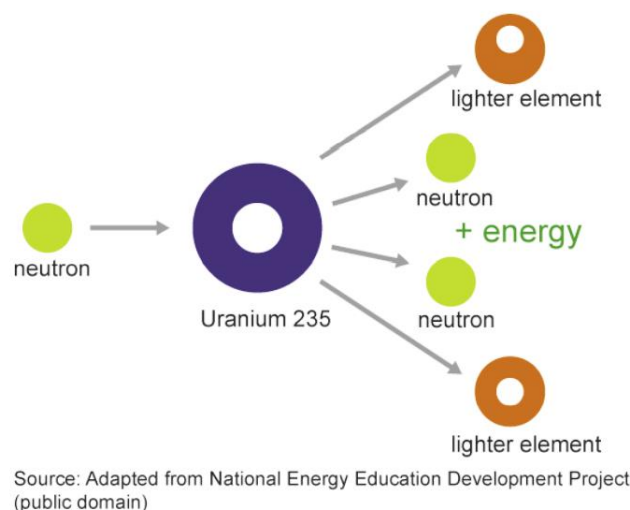

Figure: Splitting of U 235 in fission

Nuclear Fusion:

Nuclear fusion is the process where the nuclei of lighter atoms combine to form heavy nucleus with the release of energy. It produces greater energy than the fission reaction.

Difference between Nuclear Fission & Nuclear Fusion:

Nuclear Fission	Nuclear Fusion
Fission occurs when a neutron bombarded into a larger atom, forcing it to excite and split into two smaller atoms—also known as fission products. Additional neutrons are also released that can initiate a chain reaction.	Fusion occurs when two atoms collide or fuse together to form a heavier atom, like when two hydrogen atoms fuse to form one helium atom.
When each atom split, a tremendous amount of energy is released	The energy released during nuclear fusion is several times greater than the energy released during nuclear fission.
Fission reactions do not occur in nature naturally	Fusion reactions occur in stars and the sun
Little energy is needed to split an atom in a fission reaction	High energy is needed to bring fuse two or more atoms together in a fusion reaction
The energy released by fission in nuclear power plant heats water into steam. The steam is used to spin a turbine to produce carbon-free electricity.	It is not used in nuclear power plants because tremendous amount of pressure and temperature needed to join the nuclei together.

Components of a Nuclear Power Plant:

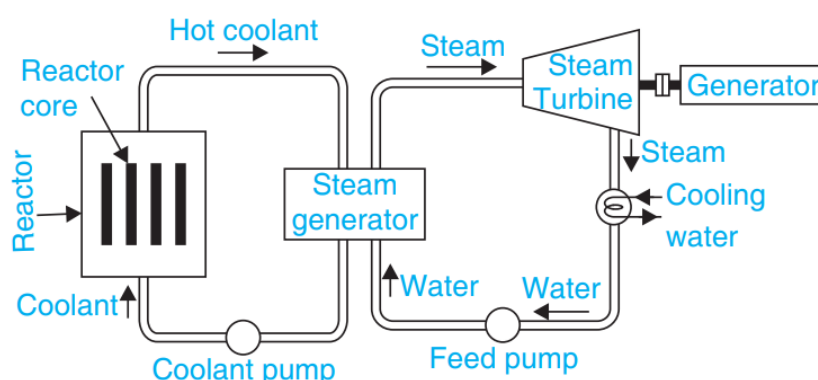

Figure: Components of Nuclear Power Plant

The main components of a nuclear power plant are:

- Nuclear reactor
- Heat exchanger (steam generator)
- Steam turbine
- Condenser
- Electric generator

In a nuclear power plant, the reactor produces heat energy from the nuclear fission of the nuclear fuel. The heat liberated in the reactor is taken up by the coolant circulating through the reactor core. Hot coolant leaves the reactor and then flows through the tubes of steam generator. Hot coolant gives up the heat energy to the feed water flowing through the steam generator. The steam so produced expands in the steam turbine and produce mechanical work. The steam turbine runs an electric generator to produce electricity. The exhaust steam can be condensed for recycling. Pumps are provided to circulate the coolant, condensate and feed water.

Nuclear Reactor:

A nuclear reactor is an apparatus in which heat is produced due to nuclear fission chain reaction.

The reactor generates spontaneous energy from the continuous fission reaction. During fission kinetic energy is converted into thermal energy. The heat produced in the reactor is transferred to a coolant which is either used directly or indirectly by converting into steam. This steam is used to rotate the turbine where the thermal energy is converted into mechanical energy.

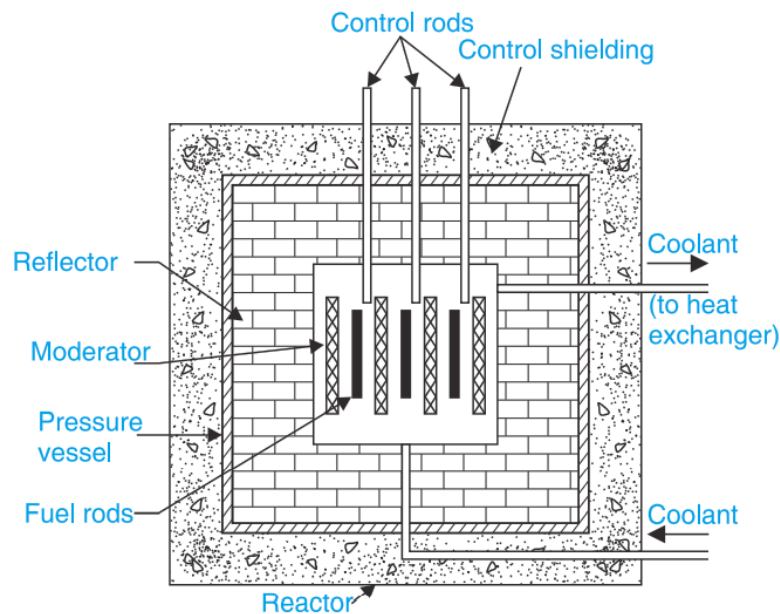

Figure: Nuclear Reactor

Main Components of a Nuclear Reactor are:

Nuclear Fuel: Commonly used nuclear fuels are U233, U235 and Pu239. Among these U235 is most unstable and is capable to sustain chain reaction. This is called as primary fuel. U233 and Pu239 are artificially produced from Th232 and U238 respectively and are called secondary fuel.

Core: It contains all the fuel and generates the heat required for energy production.

Moderator: Material in the core which slows down the neutrons released from fission so that they cause more fission. H₂O, D₂O (heavy water), He (gas), Be and C (graphite) are the commonly used moderators.

Coolant: It absorbs heat when passes through the core and delivers that heat to the heat exchanger for the formation of the steam. Commonly used coolants are Santowax R (organic, Hg, He, CO₂)

Control rods: These are made with neutrons-absorbing material like cadmium or boron. These are inserted into or withdrawn from the core to control the rate of reaction. By pushing these rods deeper into the central core, any number of excess neutrons can be absorbed.

Shielding: Shielding is necessary in order to protect the walls of the reactor vessel from radiation damage, and to protect operating personnel from exposure to radiation.

Reflector: A reflector is placed round the core to reflect back some of the neutrons that leak out from the surface of the core. It is generally made of the same material as the moderator

Reactors Vessel: It encloses the various parts inside the reactor including the core, shield, reflector etc.

Containment: The enveloping structure that separated the nuclear reactor from the surrounding environment.

Properties of Moderator:

The desirable properties of a moderator in a reactor are:

- High slowing down power.
- Low parasite capture.
- Non-corrosiveness.
- High melting point for solids and low melting point for liquids.
- Chemical and radiation stability.
- High thermal conductivity.

Properties of Coolant:

The desirable characteristics for a reactor coolant are:

- Low parasite capture.
- Low melting point.
- High boiling point.
- Chemical and radiation stability.
- Low viscosity.
- Non-toxicity.
- Non-corrosiveness.
- Minimum induced activity.
- High specific heat.
- High density.

Difference between Nuclear and Thermal Power Plant:

Nuclear Power Plant	Thermal Power Plant
It needs less space.	It needs more space.
Uses nuclear fission of radioactive fuels to produce heat energy. This energy is used to produce steam.	Uses coal, oil or gases to produce heat energy. This energy is used to produce steam.
These plants are located away from populated area to avoid the risk of radioactive pollution.	These plants are installed where there is suitability of supply of fuel, water and transport.
It has high initial cost in comparison to thermal power plants.	It has low initial cost in comparison to nuclear power plants.
It has low operating cost in comparison to thermal power plants.	It has high operating cost in comparison to nuclear power plants.
Coal is the source of power. Fuel source is limited.	Nuclear fuels like Uranium are the sources of power. Fuels are available sufficiently.
Overall efficiency is more.	Overall efficiency is less.
It takes more time for starting the plant.	It starts easily.
Standby losses are less.	Standby losses are more.
Better in environment friendly.	Least environment friendly.

Site Selection for Nuclear Power Plant:

The following factors are considered while selecting the site for a nuclear power plant.

- The site should be nearer to a river, reservoir or sea to fulfill the requirement of water for the plant.
- To minimize the power loss in transmission lines and to reduce the cost of power delivered to the consumer, the plant should be located nearer to the load centre.
- The power plant should be located far away from populated area to avoid the radioactive hazard.
- The power plant should have easy accessibility through rail and road transportation facilities.
- The wastes of a nuclear power plant are radioactive and there should be sufficient space near the plant site for the disposal of wastes.
- There should be considerably no risk of disaster.
- The site should be safe as per geological, hydrological, meteorological and seismological report for the location.

Radioactive waste disposal:

Radioactive waste contains radioactive material. It is usually a byproduct of nuclear power plant. It is hazardous to environment and living organisms, so it is regulated by government agencies in order to protect human health and the environment.

Radioactivity naturally decays over time. So isolated and confined radioactive wastes possess no threat after a sufficient time period. These wastes can be well managed for disposal. It is approached to manage radioactive waste by segregation and storage for short-lived waste, near-surface disposal for low and some intermediate level waste, and deep burial or partitioning / transmutation for the high- level waste.

List of Nuclear Power Stations:

The various nuclear power plants situated in India are as follows:

Name of the Plant	Location	Capacity
Tarapur power plant	Maharashtra	380 MW
Rana-Partap Sagar power plant	Near Kota, Rajasthan	400 MW
Kalpakkam power plant	Near Chennai, Tamil Nadu	470 MW
Narora power plant	Uttar Pradesh	470 MW
Kakrapar power plant	Surat district, Gujarat	470 MW

REFERENCE:

1. Fission and Fusion: What is the Difference? | Department of Energy
2. A text book of Power Plant Engineering by Er. R.K. Rajput, Laxmi Publication
3. Nuclear power in India - Wikipedia
4. <https://youtu.be/oPZrUW9GQRg>
5. <https://youtu.be/FFAKGyBNc04>
6. <https://youtu.be/EXFJoU1hvY0>
7. <https://youtu.be/GNfxPvzhCQw>
8. <https://youtu.be/Mhyet03VyBM>
9. <https://youtu.be/8szrOyJzq2E>

DIESEL ELECTRIC POWER STATION

In an engine-generator set, the generator shaft is coupled to the Engine shaft. The engine converts chemical energy in fuel into mechanical energy. The generator converts mechanical energy into electrical energy.

Diesel engine is an excellent prime mover for electric generator capacities of from 100 hp to 5000 hp. The Diesel units used for electric generation are more reliable and long - lived piece of equipment compared with other types of plants.

Diesel engine power plants are installed where:

- Supply of coal and water is not available in desired quantity.
- Power is to be generated in small quantity for emergency services.
- Standby sets are required for continuity of supply such as in hospital, telephone exchange.

Advantages of diesel electric power plants:

The advantages of diesel power plants are listed below.

- Design and installations are very simple.
- Requires less water for cooling purpose.
- Standby losses are less as compared to other Power plants.
- Low fuel cost.
- Quickly started and put on load.
- Smaller storage is needed for the fuel.
- Layout of power plant is quite simple.
- No problem of Ash handling.
- Less supervision required.
- For small capacity, diesel power plant is more efficient as compared to steam power plant.
- Able to respond to varying loads without any difficulty.
- Occupy less space.
- Requires less operating and supervising staff as compared to steam power plant.
- Overall capital cost is lesser than that of steam power plant.

Disadvantages of diesel electric power plants:

The disadvantages of diesel power plants are listed below.

- High operating cost.
- High maintenance and lubrication cost.
- Fuel cost is more, since in India diesel is costly.
- The plant cost per kW is comparatively more.
- The life of diesel power plant is small due to high maintenance.
- Noise is a serious problem in diesel powerplant.
- Diesel power plant cannot be constructed for large scale.
- These can't be constructed in large size. Its capacity is limited.
- Diesel power plant are not economical.

Applications:

- They are quite suitable for mobile power generation and are widely used in Transportation systems consisting of railroads, ships, automobiles and airplanes.
- They can be used for electrical power generation incapacitiesfrom100 to 5000 H.P.
- They can be used as standby power plants.
- They can be used as peak load plants for some other types of power plants.

Layout of diesel electric power plants:

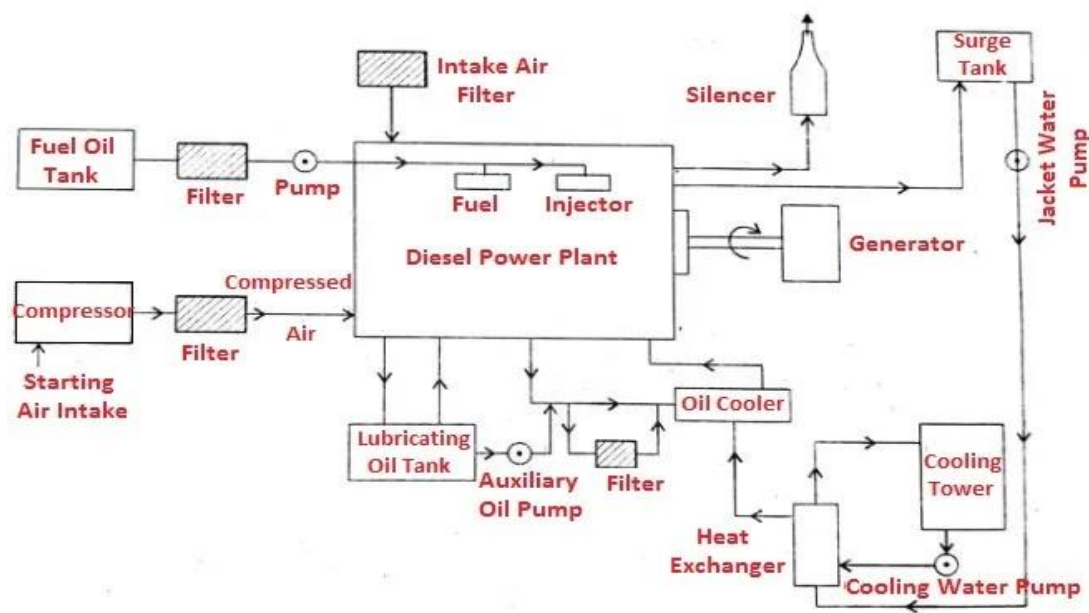

Figure-1: Schematic layout of Diesel Power Plant

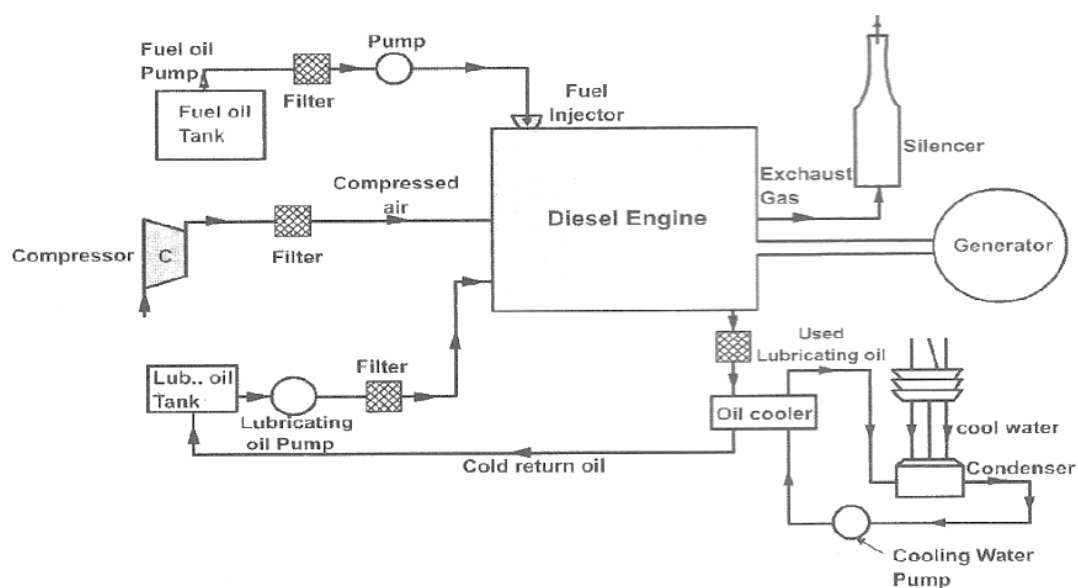

Figure-2: Schematic layout of Diesel Power Plant

Essential Component of Diesel Power Plant

- Engine
- Air intake system
- Exhaust system
- Fuel system
- Starting system
- Governing system
- Cooling system
- Lubrication system

Air Intake System:

The air intake system conveys fresh air through pipes and ducts to

- Air intake manifold of 4s engine
- Scavenging pump inlet of 2s engine
- Supercharger inlet of supercharged engine

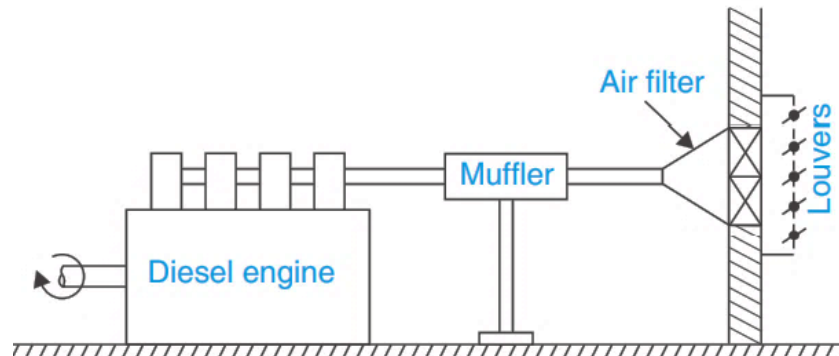

Figure: Air Intake System

The fresh air is first drawn and filtered to catch dirt from outside air. The filters may be of dry or oil bath. Filtered air is then drawn by the engine during suction.

Exhaust System:

The exhaust system is used to discharge the engine exhaust to the atmosphere outside the plant.

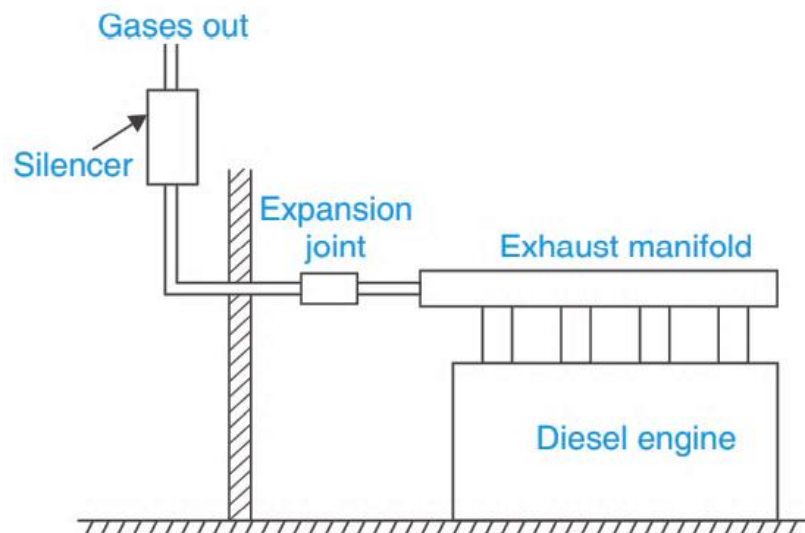

Figure: Exhaust System

The exhaust manifold takes exhaust gases from engine outlet and discharges the gases to the exhaust pipe. The muffler provided with the exhaust pipe reduces pressure in the exhaust line and reduces noise.

Fuel Supply system:

The fuel is delivered to the plant by railroad tank car, by truck or by barge and tanker and stored in the bulk storage situated outdoors for the sake of safety. From this main fuel tank, the fuel oil is transferred to the daily consumption tank by a transfer pump through a filter.

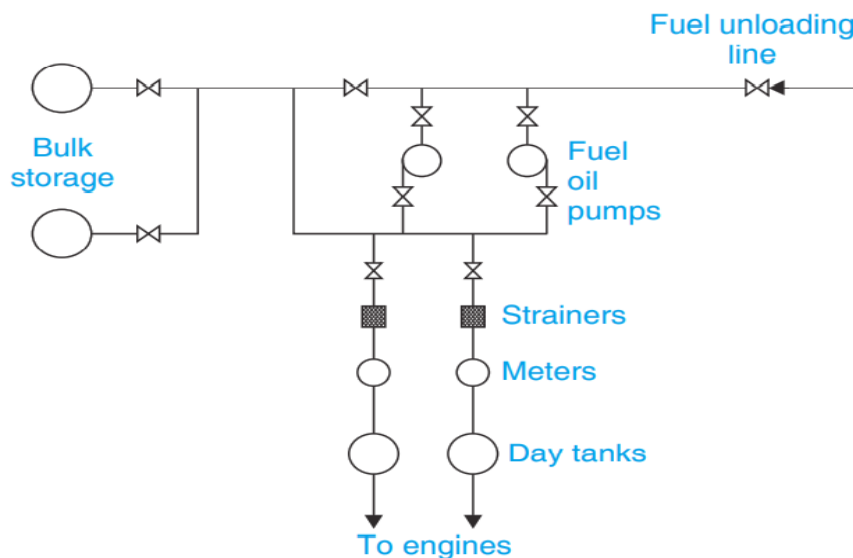

Figure: Fuel Storage & Supply System

The capacity of the daily consumption should be at least the 8-hour requirement of the plant. This tank is located either above the engine level so that the fuel flows by gravity to the injection pump or below the engine level and the fuel oil is delivered to the injection pump by a transfer pump driven from the engine shaft.

Fuel Injection system:

The five essential functions of a fuel injection system are:

- To deliver oil from the storage to the fuel injector.
- To raise the fuel pressure to the level required for atomization.
- To measure and control the amount of fuel admitted in each cycle.
- To control time of injection.
- To spray fuel into the cylinder in atomized form for thorough mixing and burning

Fuel injector is a mechanical device which is responsible for injecting the required amount of fuel into the engine to produce suitable air/fuel mixture for optimal combustion

The types of fuel injection methods are

- Common Rail
- Individual Pump Injection
- Distributor

Common Rail Fuel Injection:

In this type of injection, a pump supplies fuel under high pressure to a fuel header. This forces the fuel to each of the nozzle situated in the cylinders. A mechanically operated mechanism valve allows the fuel to enter in appropriate cylinder. The pressure relief and timing valves are used to regulate the injection time and amount. The spring-loaded safety valve used as a check valve. When injection valve lifts to admit high pressure fuel to spray valve, its needle rises against the spring. when the pressure is vented to the atmosphere, the spring shut the valve.

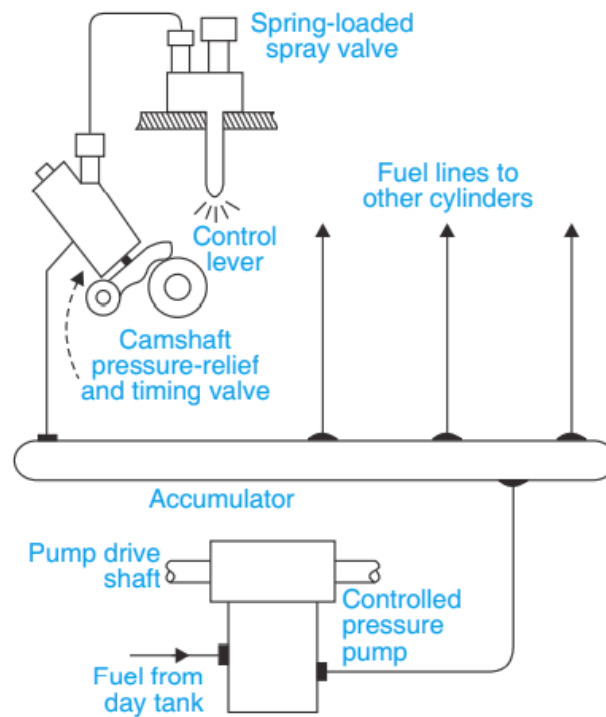

Figure: Common Rail Fuel Injection System

Individual Pump Fuel Injection:

In this type of fuel injection system each fuel nozzle is connected to a separate injection pump. The pump controls the fuel charge and injection timing. Nozzles contain a delivery valve actuated by the fuel-oil pressure.

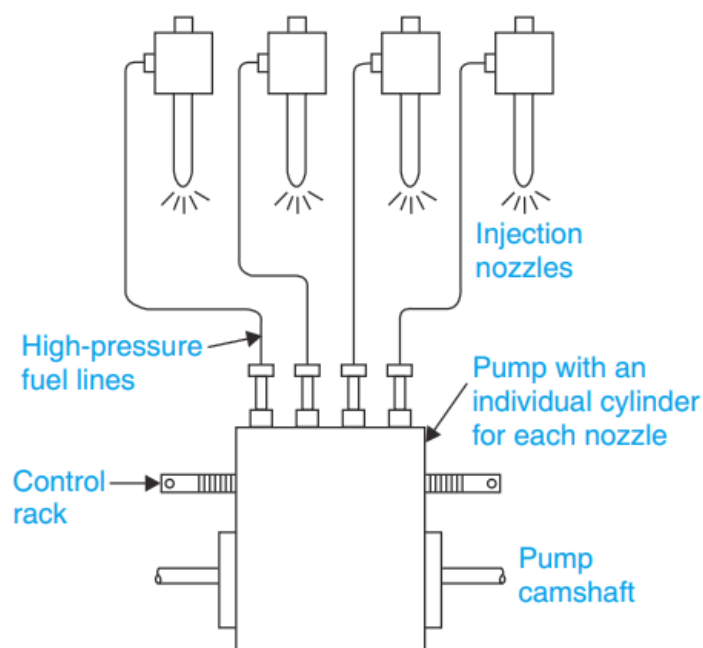

Figure: Individual Pump Fuel Injection System

Distributor System:

In this type of fuel injection system, the fuel is metered at a central point. The pump meters the fuel and time the injection. The pressurized fuel distributes to cylinders in correct firing order by cam operated poppet valves which open to admit fuel to the nozzles.

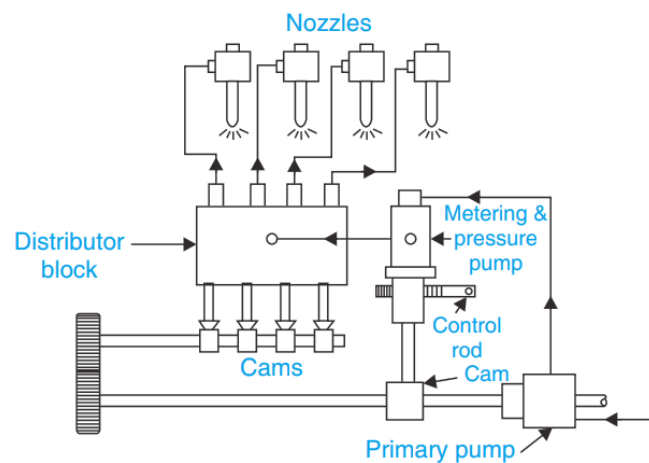

Figure: Distributor Fuel Injection System

Cooling System:

During the combustion process the peak gas temperature in the cylinder of an internal combustion engine is of the order of 2500 K. Metallic components are heated with very high temperature. Thus, cooling for the cylinder head, cylinder and piston is necessary.

Cooling of the engine reduce the possibility of fatigue cracking, knocking and preignition problem and increases the thermal efficiency.

Based on cooling medium two types of cooling system are generally used. These are

- Air as direct cooling system
- Liquid or indirect cooling system

Air cooling is used in small engine and portable engines. Liquid cooling is used in case of big engines.

The cooling system can also be classified into two types:

- *Open Cooling System:* A Plant near the river may utilize the river water for cooling & discharging again the hot water into river. This type of cooling system is known as open cooling system.
- *Closed Cooling System:* The Cooling Water is circulated again & again and only water lost due to leakage, evaporation etc. is made up by taking make up water from supply source.

Liquid cooling system is further classified as:

- Open cooling system
- Natural circulation (Thermo-system)
- Forced circulation system
- Evaporation cooling system

Open Cooling System:

This system is applicable only where plenty of water is available. The water from the storage tank is directly supplied through an inlet valve to the engine cooling water jacket. The hot water coming out of the engine is not cooled for reuse but it is discharged.

Natural circulation (Thermo-system)

The system is closed and designed so that the water may circulate naturally because of the difference in density of water at different temperatures. When the water is heated, its density decreases and it tends to rise, while the colder molecules tend to sink. Circulation of water then is obtained as the water heated to rise and the water-cooled in the radiator with the help of air passing over the radiator either by a fan.

Forced circulation system

Forced circulation cooling system that is closed one. The coolant (water or synthetic coolant) is circulated through the cylinder jacket with the help of a pump and driven by the engine.

Evaporation Cooling System:

In this method, water gets converted into steam after cooling the engine. This steam is cooled by the evaporative cooling method.

Lubrication System:

Engine lubrication system provides lubricating oil to moving parts of the engine to reduce the friction between them. It reduces the wear & tear of the engine parts.

This system consists of lubricating oil pump, oil tanks, filters, coolers, purifiers & connecting pipes.

In this system the lubricating oil is stored in main lubricating oil tank. From this tank, oil is drawn by means of oil pump and then passed through the oil filter for removing impurities. Then this clean lubricating oil is delivered to the different points of the engine where lubrication is required. The oil cooler is provided in the system to keep the temperature of the lubricating oil as low as possible. It is then cooled through heat exchanger by means of cold water and then it is fed to the engine.

The main function of the lubricant is:

- To reduce friction and wear between the parts having relative motion.
- To clean the surface by carrying away the carbon and metal particles caused by wear.
- To absorb shock between bearings and other parts and consequently reduce noise.
- To cool the surfaces by carrying away heat generated due to friction.
- To remove the heat generated due to friction and keeps the parts cool.

Engine lubrication system is classified as:

- Wet Sump lubrication system
 - Splash system
 - Semi pressure system
- Dry sump lubrication system
- Mist lubrication system

Starting System:

Initial rotation of the engine shaft is done by the starting system until the firing start and the engine runs with its own power. In case of small diesel generator set, the initial rotation of shaft is done by rotating the handle. But in case of large power plants, it is done by compressed air. This system includes storage compressed air tank, self-starter, auxiliary engines & electrical motors (battery) etc.

Site Selection for Plant

The following factors should be considered while selecting a site for diesel power plant.

- *Foundation subsoil conditions* - Foundation of subsoil condition at a reasonable depth provides a strong support to the engine.
- *Access to the site* - The site should be accessible for rail and road.
- *Distance from the load centre* - The location of the plant should be near to the load centre to reduce the cost of transmissions line, cost of maintenance and power load.
- *Availability of water* - Sufficient water should be available at the site.
- *Fuel transportation* - To minimize the transportation charge, the sites should be near to the source of fuel supply.

REFERENCE:

1. <https://youtu.be/fw8Jfoif1BM>
2. <https://youtu.be/9RhMfmDXCko>
3. <https://youtu.be/889I0bq0pCY>
4. https://www.youtube.com/playlist?list=PLrB0EAbqIXUwktw8ybEaKgO4_XpnYDSS3
5. https://www.researchgate.net/publication/351686362_Power_Plants_Ch_5_Diesel_Power_Plants
6. A text book of Power Plant Engineering by Er. R.K. Rajput, Laxmi Publication

HYDEL POWER STATION

Hydroelectric power is the obtained from the energy of falling water whereas hydroelectric power plant is the power plant utilising this potential energy of water at a high level for the generation of electrical energy. There is a conversion of hydraulic energy into mechanical energy followed by electrical energy.

Advantages of Hydroelectric power plants:

- Water is available throughout the year.
- Operational and maintenance cost is lower.
- The cost of fuel is nil.
- Hydro Plants are made for multiple purposes.
- The requirement of working staff is less.
- The cost of expenses is lower.
- It is a clean and non-polluting source of energy.
- No fuel is required.
- Dams are constructed near rivers. As the water level rises, the kinetic energy of water gets changed to potential energy.

Disadvantages of Hydroelectric power plants:

- Embankment construction cost is high.
- Land space requirement for set up is large.
- Water must be abundant to continue the process.
- Aquatic life is affected.
- Embankment areas need to be evacuated for flood plains.
- Highly expensive.
- Large areas of human habitation and agricultural fields are submerged.
- Dams can be made in limited areas.

General arrangement of storage type hydroelectric project

The major requirement for hydroelectric power plant is explained below.

- There must be availability of water in huge quantity at sufficient head. For this requirement construction of dam across a river or lake is required.
- The dam provides an artificial storage reservoir.
- A pressure tunnel is taken off from the reservoir to the valve house at the start of the penstock.
- The valve house contains main sluice valves for controlling water flow to the power station and automatic isolating valves for cutting off water supply in case the penstock bursts.
- A surge tank is provided just before the valve house for better regulation of water pressure in the system.
- Penstock to carry water.
- Water turbine
- Alternator

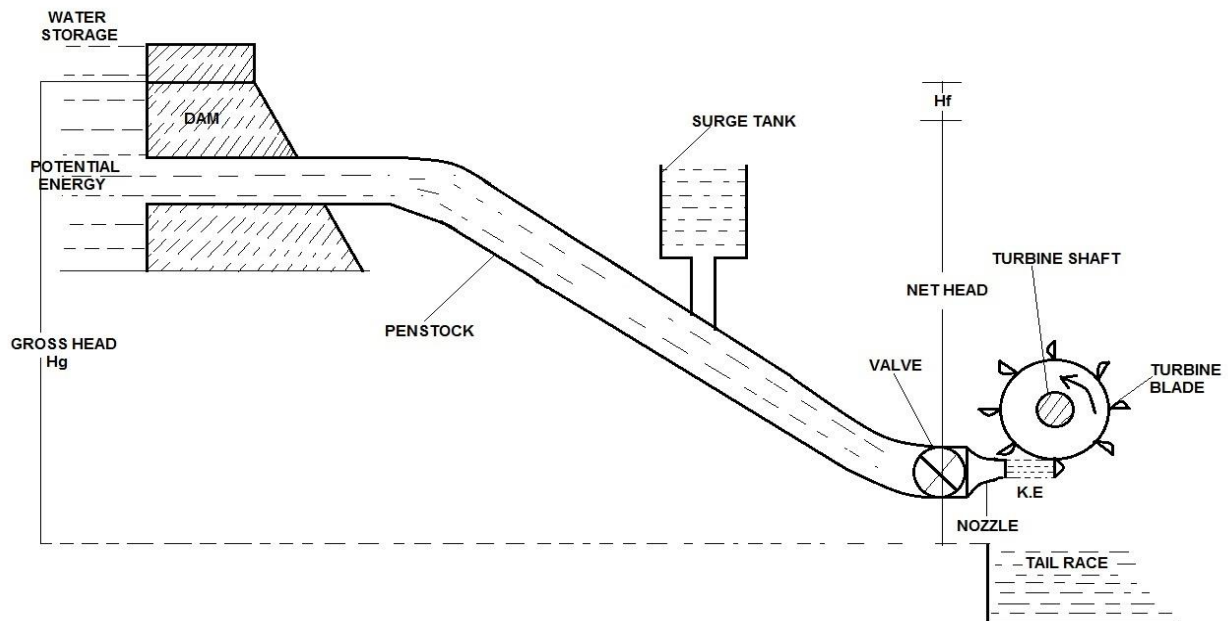

Layout of hydroelectric power plant

Working:

From the reservoir the water is carried to valve house through pressure tunnel and from valve house to the water turbine through pipes of large diameter made of steel or reinforced concrete, called the penstock. The water turbine converts hydraulic energy into mechanical energy and the alternator coupled to the water turbine converts mechanical energy into electrical energy. Water after doing useful work is discharged to the tailrace.

Selection of site of hydel power plant.

The following factors should be considered while selecting site for hydroelectric power plants.

- **Availability of Water:** Huge quantity of water is required for hydro-electric power plants because it runs on the energy possessed by flowing water. Availability of water for plant depends on the amount of rainfall, losses of water and storage of water.
- **Water Storage:** Building of dam across the river is essential to store water for plant. Water falling from the top of the dam possesses high energy. Before constructing the dam near the river detail study on the geographical and topographical features of catchment area is required.
- **Water Head:** The available water head depends upon the topography of the area. Availability of head of water has considerable effect on the cost and economy of power generation. In order to determine the most effective and economical head it is necessary to consider all possible factors which affect it.
- **Distance from Load Centre:** Hydroelectric power plant is usually located far away from the load centre.
- **Accessibility of the Site:** Adequate transportation facilities must be available.

- **Water Pollution:** Polluted water may cause excessive corrosion and damage to the metallic structures. Hence availability of good quality water is essential.
- **Large Catchment Area:** The reservoir must have a large catchment area so that level of water in the reservoir may not fall below the minimum required in dry season.
- **Availability of Land:** The land available should be cheap in cost and rocky in order to withstand the weight of the large building and heavy machinery.

List of hydro power stations with their capacities and number of units in the state

Sl. No.	Name of the Power Plant	Place	Capacity	No. of Units	
1	Odisha Hydro Power Corporation Limited (OHPCL)	Rengali	250 MW	5 x 50 MW	
2		Upper Kolab	320 MW	4 x 80 MW	
3		Upper Indravati	600 MW	4 x 150 MW	
4		Machkund		60 MW	3 x 23 MW
					3 x 17 MW
5		Burla		287.8 MW	2 x 49.5 MW
					2 x 32 MW
	2 X 43.65 MW				
	1 X 37.5 MW				
6	Chipilima		72 MW	3 x 24 MW	
7	Balimela		510 MW	6 x 60 MW	
				2 x 75 MW	

Different types of Turbines & Generators used in hydro power plant:

- There are two main types of hydro-power turbines such as: Reaction turbine and Impulse turbine.
- The type of hydropower turbine selected for a project is based on the height of standing water, known as Head and the flow or volume of water over time.
- Other deciding factors include how deep the turbine must be set, turbine efficiency and cost.

The different turbines used in hydro power plants are:

- Pelton turbine
- Francis's turbine
- Kaplan turbine

NOTE: Refer study material of Subject Hydraulic machines for turbines and numerical.

REFERENCE:

1. Study Material of Hydraulic Machines of previous semester.
2. Power Plant Engineering by R.K. Rajput (Book).
3. Fluid Mechanics & Hydraulic Machines by R.K. Bansal (Book)
4. <https://youtu.be/tpigNNTQix8>
5. https://youtu.be/_c9tBOjny28
6. https://youtu.be/UMz5GR7Nhqg?list=PLq7jO-L_k0yVmqNL4XVB9vOJ47_ysGYWn
7. https://youtu.be/1eYcjdGrXYA?list=PLq7jO-L_k0yVmqNL4XVB9vOJ47_ysGYWn
8. https://www.youtube.com/watch?v=BFoJOZbZ9FI&list=PLq7jO-L_k0yVmqNL4XVB9vOJ47_ysGYWn&index=13
9. https://youtu.be/TyygDiQPzaA?list=PLq7jO-L_k0yVmqNL4XVB9vOJ47_ysGYWn
10. https://youtu.be/RcdA2tGts_E?list=PLq7jO-L_k0yVmqNL4XVB9vOJ47_ysGYWn

GAS TURBINE POWER STATION

Gas Turbine Power Plant is used to generate electrical energy using air as the medium, which helps to rotate the turbines and connected to generators to develop electricity.

Elements of simple gas turbine power plants:

The gas turbine power plant generally comprises of a compressor which draws air into the engine, pressurise the air and feed the compressed air to the combustion chamber where the gas turbine fuels are burned in presence of compressed air and propelling force is generated from the burnt gases. The elements of gas turbine power plant are:

1. Compressor:

It draws air into the engine, pressurise the air and feed the compressed air to the combustion chamber at very high speeds.

2. Combustion system,

It is typically made up of a ring of fuel injectors that inject a steady stream of fuel into combustion chambers where it mixes with the air. The mixture is burned at temperatures of more than 2000 °F. The combustion produces a high temperature, high pressure gas stream that enters and expands through the turbine section.

3. Turbine:

It is an intricate array of alternate stationary and rotating aerofoil-section blades. As hot combustion gas expands through the turbine, it spins the rotating blades. The rotating blades perform a dual function such as: (i) they drive the compressor to draw more pressurized air into the combustion section, and (ii) they spin a generator to produce electricity.

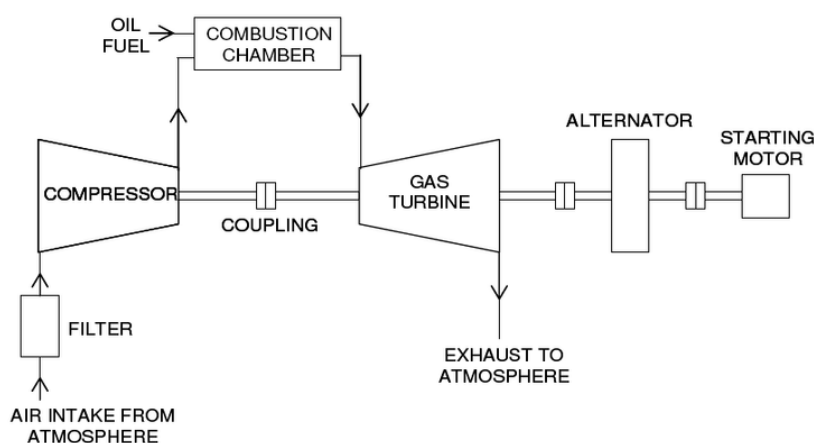

Layout of Gas turbine power plant

4. Alternator:

It is used to produce electricity when it runs by turbine.

Fuels of gas turbine power plants:

Gas turbines are mostly operated on natural gas or liquefied natural gas (LNG) because of its purity and ease of combustion.

Gas turbines uses liquid fuels and gaseous fuels.

Some examples of gas turbine fuels are:

1. *Gaseous fuels*: Natural gas, Blast furnace gas, Producer gas, Coal gas
2. *Solid fuels*: Pulverized coal.
3. *Liquid fuel*: Different types of oils used may distilled oils and residual oils.
4. Gasoline and Kerosene or blend of the two are also used.

Merits of gas turbine power plants:

The merits/advantages of gas turbine plant are:

- High operating speed.
- There is no smoke combustion occurred.
- It required less space.
- The capacity of work produced for 1 kg of air is high.
- The lubrication process is simple.
- Capital cost is less compared to other plants.
- There is no problem with ash content.
- It has higher mechanical efficiency.
- Required maintenance is less than another plants.
- It has high reliability.
- These plants are more flexible during operation.

Demerits of gas turbine power plants:

The demerits/disadvantages of gas turbine plant are:

- There is a need of external energy to start a compressor before the turbine starts.
- This plant has the different type of metals required than other plants.
- It requires a special type of cooling system or methods.
- The life of the plant is less.
- Layout of this plant is complex than diesel plant.
- These plants are more dangerous and has more risk.

Applications of gas turbine power plants:

Some applications of gas turbine plant are:

- To produce electricity.
- Used in turbo pumps, rotary compressors.
- Used in aircraft.
- Used in heavy engines like diesel engines.
- Used in marine engines.

Selection of site for gas turbine power plants:

1. It should be located near the Load centre to reduce transmission costs and the transmission losses.
2. Labour should be easily availability.
3. Site should be away from localities since it is noisy in operation.
4. Transportation facilities should be available easily.
5. Land should be available in cheap
6. Availability of land at cheap cost.
7. Bearing capacity of land should be high.

REFERENCE:

1. Power Plant Engineering by R.K. Rajput (Book).
-