



**KIITPOLYTECHNIC**  
**LECTURE NOTES**

**ON**

**RENEWABLE ENERGY SOURCE**

**Compiled by**

**Gautam Kumar Mahto**

(Lecturer, Department of Electrical Engineering, KIIT Polytechnic BBSR)

Email ID:- [gautam.mahto@kiit.ac.in](mailto:gautam.mahto@kiit.ac.in)

## CONTENTS

<b>S. No</b>	<b>Chapter Name</b>	<b>Page No</b>
1	Energy Situation and Renewable Energy Sources.	1-15
2	Solar radiation and collector	16-32
3	Low temperature application of solar energy	33-36
4	Passive space conditioning and collectors	36-42
5	Solar thermal Power plants	42-46
6	Solar photovoltaic	46-50
7	Wind Energy	50-52
8	Wind Energy converters	52-55
9	Energy Economics	55-57

# CHAPTER -1

## INTRODUCTION TO RENEWABLE ENERGY:

### Environmental consequence of fossil fuel:

- ✓ Fossil fuel is the fuel that comes from very old life form that decomposed over a long period of time. Example- coal, petroleum, natural gas etc. These fuels are called fossil fuel because they are dug up from underground.
- ✓ Petroleum and natural gas are formed by the anaerobic decomposition of remains of organism that are settled to the sea or lake bottom in large quantities under anoxic condition(absence of oxygen),this organic matter, mixed with mud and got buried under heavy layer of sediment.

### Limits Of Fossil Fuel

- ✓ **Environmental Hazards:** When fossil fuel is burnt, carbon dioxide gas is released into the atmosphere, herby causing global warming, as a result earth might face many problems.
- ✓ **Acid Rain:** sulphur dioxide is one of the pollutants that are released when fossil fuels are burnt and is a main cause of acid rain.
- ✓ **Effects on Human Health:** pollution from vehicles and coal powdered power plant can cause serious environmental hazards. Air pollution can result in human disease like asthma, lung cancer etc.
- ✓ **Impact on Aquatic Life by oil spill:** Transportation of crude oil via sea can cause oil spill which can pose hazard to the aquatic life by lessening the oxygen content of water.

### Energy Scenario

Any physical activity in this world, whether carried out by human beings or by nature, is caused due to flow of energy in one form or the other. The word 'energy' itself is derived from the Greek word 'en-ergon', which means 'in-work' or 'work content'. The work output depends on the energy input.

Energy is one of the major inputs for the economic development of any country. In the case of the developing countries, the energy sector assumes a critical importance in view of the ever-increasing energy needs requiring huge investments to meet them.

Energy can be classified into several types based on the following criteria:

- Primary and Secondary energy
- Commercial and Noncommercial energy
- Renewable and Non-Renewable energy
- Conventional and Non-conventional energy

### Primary and Secondary Energy

Primary energy sources are those that are either found or stored in nature. Common primary energy sources are coal, oil, natural gas, and biomass (such as wood). Other primary energy sources available include nuclear energy from radioactive substances, thermal energy stored in earth's interior, and potential energy due to earth's gravity.

Primary energy sources are mostly converted in industrial utilities into secondary energy sources for example coal, oil or gas converted into steam and electricity. Primary energy can also be used directly. Some energy sources have non-energy uses, for example coal or natural gas can be used as a feedstock in fertilizer plants.

### Commercial Energy and Non Commercial Energy

#### **Commercial Energy:**

The energy sources that are available in the market for a definite price are known as commercial energy. By far the most important forms of commercial energy are electricity, coal and refined petroleum products. Commercial energy forms the basis of industrial, agricultural, transport and

commercial development in the modern world. In the industrialized countries, commercialized fuels are predominant source not only for economic production, but also for many household tasks of general population.

Examples: Electricity, lignite, coal, oil, natural gas etc.

### **Non-Commercial Energy:**

The energy sources that are not available in the commercial market for a price are classified as non-commercial energy. Non-commercial energy sources include fuels such as firewood, cattle dung and agricultural wastes, which are traditionally gathered, and not bought at a price used especially in rural households. These are also called traditional fuels. Non-commercial energy is often ignored in energy accounting.

Example: Firewood, agro waste in rural areas; solar energy for water heating, electricity generation, for drying grain, fish and fruits; animal power for transport, threshing, lifting water for irrigation, crushing sugarcane; wind energy for lifting water and electricity generation.

### **Renewable and Non-Renewable Energy:**

Renewable energy is energy obtained from sources that are essentially inexhaustible. Examples of renewable resources include wind power, solar power, geothermal energy, tidal power and hydroelectric power. The most important feature of renewable energy is that it can be harnessed without the release of harmful pollutants.

Non-renewable energy is the conventional fossil fuels such as coal, oil and gas, which are likely to deplete with time

### **Conventional and Non-conventional energy resources:**

#### ***Conventional Energy:***

Conventional energy resources which are being traditionally used for many decades and were in common use around oil crisis of 1973 are called conventional energy resources, e.g., fossil fuel, nuclear and hydro resources.

## **Non-conventional energy:**

Non-conventional energy resources which are considered for large – scale use after oil crisis of 1973, are called non-conventional energy sources, e.g., solar, wind, biomass, etc.

## **What is sustainable Energy?**

It is the sustainable provision of energy that meets the need of the present without compromising the ability of future generation to meet their needs. Example—solar energy, wind energy, wave energy, tidal energy etc.

## **What is Sustainable Development?**

Sustainable development can be defined as an approach to the economic development of a country without compromising with the quality of the environment for future generations. In the name of economic development, the price of environmental damage is paid in the form of land degradation, soil erosion, air and water pollution, deforestation, etc.

## **Sustainable Development Goals:**

- To promote the kind of development that minimizes environmental problems.
- To meet the needs of the existing generation without compromising with the quality of the environment for future generations.

## **Achieving Sustainable Development**

Sustainable development can be achieved if we follow the following points:

- It can be achieved by restricting human activities.
- Technological development should be input effective and not input utilizing.
- The rate of consumption should not surpass the rate of salvation.
- For renewable resources, the rate of consumption should not surpass the rate of

production of renewable substitutes.

- All types of pollution should be minimized
- It can be achieved by sensible use of natural resources

### Examples of Sustainable Development

- Wind energy
- Solar energy
- Crop rotation
- Sustainable construction
- Efficient water fixtures
- Green space
- Sustainable forestry

### TYPES OF RE Sources

The most popular renewable energy sources currently are:

- Solar energy.
- Wind energy.
- Hydro energy.
- Tidal energy.
- Geothermal energy.
- Biomass energy.

### Limitation of RE sources:

- The Electricity Generation Capacity is Still Not Large Enough.
- Renewable Energy is Unreliable.
- Low-efficiency Levels.
- Requires a Huge Upfront Capital Outlay.
- Takes a Lot of Space to Install.

- Expensive Storage Costs.
- Not Always a Commercially-viable Option.
- It Still Generates Pollution

## CHAPTER-2

### SOLAR ENERGY

#### Introduction:

Solar energy is an important, clean, cheap and abundantly available renewable energy. It is received on Earth in cyclic, intermittent and dilute form with very low power density 0 to 1 kW/m<sup>2</sup>. Solar energy received on the ground level is affected by atmospheric clarity, degree of latitude, etc. For design purpose, the variation of available solar power, the optimum tilt angle of solar flat plate collectors, the location and orientation of the heliostats should be calculated.

#### Units of solar power and solar energy:

In SI units, energy is expressed in Joule. Other units are anglely and Calorie where

$$1 \text{ anglely} = 1 \text{ Cal/cm}^2 \cdot \text{day}$$

$$1 \text{ Cal} = 4.186 \text{ J}$$

For solar energy calculations, the energy is measured as an hourly or monthly or yearly average and is expressed in terms of kJ/m<sup>2</sup>/day or kJ/m<sup>2</sup>/hour. Solar power is expressed in terms of W/m<sup>2</sup> or kW/m<sup>2</sup>.

#### WHAT IS SOLAR ENERGY?

Solar energy from the sun that is converted into thermal or Electrical energy using solar cell is known as solar energy. It's a clean form of energy or green energy, as it doesn't cause any pollution

#### Photo Voltaic Cell Or Solar Cell:

The Photovoltaic cell is the semiconductor device that converts the light into electrical energy. The voltage induced by the PV cell depends on the intensity of light incident on it. The name Photovoltaic is because of their voltage producing capability

#### Construction of Photovoltaic Cell



- ✓ The semiconductor materials like arsenide, indium, cadmium, silicon, selenium and gallium are used for making the PV cells. Mostly silicon and selenium are used for making the cell.
- ✓ Consider the figure below shows the constructions of the silicon photovoltaic cell. The upper surface of the cell is made of the thin layer of the p-type material so that the light can easily enter into the material.
- ✓ The metal rings are placed around p-type and n-type material which acts as their positive and negative output terminals respectively.

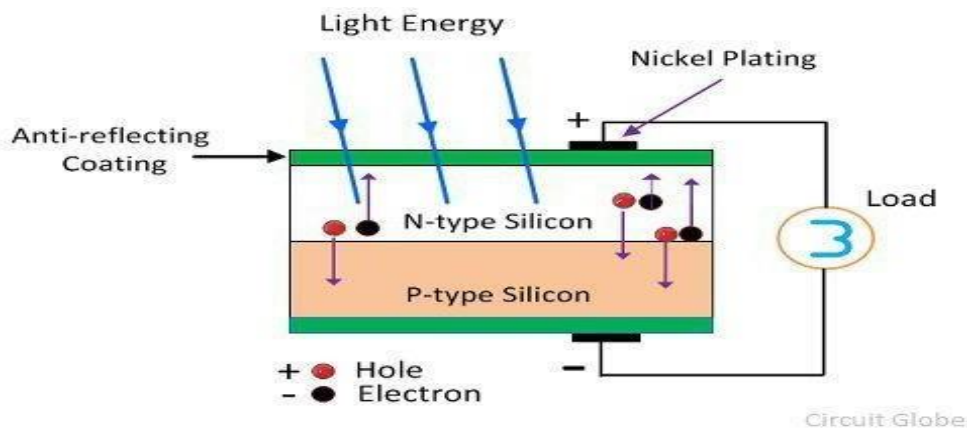

The multi-crystalline or monocrystalline semiconductor material makes the single unit of the PV cell. The mono-crystal cell is cut from the volume of the semiconductor material. The multicells are obtained from the material which has many sides.

The output voltage and current obtained from the single unit of the cell is very less. **The magnitude of the output voltage is 0.6v, and that of the current is 0.8v.** The different combinations of cells are used for increasing the output efficiency. There are three possible ways of combining the PV cells.

## Working of PV cell

The light incident on the semiconductor material may be pass or reflected through it. The PV cell is made of the semiconductor material which is neither a complete conductor nor an insulator. This property of semiconductor material makes it more efficient for converting the light energy into electric energy.

When the semiconductor material absorbs light, the electrons of the material starts emitting. This happens because the light consists small energies particles called photons. When the electrons

absorb the photons, they become energized and starts moving into the material.

Because of the effect of an electric field, the particles move only in the one direction and develop current. The semiconductor materials have the metallic electrodes through which the current goes out of it.

Consider the figure below shows the PV cell made of silicon and the resistive load is connected across it. The PV cell consists of P and N-type layer of semiconductor material. These layers are joined together to form the PN junction.

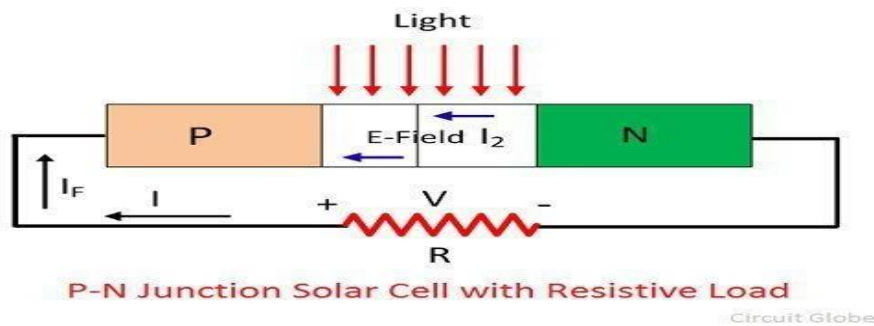

The junction is the interface between the [p-type](#) and [n-type material](#). When the light fall on the junction the electrons starts moving from one region to another.

## How Solar Cell Install on the Solar Power Plant?

Maximum power point tracker, inverter, charge controller and battery are the name of the apparatus used for converting the radiation into an electrical voltage.

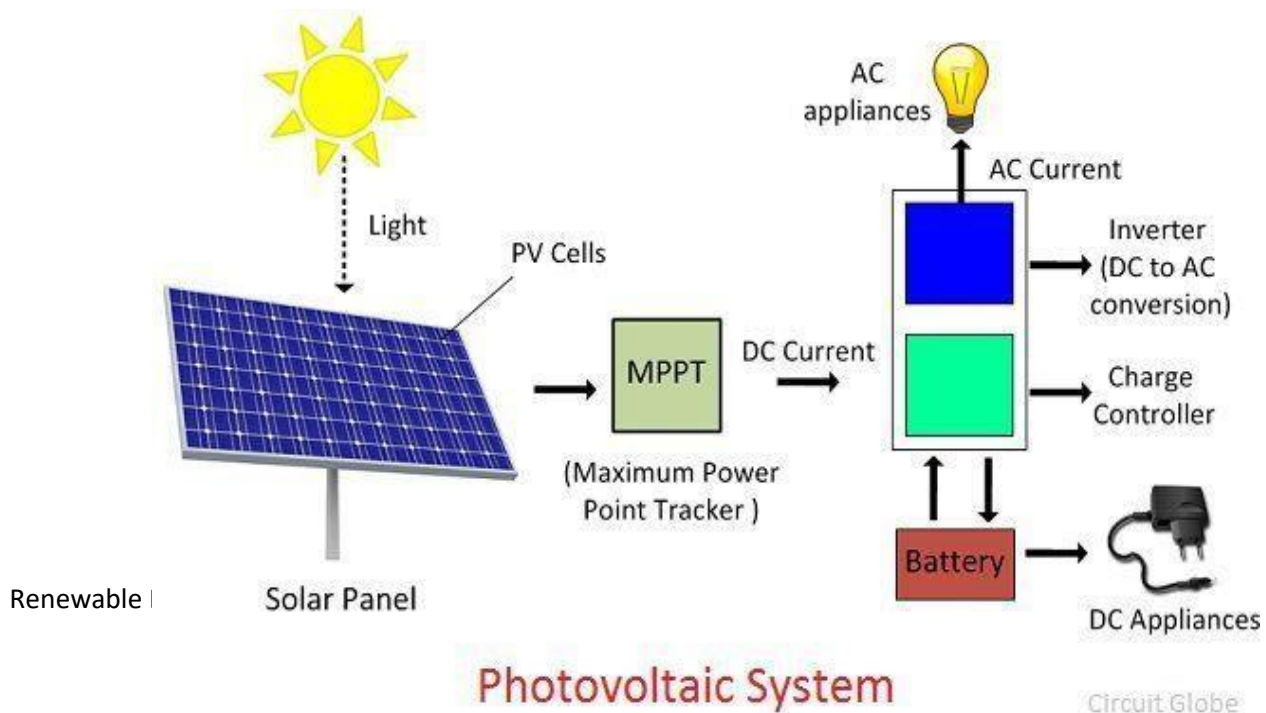

**Maximum Power Point Tracker** – It's a special kind of digital tracker that follows the location of the sun. **The efficiency of the PV cell depends on the intensity of sunlight fall on it.** The power of the sun varies with the time because of the movement of the earth. So for absorbing the maximum light, the panel needs to be moved along with the sun. Thereby the maximum power point tracker is used with the solar panel.

**Charge Controller** – The charge controller regulates the voltage drawn from the panel. It also protects the battery from the overcharging or overvoltage.

**Inverter** – The inverter converts the direct current into the alternating current and vice versa. The conversion is essential because some of the appliances require ac supply for their work

### **PHOTO-VOLTAIC CELL CONCEPT:**

#### **CELL, MODULE, ARRAY**

- Photo-voltaic cell are connected electrically in series or parallel to produce higher voltage, current, power level.
- Photo-voltaic module are consist of PV cell circuits sealed in a environmentally protective laminate and are the fundaments blocks of PV systems

Photo-voltaic array is the complete power generating unit, consisting of any number of PV module and panel.

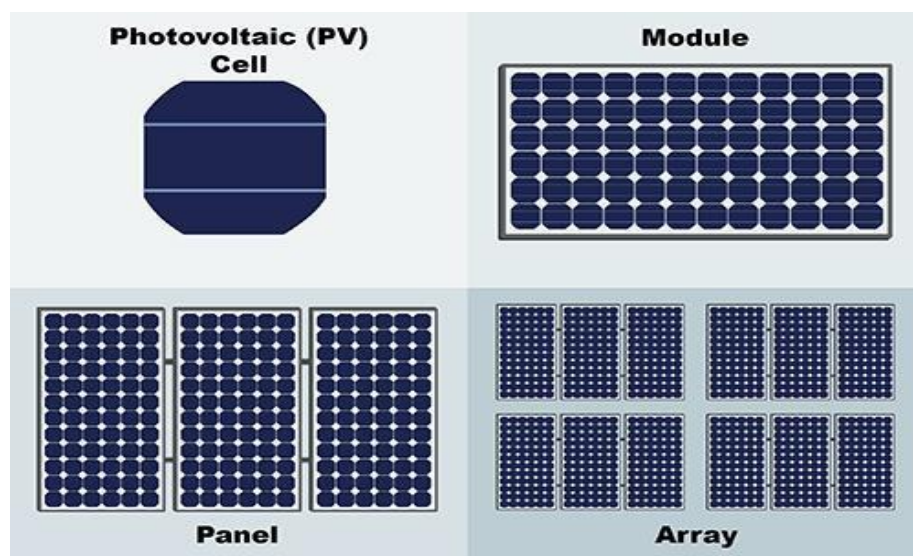

## Series Combination of PV Cells

If more than two cells are connected in series with each other, then the output current of the cell remains same, and their input voltage becomes doubles. The graph below shows the output characteristic of the PV cells when connected in series.

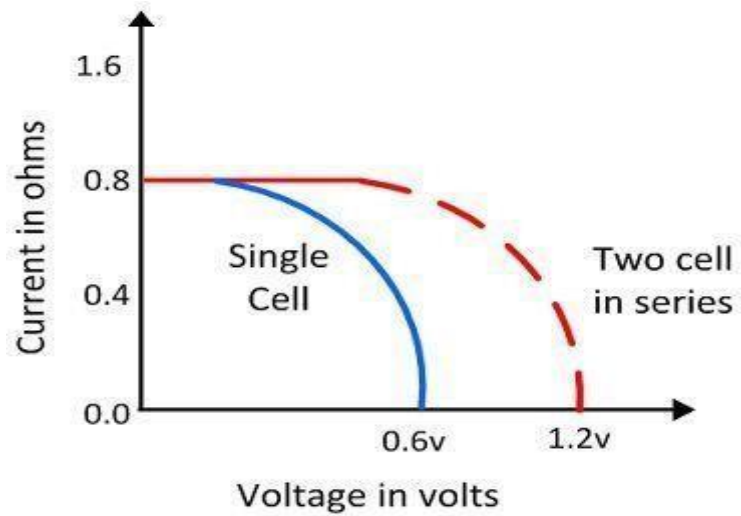

**Current Same Voltage Double**

Circuit Globe

## Parallel Combination of PV cells

In the parallel combination of the cells, the voltage remains same, and the magnitude of current becomes double. The characteristic curve of the parallel combination of cells is represented below.

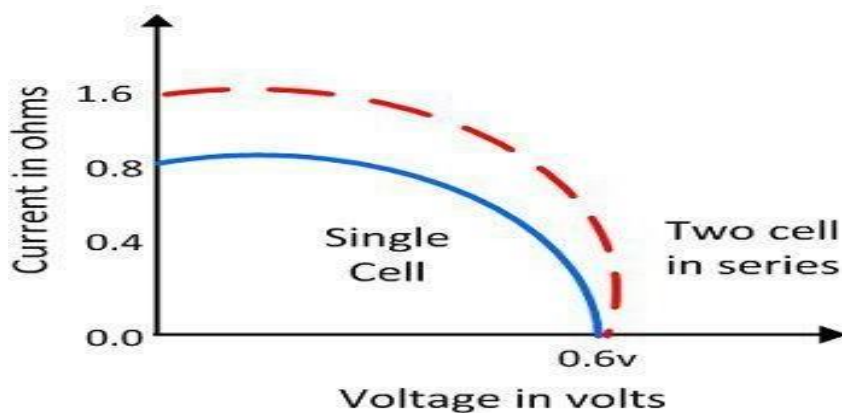

**Voltage Same Current Double**

Circuit Globe

## CLASSIFICATION OF ENERGY SOURCES

It is classified on the basis of

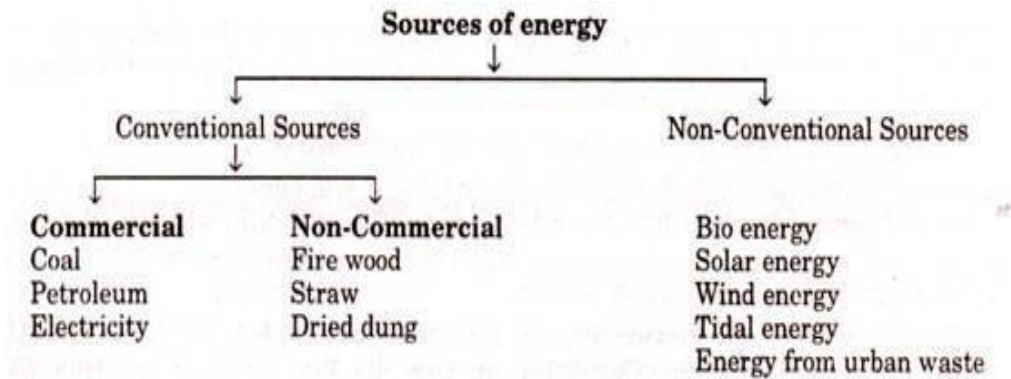

### Conventional sources of energy

Conventional sources of energy are the natural energy resources which are present in a limited quantity and are being used for a long time. They are called non-renewable sources as once they are depleted, they cannot be generated at the speed which can sustain its consumption rate. They are formed from decaying matter over hundreds of millions of years. Examples of conventional sources of energy include coal, petroleum, natural gas and electricity.

### Non-conventional sources of energy:

Non-conventional sources of energy are the energy sources which are continuously replenished by natural processes. These cannot be exhausted easily, can be generated constantly so can be used again and again, e.g. solar energy, wind energy, tidal energy, biomass energy and geothermal energy etc.

### SOLAR ENERGY:

- Every day, the sun radiates (sends out) an enormous amount of energy- called solar energy. It radiates more energy in one day than the world use in one year. This energy comes from within the sun itself.
- Like most stars, the sun is big gas ball made up mostly of hydrogen and helium gas. The sun makes energy in its inner core in a process called nuclear fusion. It takes the sun's energy just a little over eight minutes to travel the 93 million miles to earth. Solar energy

travels at the speed of light, or 18600 miles per second, or  $3.0 \times 10^8$  meters per second

- Only a small part of the visible radiant energy (light) that the sun emits into space ever reaches the earth, but that is more than enough to supply all our energy needs. Every hour enough solar energy reaches the earth to supply our nation's energy needs for a year. Solar energy considered a renewable energy source due to this fact.

## Solar radiation and solar constant

- All substances solids, liquids and gases at temperature above zero emit energy in form of electromagnetic waves. This energy is called radiation. Radiation is a process by which heat flows from a body at a higher temperature to a body at a lower temperature when the bodies are separated them.
- A perfect radiator ( called black body ) emits energy from its surface at a rate Q is given by

$$Q = \sigma AT^4$$

- Where ,

$\sigma$  = stefan boltzman constant =  $5.67 \times 10^{-8} \text{ W/m}^2\text{K}^4$

A = heat transfer surface area of the body ,  $\text{m}^2$

T = absolute temperature of body , K

- For a real body ,  $Q = \epsilon \sigma AT^4$

$$\epsilon = \frac{\text{Radiation emission of a real body}}{\text{radiation emission of a balck body}}$$

where ,  $\epsilon$  = Emissivity of the surface

## Absorptivity , reflectivity and transmissivity

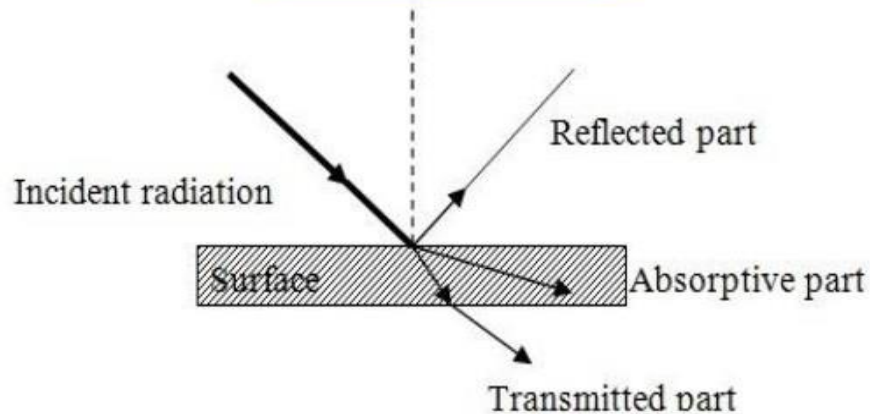

## Solar constant ( $I_{SC}$ )

- **Solar constant (  $I_{SC}$  )** : Total energy received from the sun per unit time on a surface of unit area kept perpendicular to the radiation in space just outside the earth's atmosphere when the earth is at its mean distance from the sun.
- a standard value of solar constant is  $1353 \text{ W/m}^2$  .
- The earth is closet to the sun in the summer and furthest away in the winter. This variation in distance produces a nearly sinusoidal variation in the intensity of solar radiation  $I$  that reaches earth.
- The value on any day can be calculated from the equation ,

$$\frac{I}{I_{SC}} = 1 + 0.33 \cos \left[ \frac{360n}{365} \right]$$

Where,  $n$  = the day of year

## Extraterrestrial radiation (solar radiation outside the earth's atmosphere)

- Solar radiation incident on the outer atmosphere of earth is known as extraterrestrial radiation.
- The extraterrestrial radiation available at mean sun-earth distance for zero air mass and  $1353 \text{ W/m}^2$  as the solar constant.
- About 99% of the extraterrestrial radiation has wavelengths in the range from 0.2 to  $4 \mu\text{m}$  with maximum spectral intensity at  $0.48 \mu\text{m}$  (green portion of visible range).
- About 6.4% of extraterrestrial radiation energy is contained in the ultraviolet region ( $\lambda > 0.38$ ), another 48% is contained in the visible region ( $0.38 \mu\text{m} < \lambda < 0.78 \mu\text{m}$ ) and the remaining 45.6% is contained in the infrared region ( $\lambda > 0.78$ ).

## Solar radiation at the earth's surface (Terrestrial radiation)

- The solar radiation that reaches the earth surface after passing through the earth's atmosphere is known as terrestrial radiation.

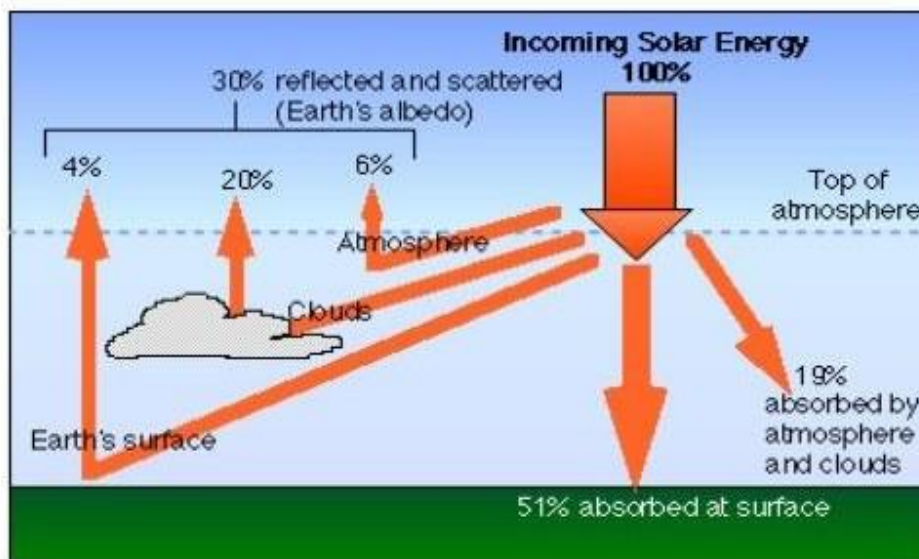



- A selective absorption of various wavelengths occurs different molecules. The absorbed radiation increases the energy of the absorbing molecule and hence rising their temperatures. Ozone absorb an ultraviolet radiation,  $N_2$ ,  $O_2$  and other atmospheric gases absorb the X-rays and extreme ultraviolet radiations.  $H_2O$  and  $CO_2$  absorb almost completely the infrared radiation. Dust particles and air molecules also absorb a part of solar radiation irrespective of wavelength.
- Solar radiation propagation in a straight line and received at the earth surface without change of direction called **direct or beam radiation**.
- Solar radiation scattered by dust particle and air molecules (or gaseous particle of different sizes) is lost (reflected back) to space and the remaining is directed down ward to the earth's surface from different direction is called **diffuse radiation**.
- The energy reflected back to the space by reflection from cloud, scattering by the atmospheric gases and dust particle, and by reflection from earth surface is called **albedo** of earth atmospheric system and has a value of about 30% of the incoming solar radiation for the earth as a whole.
- The sum of beam and diffuse radiation is referred to as '**total or global radiation (insulation)**'.
- The radiation, therefore, available on the earth's surface (terrestrial radiation) is less that what is received outside the earth's atmosphere (extraterrestrial radiation).
- This reduction in intensity depends on atmospheric condition and distance travelled by beam radiation through the atmosphere before it reaches a location on the earth's surface.
- A term called **air mass(m)** is often used as a measure of the distance travelled by beam radiation through the atmosphere before it reaches a location on the earth's surface.

$$\text{air mass, } m = \frac{\text{path length traversed by beam radiation}}{\text{vertical path length of atmosphere}}$$

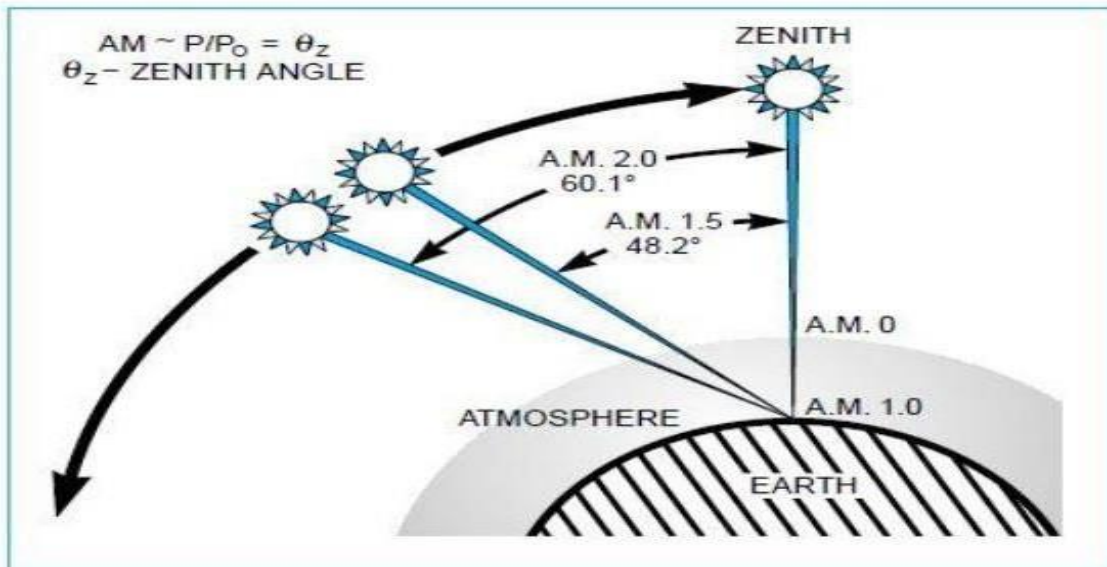

## Solar geometry (basic terms)

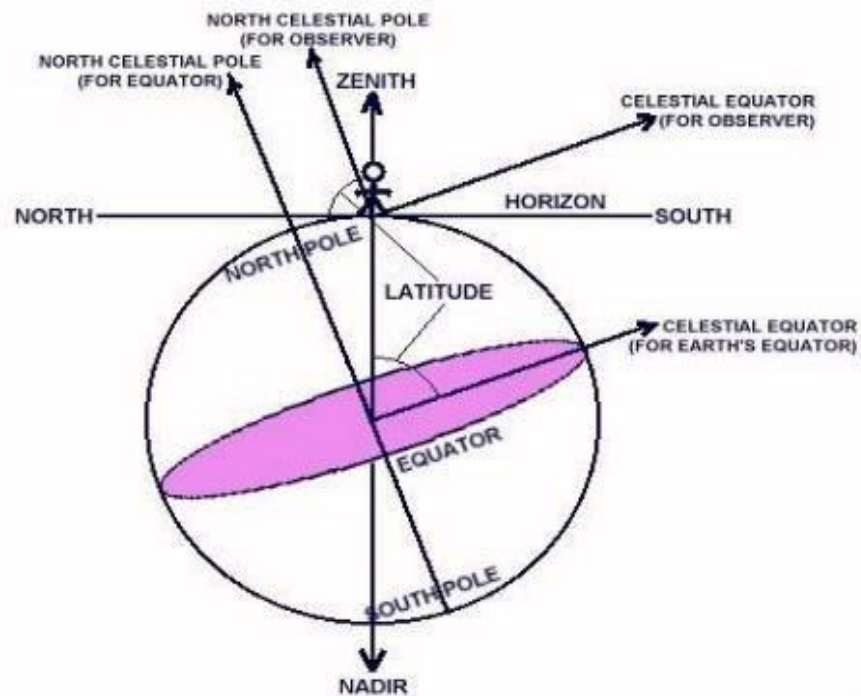

**Celestial sphere:** During the clear night, in the sky, the stars, planets, moon etc. are all located the same distance away from the observer. The sky may conveniently be assumed to be a large sphere. This imaginary transparent sphere surrounding the earth is called the celestial sphere.

- **Zenith:** it is a point on the celestial sphere over the observer's head.
- **Nadir:** It is a point on the celestial sphere diametrically opposite to the zenith.
- **Visible horizon:** It appears to an observer that the celestial sphere meets the ground, the location of this apparent meeting is called the visible horizon.
- **Astronomical horizon:** It is circle on celestial sphere, the plane of which passes through the central of the earth normal to the line joining the centre of the earth and the zenith.
- **Poles of earth:** The points mark on the earth surface at and of the axis of rotation of the earth are called poles of the earth, one as North, while the other as a South.
- **Earth's equator:** The earth's equator is an great circle normal to the earth's axis, dividing the distance between earth's poles along its surface into two equal parts.
- **Meridian:** An imaginary great circle passing through reference point (Royal observatory Greenwich, outside the London) and the two poles, intersecting the equator at right angle, is called the prime (or Greenwich) meridian.
- **Longitude:** It is the angular distance of the location, measured east or west from the prime meridian.

## Basic earth-sun angles

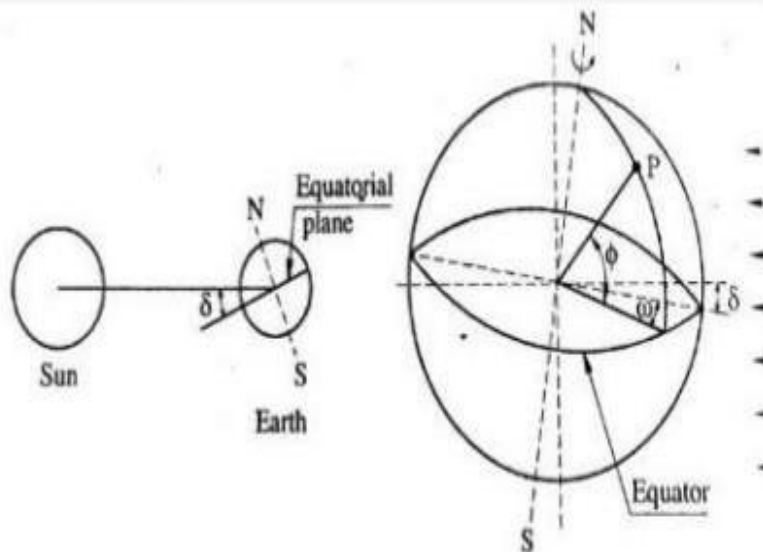

**Angle of latitude( $\Phi$ ):** It is the vertical angle between the lining joining that point of location to the centre of the earth and its projection on an equatorial plane. When the point is north of equator the angle is positive and when south is negative.

- **Declination angle ( $\delta$ )** : it is the angle between a line extending from the centre of the sun to the centre of the earth, and the projection of this line upon the earth's equatorial plane.
- It is positive when measured above the equatorial plane in the northern hemisphere.

$$\delta = 23.45 \sin\left[\frac{360(284+n)}{365}\right]$$

- **Hour angle( $\omega$ )** : It is the angle representing the position of the sun with respect to clock hour and with reference to sun's position at 12 noon.

$$\text{Hour angle}(\omega) = \pm[12:00 - \text{solar time}] (\text{in hours}) \times 15^\circ$$

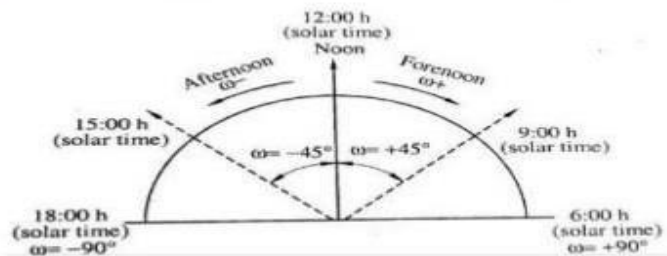

- **Inclination angle (altitude),  $\alpha$**  : The angle between the sun's ray and its projection on a horizontal surface is known as the inclination angle as shown in figure. It could be seen that the sunrise and at sunset the angle  $\alpha$  is zero.

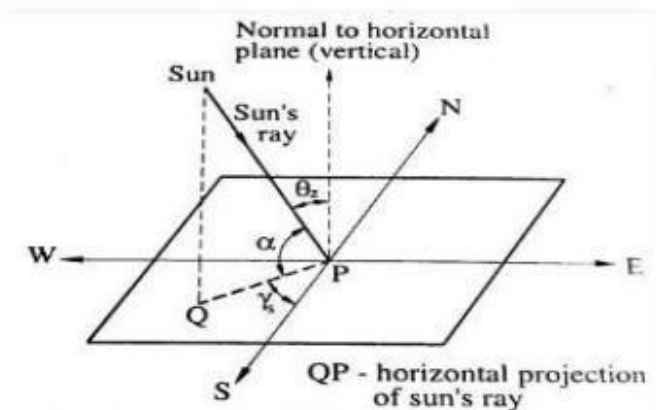

- **Zenith angle( $\theta_z$ )** : It is the angle between the sun's ray and the perpendicular (normal) to the horizontal plane as shown in figure. The Zenith angle is the complement of altitude angle, i.e.  $\alpha + \theta_z = 90^\circ$ . Hence at sunrise and sunset the zenith angle  $\pm 90^\circ$ . The positive value is for sunrise and negative value for sunset.
- **Solar azimuth angle( $Y_s$ )** : It is the angle on a horizontal planes, between the line due south and the projection of the sun's ray on the horizontal planes. It is considered a positive when it measured from south toward west as shown in figure.

## Solar radiation measurements

- Three types of instruments are generally used to measure three different aspects of solar radiation as follow :
- **To measure global or diffuse radiation:** A **Pyranometer** is designed to measure global radiation, usually on a horizontal surface, but can also be used on an inclined surface. Pyranometer also measure diffused radiation by using a shading ring.
- **To measure beam or direct radiation:** A **pyrheliometer** is used to measure beam radiation by using a long narrow tube to collect only beam radiation from the sun at normal incidence.
- **To measure sunshine hours in a day:** A **sunshine recorder** is used to measure the duration in hours or bright sunshine during the course of the day.
- **To measure terrestrial radiation:** A **pyregeometry** is used to measure terrestrial radiation.
- **To measure both solar and terrestrial radiation:** A **pyradiometer** is used to measure both solar and terrestrial radiation.

Solar collector is classified based on the way they collect solar radiation.

### Classification of solar collectors

- 1) Non-concentrating type
- 2) Concentrating type

#### ➤ Non-concentrating type :

- 1) Flat plate collector
  - a) Liquid flat plat collector
  - b) Flat plate air heating collector

#### ➤ Concentrating type :

- 1) Focus type
  - a) Line focus type ( one axis tracking )
    - i ) Cylindrical parabolic concentrator
    - ii ) Fixed mirror solar concentrator
    - iii ) Linear Fresnel lens concentrator

b) Point focus type ( two axis tracking )

- i) Hemispherical bowl mirror concentrator
- ii ) Circular Fresnel lens concentrator
- iii) Parabolic dish collector
- iv) Central tower receiver

2) Non-focus type

- a) Modified flat plate collector
- b) Compound parabolic concentrator

Non concentrating type solar collector	Concentrating type solar collector
<ul style="list-style-type: none"> <li>• In this collectors it absorbs the radiation as it is received on the surface of the collector</li> </ul>	<ul style="list-style-type: none"> <li>• In these collectors solar radiation is converged from a large area into a smaller area using optical means. or in this case is first increase the concentration of radiation per unit area before absorbing it</li> </ul>
<ul style="list-style-type: none"> <li>• Both beam and diffused radiation is required</li> </ul>	<ul style="list-style-type: none"> <li>• <b>Concentration</b> can be obtained by reflection or refraction of <b>solar</b> radiation by the use of mirrors or lens</li> </ul>
<ul style="list-style-type: none"> <li>• It is simple in construction and No need of solar tracker is required</li> </ul>	<ul style="list-style-type: none"> <li>• Solar tracker is required</li> </ul>
<ul style="list-style-type: none"> <li>• High temperature is not obtained because of absence of optical concentration, the area from which heat is lost is large</li> </ul>	<ul style="list-style-type: none"> <li>• High temperature can be obtained due to concentration of radiation</li> </ul>
<ul style="list-style-type: none"> <li>• It is fixed on a rigid platform and because it requires less maintenance.</li> </ul>	<ul style="list-style-type: none"> <li>• Diffused radiation cannot be obtained.</li> </ul>
<ul style="list-style-type: none"> <li>• It has simple and compact construction</li> </ul>	<ul style="list-style-type: none"> <li>• It has flexible construction.</li> </ul>

## Solar Energy applications

Energy from sun can be categorised in two ways: in the form of heat and light. We use the solar energy every day in many different ways. When we hang laundry outside to dry in the sun, we are using the solar heat to dry our clothes. Plants make their food in the presence of sunlight. Animals and humans get food from plants. Fossil fuels are actually *solar energy* stored millions and millions of years ago.

There is variety of products that uses solar energy. These products are called solar devices (or appliances) or solar thermal collectors. Solar thermal technologies uses the solar heatenergy to heat water or air for applications such as space heating, pool heating and water heating for homes and businesses

Some of the major applications of solar energy are as follows

- Solar water and air heating
- Solar pumping
- Solar cooking
- Solar pumping

## Solar Cooker

A 'solar cooker' is a device which uses the energy of direct sunlight to heat, cook or pasteurize food or drink. Many solar cookers currently in use are relatively inexpensive, low-tech devices, although some are as powerful or as expensive as traditional stoves, and advanced, large-scale solar cookers can cook for hundreds of people. Because they use no fuel and cost nothing to operate, many nonprofit organizations are promoting their use worldwide in order to help reduce fuel costs (especially where monetary reciprocity is low) and air pollution, and to slow down the deforestation and desertification caused by gathering firewood for cooking. Solar cooking is a form of outdoor cooking and is often used in situations where minimal fuel consumption is important, or the danger of accidental fires is high, and the health and environmental consequences of alternatives are severe.

## Types of solar cooker

1. For household cooking : Box type solar cooker
2. For community cooking : Concentrator type solar cookers

## Box Type solar cooker

The solar rays penetrate through the glass covers and absorbed by blackened metal trays (Boxes) kept inside the cooker. The upper cover has two glass sheets each 3 mm thick fixed in the wooden frame with 20 mm distance between them. This prevents the loss of heat due to re-radiation from blackened surface. The loss due to convection is minimized by making the box air-tight by providing a rubber strap all round between the upper lid and the box. Insulating material like glass wool saw dust or any other material is filled in the space which minimizes heat loss due to conduction. When this type of cooker is placed in the sun, the blackened surface starts absorbing sunrays and temperature rises. The food in the trays is cooked. The temperature of cooking depends upon the intensity of radiation. The size of a box type cooker is 50×50×12 cm. Overall dimensions of the latest model are 60×60×20 cm. This type of cooker is termed as family solar cooker as it cooks sufficient dry food materials for a family of 5 to 7 people. The temperature attained is about 100°C. With the addition of single glass reflector, 15-20°C more temperature is obtained and the cooking time is reduced.

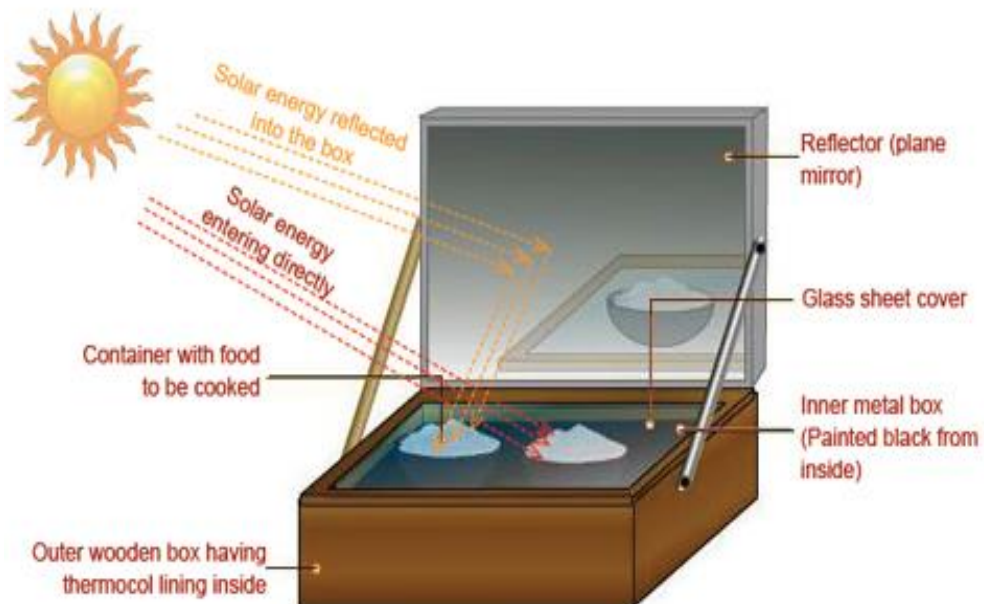



## Concentrator type solar cooker for community cooking

It works on the principle of solar energy concentration using a Reflecting Parabolic Solar Concentrator. A parabolic solar concentrator is used for concentrating solar radiation on a focal area where the cooking vessel is placed.

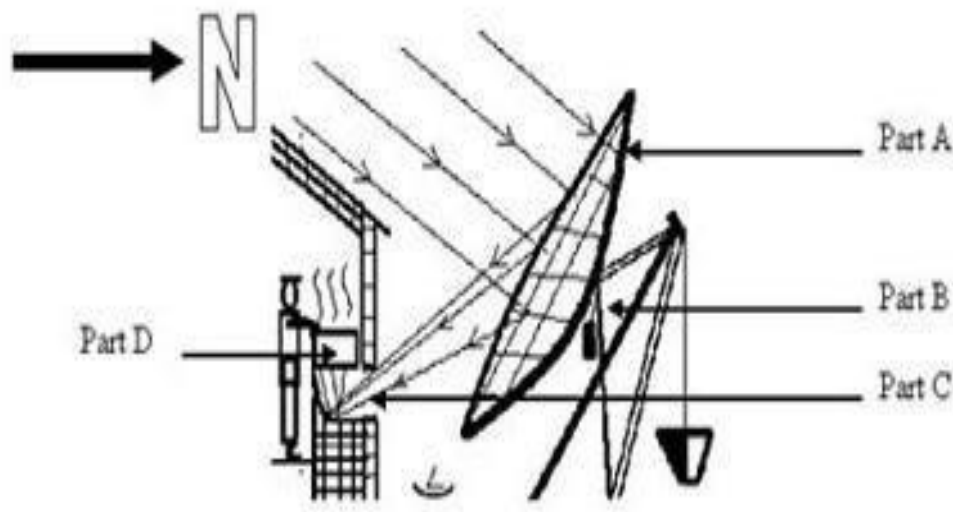

- Part A - Solar Concentrating Disc (Primary Reflector) - The disc which helps in concentrating solar energy to a focal point.
- Part B- Automatic Tracking System - With the help of a simple automatic mechanical tracking system the solar disc rotates in the direction of the movement of the Sun to give continuous and accurate solar energy concentration.
- Part C - Secondary Reflector - This is provided opening in the north-facing wall of the kitchen or the cooking place just below the cooking vessel. This reflector receives the concentrated solar radiation and reflects it

## Merits of solar cooker

- No requirement of cooking gas or kerosene, electricity, coal or wood.
- No need to spend on fuel, as solar energy is available free.
- No loss of vitamins in the food: Food cooked in solar cooker is nutritious. About 10-20% of protein retention is more as compared to that in conventional cooking. Vitamin thiamine retention is about 20 to 30% more whereas vitamin A is retained 5 to 10% more when food is cooked in solar cooker.
- No orientation to sun is needed
- No attention is needed during cooking.
- No fuel, maintenance and recurring cost.
- Simple to use and fabricate.
- Solar cooking is pollution free and safe.
- Solar cookers come in various sizes. Based on the number of family members, the size of the cooker can be chosen.
- All cooking activities (like boiling, roasting) can be done using a solar cooker.
- There are government schemes which offer subsidies to purchase solar cookers.

## Demerits of solar cooker

- Adequate sunshine is required for cooking: Cooking can be done only when there is sunshine.
- Takes longer time to cook food than the conventional cooking methods
- All types of foods cant are cooked.

## Solar water heater

A solar water heating unit comprises a blackened flat plate metal collector with an associated metal tubing facing the general direction of the sun. The plate collector has a transparent glass cover above and a layer of thermal insulation beneath it. The metal tubing of the collector is connected by a pipe to an insulated tank that stores hot water during cloudy days. The collector absorbs solar radiations and transfers the heat to the water circulating through the tubing either by gravity or by a pump.

This hot water is supplied to the storage tank via the associated metal tubing. This system of water

heating is commonly used in hotels, guest houses, tourist bungalows, hospitals, canteens as well as domestic and industrial units.

It consists mainly of:

- A thermal panel (solar collector) installed on the roof;
- A tank to store hot water;
- Accessories, such as a circulating pump to carry the solar energy from the collector to the tank, and a thermal regulator.

Small capacity domestic solar water heaters are also available in simpler design, in which the functions of the collector and storage tank are combined in one unit. The hot water is used for domestic purposes or meeting the needs of industries and commercial establishments. Solar water heating systems can be classified into two categories:

- (i) Natural circulation (thermo-syphon) system
- (ii) Forced circulation system

## Natural circulation water heating system

Basic elements of a solar water heating system are: (i) flat plate collector, (ii) storage tank, (iii) circulation system (iv) auxiliary heating system and (v) control of the system. Natural circulation system consists of a tilted collector, with transparent cover plates, a separate, highly insulated water storage tank, and well-insulated pipes connecting the collector and storage tank. The bottom of the storage tank is at least a foot higher than the top of the collector, and no auxiliary energy is required to circulate water through it. Circulation occurs through natural convection, or thermo-siphoning. When water in the collector is heated by the sun, it expands (becomes less dense) and rises up the collector, through a pipe and into the top of the storage tank. This forces cooler water at the bottom of the tank and flow out from storage tank by gravity, enter into the bottom of the collector through pipe provided at the bottom of the storage tank.

This water, in turn, is heated and rises up into the tank. As long as the sun shines the water will quietly circulate, getting warmer. After sunset, a thermo-siphon system can reverse its flow direction and loss heat to the environment during the night. To avoid reverse flow, the top heater

of the absorber should be at least 1 foot below the bottom of the storage tank. To provide heat during long, cloudy periods, an electrical immersion heater can be used as a backup for the solar system.

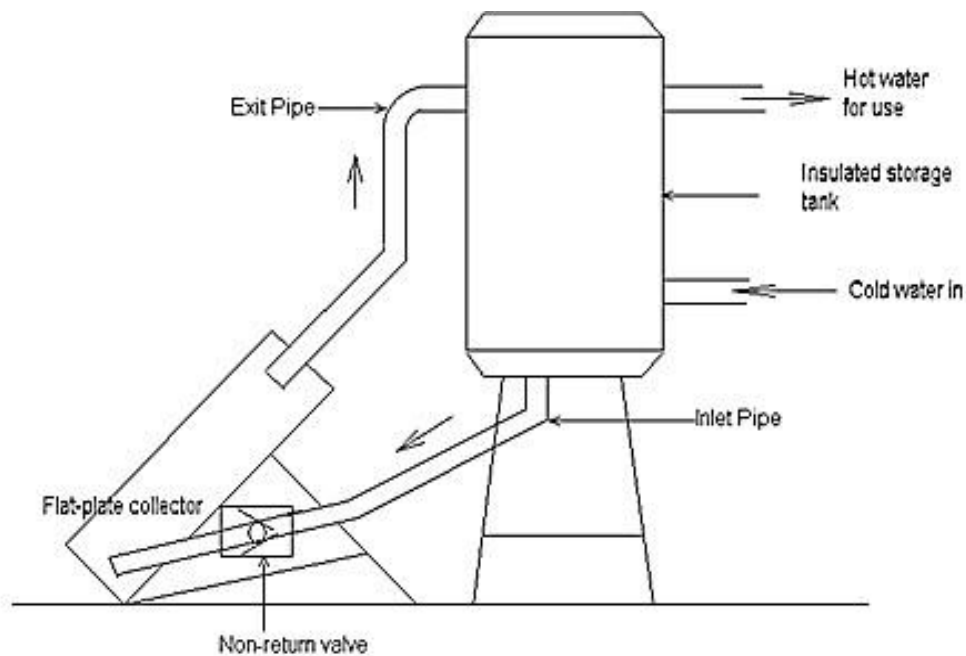

### Forced circulation water heating system

The forced circulation water heating system is suitable for supplying hot water to community centers such as hostels, hotels etc., and industries. Large array of flat-plate collectors are then used and forced circulation is maintained with a water pump. The restriction to keep storage tank at a higher level is not required, as done in the case of natural circulation water heating system. Depending on the size of storage tank, a group of flat plate collectors are selected and connected together. The storage tank is maintained with cold water fully by connecting to a make-up water tank which is provided with ball-float control mechanism. The pump for maintaining the forced circulation is operated by an on-off controller which senses the difference between the temperature of water at the exit of collectors and a suitable location inside the storage tank. When the temperature in the storage tank is reduced, the thermal controlling system operates the pump and cold water is pumped to the collectors. The cold water gets heated up in the collector and the flow to the storage tank. If the temperature of water in the storage tank reaches to a predetermined value, the pump automatically stop the pumping water from the tank

to collector. If the temperature of hot water falls, the pump starts working and water flows to collector. In the absence of solar energy, the auxiliary heater operated by electrical power is used. The auxiliary heater has to be kept in the storage tank

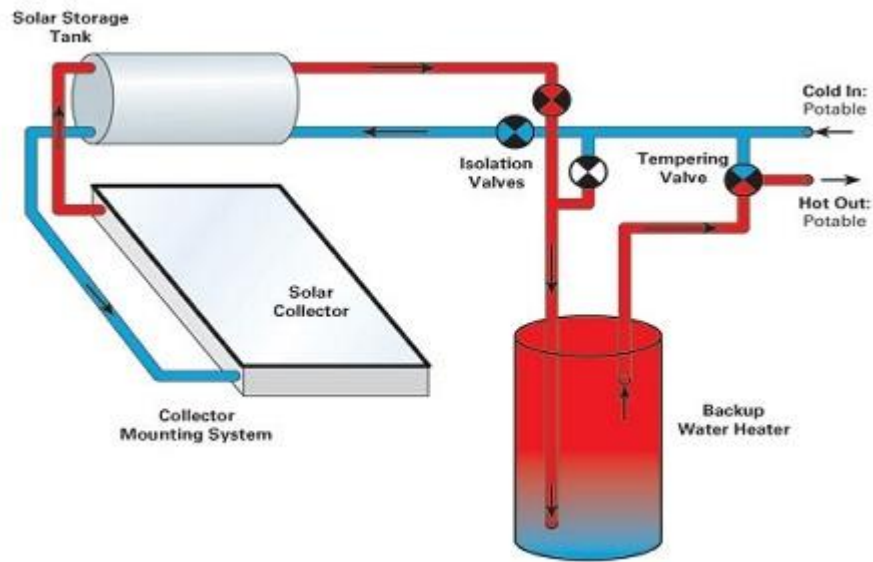

## Chapter-3

### WIND ENERGY

#### Introduction:

Wind is simple air in motion. It is caused by the uneven heating of the earth's surface by the sun. Since the earth's surface is made of very different types of land and water, it absorbs the sun's heat at different rates. Energy derived from wind velocity is wind energy. It is a non-conventional type of energy, which is renewable with suitable devices. This energy can be used as a perennial source of energy. Wind energy is obtained with the help of wind mill. The minimum wind speed of 10kmph is considered to be useful for working wind mills for agricultural purpose. Along the sea coast and hilly areas, wind mills are likely to be most successful in Karnataka, Maharashtra and Gujarat.

The wind energy over earth is estimated to be  $1.6 \times 10^7$  M.W, which is equivalent to the energy consumed. But, the wind energy is available in dilute form. The conversion machines are large. The wind energy varies from time to time and place to place. Due to this reason some storage facility is required. The kinetic energy of wind is converted into useful shaft power by wind mills. General applications of wind mills are pumping water, fodder cutting, grain grinding, generation of power etc. In India, wind speed lies between 5 kmph-20 kmph. The high wind velocity is seasonal. The wind energy, if used for power generation, it will be uncertain to generate power. In India, wind power can be used for lifting water in rural areas for drinking and for irrigation purpose.

#### Factors affecting the wind

- Latitude of the place
- Altitude of the place.
- Topography of the place 4. Scale of the hour, month or year

#### Suitable places for the erection of wind mills

- Off-shore and on the sea coast: An average value is  $2400 \text{ kWh/m}^2/\text{year}$

- Mountains: An average value is 1600 KWH/m<sup>2</sup>/year
- Plains: An average value is 750 KWH/m<sup>2</sup>/year

## Types of wind mills

There are two types of wind machines (turbines) used today based on the direction of the rotating shaft (axis): horizontal-axis wind machines and vertical-axis wind machines. The size of wind machines varies widely. Small turbines used to power a single home or business may have a capacity of less than 100 kilowatts. Some large commercial sized turbines may have a capacity of 5 million watts, or 5 megawatts. Larger turbines are often grouped together into wind farms that provide power to the electrical grid.

### Vertical axis wind mills

- a) Savonius or S type wind mill (low wind velocity)
- b) Darrius wind mill (high wind velocity)

### Horizontal axis wind mills

- a) Single blade wind mills
- b) Double blade wind mills
- c) Multi blade wind mills

### Vertical axis wind mills

Vertical axis machines are of simple design as compared to the horizontal axis. The axis of rotation of vertical axis wind turbine is vertical to the ground and almost perpendicular to the wind direction. These turbines can receive wind from any direction. Hence complicated yaw devices can be eliminated. The generator and the gearbox of such systems can be housed at the ground level, which makes the tower design simple and more economical. Moreover, the maintenance of these turbines can be done at the ground level. The major disadvantage of vertical axis machines are that, these turbines usually not self-starting. Additional mechanism may be required to push and start the turbine.



## Vertical axis wind mills

### a) Savonius wind mill

It works on the principle of cup anemometer. This machine has become popular, since it requires low wind velocity for operation. It consists of two half cylinders, which are mounted on a vertical axis perpendicular to the direction of wind, with a gap at the axis between the two cylinders. Two half cylinders facing each other forming an s' shaped cross-section. Irrespective of the wind direction, the rotor rotates such as to make the convex sides of the buckets head into the wind. From the rotor shaft, we can tap power for our use like water pumping, battery charging, grain winnowing etc.

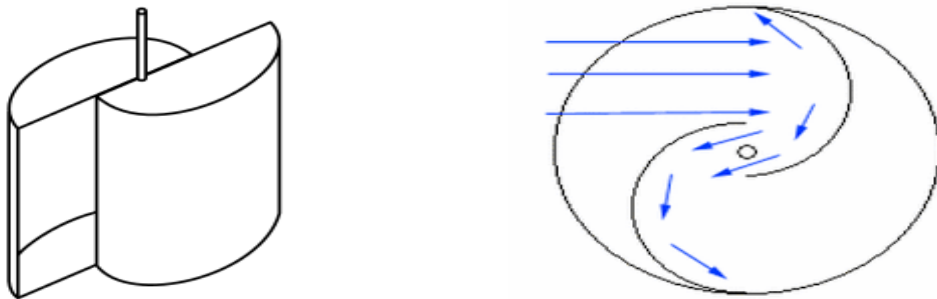

The main action of the wind is very simple, the force of the wind is greater on the cupped face than on rounded face. A low pressure is created on the convex sides of drums. Torque is produced by the



pressure difference between the two sides of the half cylinders facing the wind.

This design is efficient but requires a large surface area. A savonius wind energy conversion system has a vertical axis which eliminate the expensive power transmission system from the rotor to the axis. Since it is a vertical axis machine it does not matters much about the wind direction. The machine performs even at lower wind velocity ranges (i.e., 8 kmph).

### b) Darrieus wind mill

Added advantage with this mill is that it supports its blades in such a way that minimizes bending stresses in normal operation. It requires less surface area as compared to Savonius type. In this machine, the blades are curved and attached to the hubs on the vertical shaft at both ends to form a cage-like structure. The blades look like an egg beater. Darrieus rotors have three symmetrical aerofoil blades, both ends of which are attached to a vertical shaft. Thus, the force in the blade due to rotation is pure tension. This provides a stiffness to withstand the wind forces it experiences.

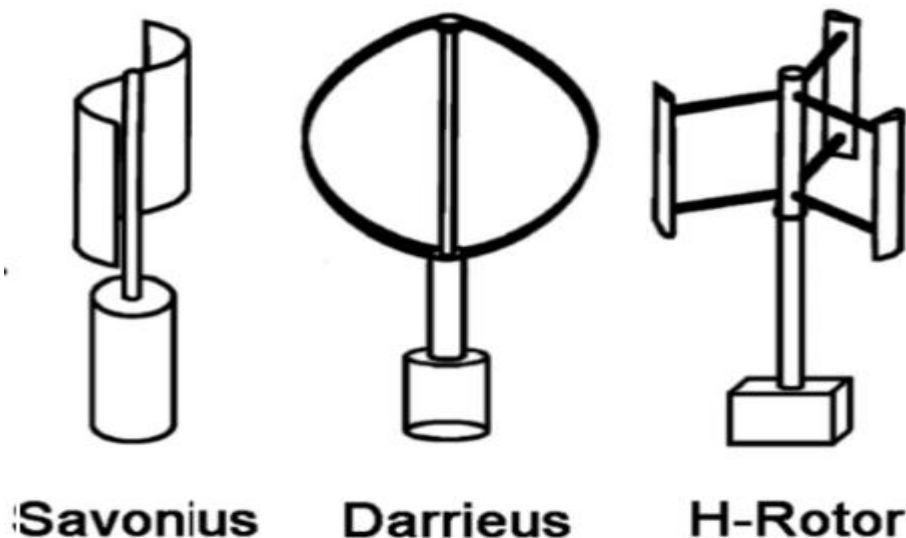

The blades are made lighter than in the propeller type. When rotating, these aerofoil blades provide a torque about the central shaft in response to a wind direction. This shaft torque is transmitted to a generator at the base of the central shaft for power generation. Both Savonius and darrieus type rotors run independently of the direction of wind because they rotate about a

vertical axis. Major advantage of darrieus wind mill is that the rotor blades can accept the wind from any point of the compass. The machine can be mounted on the ground eliminating the tower structures. Disadvantage is that, it may experience lower velocity wind when compared to tower mounted conventional wind energy conversion system.

## Horizontal axis type wind mills

Horizontal axis wind turbines have their axis of rotation horizontal to the ground and almost parallel to the wind stream. Most of the commercial wind turbines fall under this category. Horizontal axis machines have some distinct disadvantages such as low cut-in speed and easy furling. In general, they show relatively high power coefficient. However, the generator and gearbox of these machines are to be placed over the tower which makes its design more complex and expensive. Depending on the number of blades, horizontal axis wind turbines are further classified as single bladed, two bladed, three bladed and multi bladed.

The horizontal type wind mills have thin cross-section or more efficient thick cross- section of aerofoil blade. The blade is designed such that the tip of the blades makes a small angle with the plane of rotation and almost at right angles to the direction of wind. In a modern wind turbine, the velocity of blades is six times the wind velocity. Ideally, the blade should be twisted, but because of construction difficulties this is not always achieved. The horizontal axis wind mills generally have better performance. These are mainly used for electric power generation and pumping water



## Horizontal Axis Wind Turbine Construction and Working

**horizontal axis wind turbine components** mainly include foundation, nacelle, generator, tower, and rotor blades. Horizontal axis wind turbines include the rotor shaft & electric generator which are arranged at the top of the tower. Small wind turbines use a simple wind vane, whereas larger wind turbines use wind sensors that are connected through an auxiliary motor.

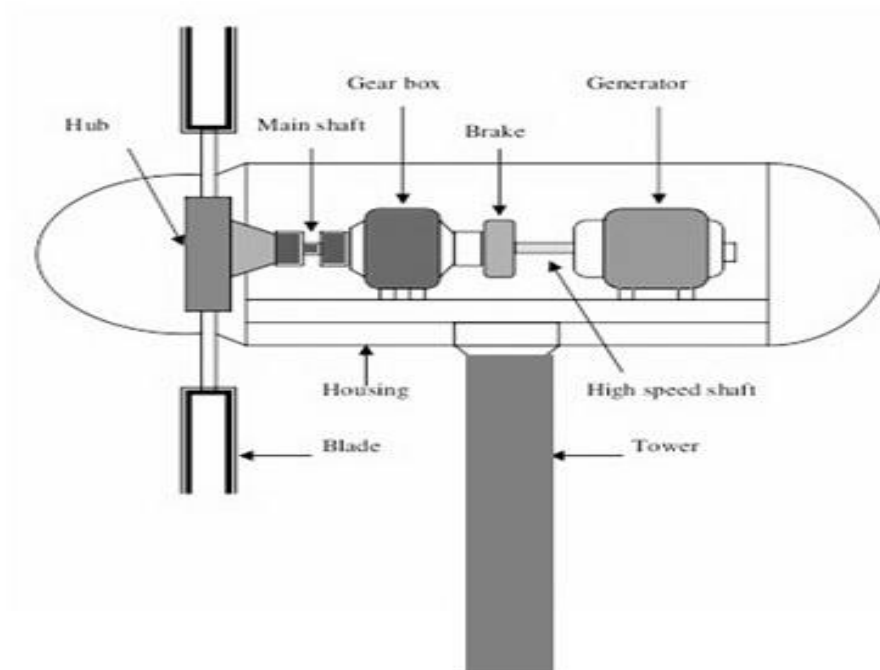

## Foundation

For any wind turbine, the foundation gives support to the tower because the wind turbine includes different parts which weigh in tonnes.

## Tower

A tower is used to give support to the rotor hub and nacelle on the top of the wind turbine. The materials used to make this are concrete, tubular steel, or steel lattice

## Wind Turbine Blades

These blades are mainly used to remove the kinetic energy (KE) of wind & change it to mechanical energy. These types of blades are designed with wood-epoxy or fiberglass-reinforced polyester. These turbines include a minimum of one and maximum multiple blades depending on the design.

Most of the horizontal axis wind turbines include three blades that are connected to the rotor hub. In earlier days, multiple blades based turbines are used as a single blade, two-blade and three blades for grinding & pumping water, etc.

## Nacelle

The nacelle includes different components which are used to operate the wind turbine efficiently like the gearbox, brakes, controller, low & high-speed shafts & generator. It is arranged at the top of a tower & a wind vane is arranged on the nacelle.

## Hub

A rotor hub is used to connect a shaft and rotor blade of the wind turbine. The hub includes blade bearings, bolts, internals & a pitch system. These are designed with cast iron, welded sheet steel & forged steel. These are available in two types like Hinge-less hub & Teetering hub.

## Gear Box

In wind turbines, a gearbox is used to change high torque power with low-speed which is received from a rotor blade to low torque power with high speed. This power is used for the generator. The gearbox is connected in between the generator and main shaft for enhancing rotational speeds from 30 – 60 rpm to 1000 – 1800 rpm.

Gearboxes are made with different materials like superior quality alloys, aluminum cast iron, stainless steel, etc. In wind turbines, there are three types of gearboxes are used like Planetary, Helical, and Worm.

## Generator

The rotating mechanical energy of the gearbox is given to the generator through the shaft. It works on ‘Faraday’s law of electromagnetic induction principle. So it changes the energy from mechanical to electrical.

## Horizontal Axis Wind Turbine Working

Once the wind blows, a wind turbine changes the kinetic energy from the motion of the wind into mechanical through the revolution of the rotor. After that, this converted energy can be transmitted through the shaft & the gear train toward the generator. Further, this generator converts the energy from mechanical to electrical to generate electricity.

The wind flows on both faces of the airfoil-shaped blade although flows faster on the upper face of the airfoil to create a low-pressure region on the airfoil. The pressure difference between both the top & bottom surfaces results within the aerodynamic lift.

As the blades of a wind turbine are constrained to move in a plane with the hub as the center, the lift force causes rotation about the hub. In addition to the lift force, a drag force perpendicular to the lift force prevents rotor rotation.

The horizontal axis wind turbine design mainly includes a high lift to drag ratio, especially for the blades. So this ratio can change through the blade’s length to optimize the output energy for the wind turbine at different speeds of wind. The generator & rotor shaft are arranged within the box at the top of the array.

## Advantages and Disadvantages

The **advantages of a horizontal axis wind turbine** include the following.

- It includes high output power as compared to the vertical wind turbine.
- A tall tower gets stronger winds once the wind shear alters.
- High efficiency.
- It is not expensive as compared to vertical type turbine.
- It has high reliability.
- It has a high rate of capacity.
- Its rotational speed is high.
- It is more consistent.
- These turbines are self-starting.
- In this turbine, the vanes are located one face of the turbine center of gravity, which improves stability.
- It can bend the blades so that the turbine blades have the best attack angle.
- The blade can also tilt the rotor during a storm to reduce damage

The **disadvantages of horizontal axis wind turbine** include the following.

- These are available in large size.
- Weight is high.
- We cannot move easily.
- Installation is difficult.
- High noise.
- To design this wind turbine, large machinery is needed.
- Its maintenance is difficult as compared to other wind turbines.

## Applications

The **applications of horizontal axis wind turbines** include the following.

- These are the most frequently used wind turbines for commercial and industrial purposes due to their large power output and high efficiency.
- These are mostly used in wind farms
- Horizontal axis wind turbines achieve better power output & higher energy efficiency, so used in large-scale wind power plants & also for electricity generation.

- In industrial plants, large-scale wind farms, or national projects, these wind turbines are most frequently seen. So they are the perfect solution for the production of mass electricity.

### Vertical Axis Wind Turbine Construction

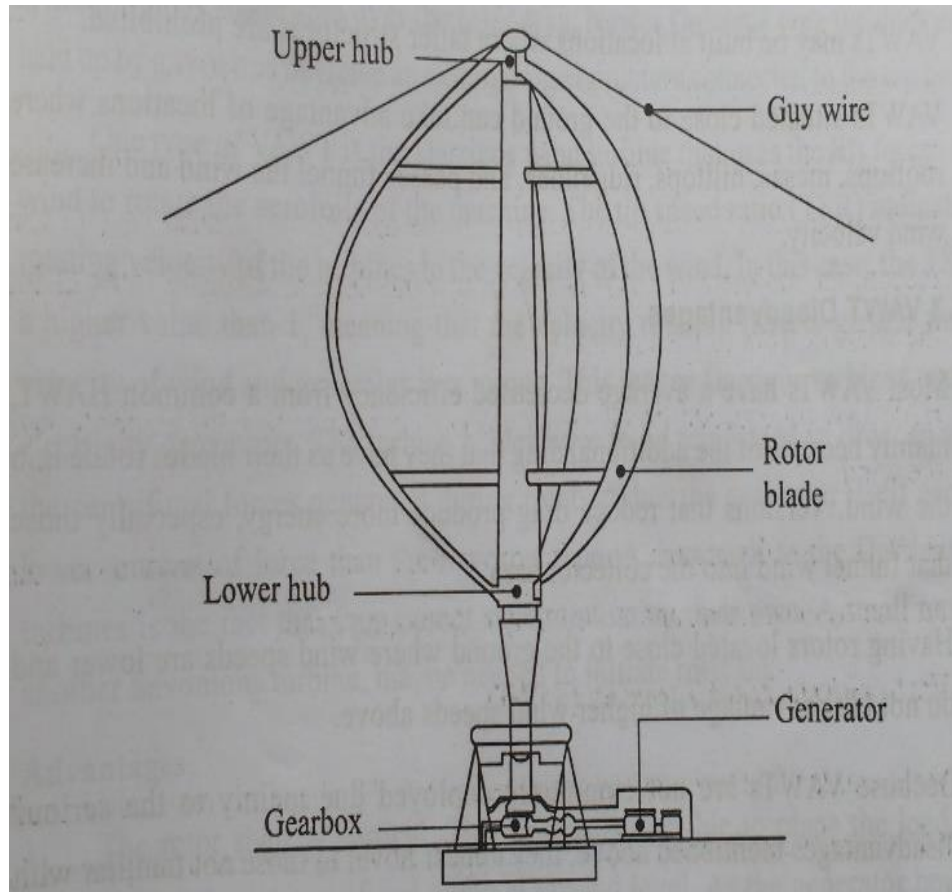

In this type of wind turbine, the axis of rotation is vertical. The sails or blades may also be vertical. Vertical axis wind turbines are a type of wind turbine where the main rotor shaft is set transverse to the wind (but not necessarily vertically) while the main components are located at the base of the turbine. This arrangement allows the generator and gearbox to be located close to the ground, facilitating service and repair.

## Construction of Vertical Axis Wind Turbine

Mechanical and electrical components:

1. Rotor (blades and connection items)
2. Braking system
3. Generator
4. Control system
5. Tower.

### Gear Box

The gearbox, located between the rotor and the generator, **turns the slow rotation of the blades into a quicker rotation that is more suitable to drive an electrical generator**. On average, while the rotor turns at a 20 rpm speed, the generator requires 1000 rpm to generate electricity.

### Rotor (blades and connection items)

Its function is to produce aerodynamic efficiency. It is constituted of light but resistant material and it is provided with a protective layer.

### Braking system

Its function is to stop the rotor motion in adverse weather conditions. It is constituted of [disc brakes](#) similar to those of cars and of friction brakes which function in case of failure of the electrical grid.

### Tower

It has to withstand the action of wind and the weight of the blades. It is generally tabular, or trellis and the base can be either superfield or deep.



## Working of Vertical Axis Wind Turbine

In this types of wind turbine, the blades are aerofoil shape, and it can take the wind from any direction. The rotor is not self-starting. The rotor is supported by a system of guy cables. The base of the wind turbine rotor is coupled to a generator by a drive flexible coupling. Here the blades rotate around a vertical axis.

A wind turbine captures high-pressure wind, and it causes kinetic energy. This kinetic energy is converted into mechanical energy, and mechanical energy is converted into electric power.

This generated electrical power is taken by the static frequency converter from the generator at a variable frequency (0 – 20 Hz) and supplies a constant frequency output (60 Hz), and feeds to the grid. The static frequency converter is controlled by a microprocessor-based control system.

## Advantages of Vertical Wind Turbines

1. More of these types of turbines can be installed on the same amount of land because as the wind passes through them, not as much turbulence is created.
2. Due to the orientation of these devices, the entire pole or shaft can be turned which makes it possible to mount the generator and other mechanisms at ground level. This makes maintenance work relatively easier.
3. VAWT's don't have to point into the wind to start up.
4. Devices with this type of design are more muscular than horizontally oriented units. Because they do not have to go in the air, they do not need a tail section to keep the rotor blade assembly on the airside. During gusty wind conditions, these units are less likely to sustain damage than traditionally designed units.
5. They don't need as much wind to generate power which means they can be installed closer to the ground.
6. The vertical orientation of the blades often results in these devices being quieter than standard turbines.
7. Since tall towers aren't necessary, installation and maintenance costs are reduced.

## Disadvantages of Vertical Wind Turbine

Following are the disadvantages of vertical wind turbines:

1. While this design is less likely to be damaged by gusty wind conditions, they are more likely to stall out and stop spinning.
2. These types of turbines aren't typically well suited for use in areas of high wind speeds.
3. Due to the vertically oriented blade design, the blades flex and turn faster and faster as the rotor assembly. The centrifugal force generated by the spinning blade has been reported to cause stress and fatigue on some blade designs, which sometimes results in them breaking.

## CHAPTER-4

### BIOMASS

#### Biomass

Plant matter created by the process of photosynthesis is called biomass (or) all organic materials such as plants, trees and crops are potential sources of energy and are collectively called biomass. The term biomass is also generally understood to include human waste, and organic fractions of sewage sludge, industrial effluents and household wastes. The biomass sources are highly dispersed and bulky and contain large amounts of water (50 to 90%). Thus, it is not economical to transport them over long distances, and conversion into usable energy must take place close to source, which is limited to particular regions.

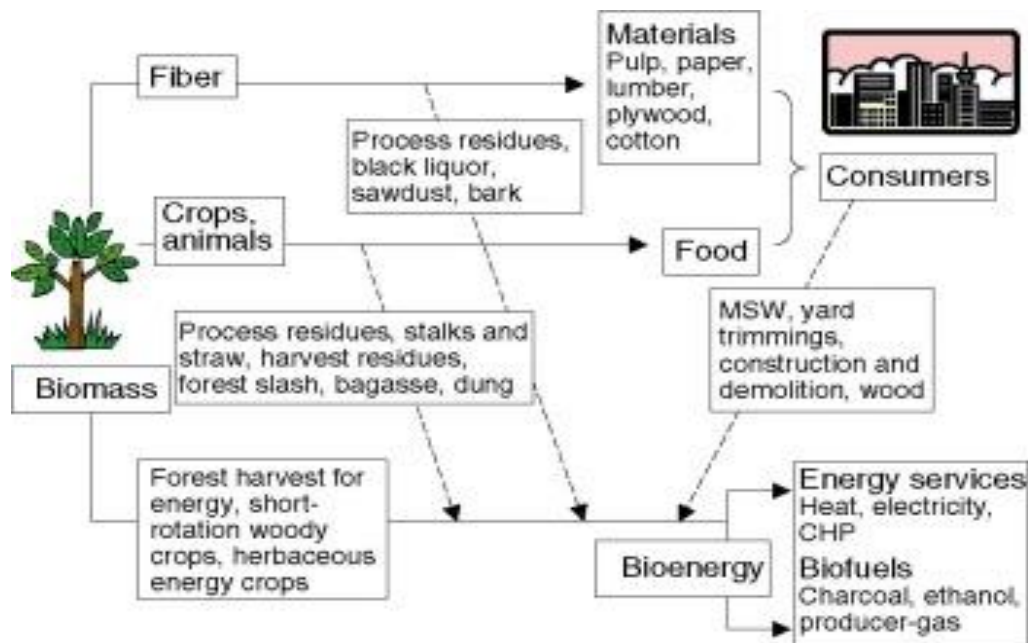

Schematic diagram of utilization of biomass

## Biomass Conversion

Biomass can either be utilized directly as a fuel, or can be converted into liquid or gaseous fuels, which can also be as feedstock for industries. Most biomass in dry state can be burned directly to produce heat, steam or electricity. On the other hand biological conversion technologies utilize natural anaerobic decay processes to produce high quality fuels from biomass. Various possible conversion technologies for getting different products from biomass is broadly classified into three groups

(i) thermo-chemical conversion, (ii) bio-chemical conversion and (iii) oil extraction.

Thermo-chemical conversion includes processes like combustion, gasification and pyrolysis. Combustion refers to the conversion of biomass to heat and power by directly burning it, as occurs in boilers. Gasification is the process of converting solid biomass with a limited quantity of air into producer gas, while pyrolysis is the thermal decomposition of biomass in the absence of oxygen. The products of pyrolysis are charcoal, condensable liquid and gaseous products.

Combustion, gasification and pyrolysis are all thermochemical processes to convert biomass into energy. In all of them, the biomass is heated to evaporate water and then to cause pyrolysis to occur and to produce volatiles.

Thermal conversion processes for biomass involve some or all of the following processes:

Pyrolysis: Biomass +heat	charcoal , gas and oil
Gasification: Biomass +limited oxygen	fuel gas
Combustion: Biomass +stoichiometric O <sub>2</sub>	hot combustion products

## Combustion

Combustion is a process whereby the total or partial oxidation of carbon and hydrogen converts the chemical energy of biomass into heat. This complex chemical reaction can be briefly described as follows:

Burning fuel = Products from reaction + heat

During the combustion process, organic matter decomposes in phases, i.e. drying, pyrolysis/gasification, ignition of volatile substances and charcoal combustion. Generally speaking, these phases correspond to two reaction times: release of volatile substances and respective combustion, followed by charcoal combustion.

Wood, agricultural residues, wood pulping liquor, municipal solid waste (MSW) and refuse derived fuel are examples of feed stocks for combustion. Combustion requires high temperatures for ignition, sufficient turbulence to mix all of the components with the oxidant, and time to complete all of the oxidation reactions. The moisture content of the feedstock should be low and pre-drying may be necessary in some cases.

Biomass combustion starts by heating and drying the feedstock. After all of the moisture has been removed, temperature rises for pyrolysis to occur in the absence of oxygen. The major products are hydrogen, CO, CO<sub>2</sub>, CH<sub>4</sub> and other hydrocarbons. In the end, char and volatile gases are formed and they continue to react independently. The volatile gases need oxygen in order to achieve a complete flame combustion. Mostly CO<sub>2</sub> and H<sub>2</sub>O result from complete combustion. When combusting biomass in a furnace, hot gases are released. They contain about 85% of the fuel's potential energy. The heat can be used either directly or indirectly through a heat exchanger, in the form of hot air or water. Boiler used for biomass combusting transfers the produced heat into steam. The steam can be used for producing electricity, mechanical energy or heat.

## **Gasification**

Gasification is a process whereby organic matter decomposes through thermal reactions, in the presence of stoichiometric amounts of oxidising agents. The process generates a combustible gas mix, essentially composed of carbon monoxide, hydrogen, carbon dioxide, methane, steam and, though in smaller proportions, other heavier hydrocarbons and tars. The process is aimed at converting the energy potential of a solid fuel into a gas product, whose energy content has the form of chemical energy with the capacity to generate work.

Gasification is carried out in two steps. First, the biomass is heated to around 600 degrees. The volatile components, such as hydrocarbon gases, hydrogen, CO, CO<sub>2</sub>, H<sub>2</sub>O and tar, vaporize by various reactions. The remaining by-products are char and ash. For this first endothermic step, oxygen is not required. In the second step, char is gasified by reactions with oxygen, steam and hydrogen in high temperatures. The endothermic reactions require heat, which is applied by combusting some of the unburned char. Main products of gasification are synthesis gas, char and tars. The content depends on the feedstock, oxidizing agent and the conditions of the process. The gas mainly consists of CO, CO<sub>4</sub>, H<sub>2</sub>O, CH<sub>4</sub> and other

hydrocarbons. The synthesis gas can be utilized for heating or electricity production. It can also be used for the production of ethanol, diesel and chemical feed stocks.

## **Pyrolysis**

In pyrolysis, biomass is heated in the absence of air. The process results liquid, solid and gaseous fractions, mainly gases, bio-oil and char. The gases and the bio-oil are from the volatile fraction of biomass, while the char is mostly the fixed carbon component. In the first step, temperature is increased to start the primary pyrolysis reactions. As a result, volatiles are released and char is formed. Finally, after various reactions, pyrolysis gas is formed. The main product of slow pyrolysis, a thousands of years old process, is char or charcoal. In slow pyrolysis biomass is heated to around 500 degrees for 5 to 30min. Fast pyrolysis results mainly in bio-oil. The biomass is heated in the absence of oxygen and the residence time is 0, 5 to 5s. Vapours, aerosols and char are generated through decomposition. After cooling, bio-oil is formed. The remaining non condensable gases can be used as a source of energy for the pyrolysis reactor. Calculated by weight, fast pyrolysis results in 60%-75% liquid bio-oil, 15%-25% solid char, and 10%-20% non-condensable gases.

### **5.1 Gasifiers**

Gasification of wood and other agricultural cellulosic residues was a common practice at the beginning of this century to produce low calorie fuel gas. Gasifiers can be suitably used for thermal decomposition of a wide range of feed materials from forestry products, agricultural residues, and aquatic biomass to municipal solid wastes.

However, some important points which should be taken into consideration while undertaking any biomass gasification system:

- A gasifier itself is of little use. It is used either to generate a combustible gas to provide heat or to generate a fuel gas which can be used in an internal combustion engine as a petroleum oil substitute.
- Some of the gaseous, liquid and solid products of combustion are not only harmful to engines and burners, but also to human beings. That is why these gases are not used as cooking gas.
- A gasifier must have an effective gas cleaning train if the gas is to be used for internal combustion engines. A maximum limit of 5-15 mg solids and tar per kg of gas may be allowed for the use of the gas in an internal combustion engine.

A gasification system may not be of much advantage to generate a combustible gas, as far as fossil fuel savings, economies and ease of operation are concerned.

## Biogas:

Most organic materials undergo a natural anaerobic digestion in the presence of moisture and absence of oxygen and produce biogas. The biogas so obtained is a mixture of methane (CH<sub>4</sub>): 55-65% and Carbon dioxide (CO<sub>2</sub>) : 30-40%. The biogas contains traces of H<sub>2</sub>, H<sub>2</sub>S and N<sub>2</sub>. The calorific value of biogas ranges from 5000 to 5500 Kcal/Kg (18.8 to 26.4 MJ /m<sup>3</sup>).

Digestion is biological process that occurs in the absence of oxygen and in the presence of anaerobic organisms at temperatures (35-70°C) and atmospheric pressure. The container in which, this process takes place is known as digester.

### Types of biogas plants

Biogas plants basically are two types

#### **Floating dome type**

- The floating-drum plant with a cylindrical digester (KVIC model)

#### **Fixed dome type**

- The fixed-dome plant with a brick reinforced, moulded dome (Janata model)
- The fixed-dome plant with a hemisphere digester (Deenbandhu model)

#### **Floating dome type**

Floating-drum plants consist of an underground digester and a moving gas-holder. The gas-holder floats either directly on the fermentation slurry or in a water jacket of its own. The gas is collected in the gas drum, which rises or moves down, according to the amount of gas stored. The gas drum is prevented from tilting by a guiding frame. If the drum floats in a water jacket, it cannot get stuck, even in substrate with high solid content.

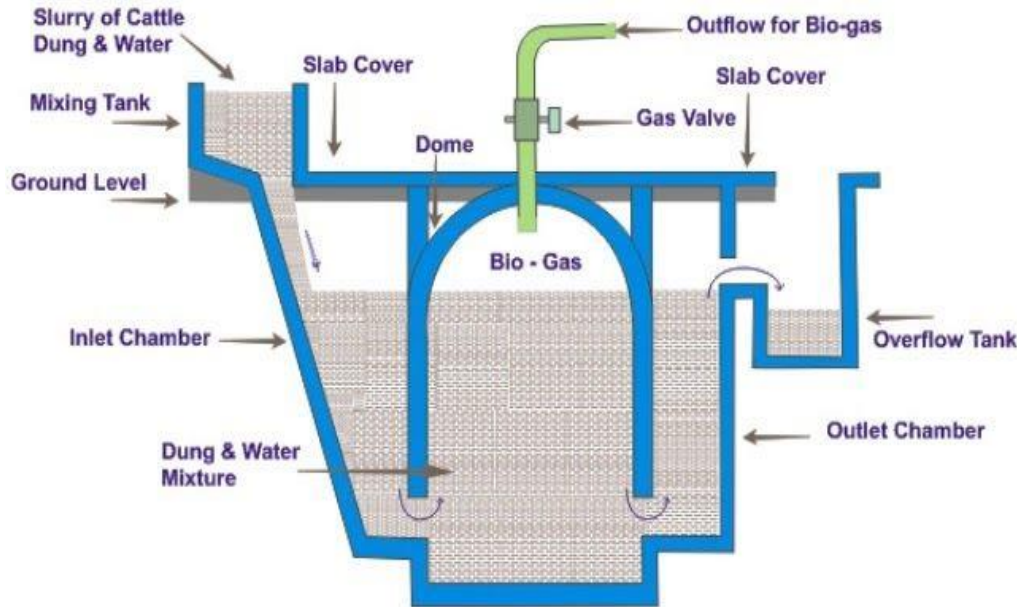

### Fixed Dome type Bio-gas Plant

**Drum:-**In the past, floating-drum plants were mainly built in India. A floating-drum plant consists of a cylindrical or dome-shaped digester and a moving, floating gas-holder, or drum. The gas-holder floats either directly in the fermenting slurry or in a separate water jacket. The drum in which the biogas collects has an internal and/or external guide frame that provides stability and keeps the drum upright. If biogas is produced, the drum moves up, if gas is consumed, the gas-holder sinks back.

**Size:-**Floating-drum plants are used chiefly for digesting animal and human feces on a continuous feed mode of operation, i.e. with daily input. They are used most frequently by small- to middle-sized farms (digester size: 5-15m<sup>3</sup>) or in institutions and larger agro-industrial estates (digester size: 20-100m<sup>3</sup>).

### KVIC type biogas plant

This mainly consists of a digester or pit for fermentation and a floating drum for the collection of gas. Digester is 3.5-6.5 m in depth and 1.2 to 1.6 m in diameter. There is a partition wall in the center, which divides the digester vertically and submerges in the slurry when it is full. The digester is connected to the inlet and outlet by two pipes. Through the inlet, the dung is mixed with water (4:5) and loaded into the digester. The fermented material will flow out through outlet pipe. The outlet is generally connected to a compost pit. The gas generation takes place slowly and in two stages. In the first stage, the complex, organic substances contained in the waste are acted upon by a certain kind of bacteria, called acid formers and broken up into small-chain simple acids. In the second stage, these acids are acted upon by another kind of



bacteria, called methane formers and produce methane and carbon dioxide.

**Gas holder :-**The gas holder is a drum constructed of mild steel sheets. This is cylindrical in shape with concave. The top is supported radically with angular iron. The holder fits into the digester like a stopper. It sinks into the slurry due to its own weight and rests upon the ring constructed for this purpose. When gas is generated the holder rises and floats freely on the surface of slurry. A central guide pipe is provided to prevent the holder from tilting. The holder also acts as a seal for the gas. The gas pressure varies between 7 and 9 cm of water column. Under shallow water table conditions, the adopted diameter of digester is more and depth is reduced. The cost of drum is about 40% of total cost of plant. It requires periodical maintenance. The unit cost of KVIC model with a capacity of 2 m<sup>3</sup>/day costs approximately Rs.14, 000.

### Fixed-dome type plants

A fixed-dome plant consists of a digester with a fixed, non-movable gas holder, which sits on top of the digester. When gas production starts, the slurry is displaced into the compensation tank. Gas pressure increases with the volume of gas stored and the height difference between the slurry level in the digester and the slurry level in the compensation tank

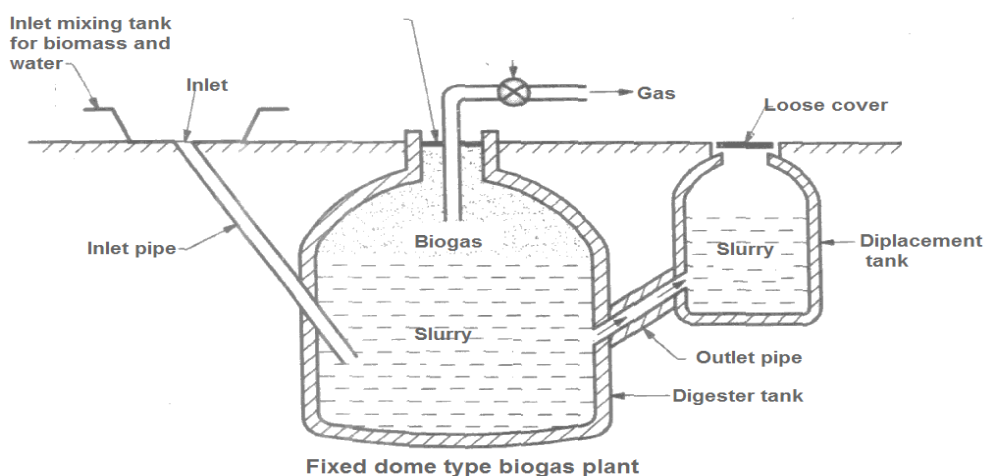

**a) Function** - A fixed-dome plant comprises of a closed, dome-shaped digester with an immovable, rigid gas-holder and a displacement pit, also named 'compensation tank'. The gas is stored in the upper part of the digester. When gas production commences, the slurry is displaced into the compensating tank. Gas pressure increases with the volume of gas stored, i.e. with the height difference between the two slurry levels. If there is little gas in the gas-holder, the gas pressure is low.

**b) Digester** - The digesters of fixed-dome plants are usually masonry structures, structures of cement and ferro-cement exist. Main parameters for the choice of material are:

- Technical suitability (stability, gas- and liquid tightness)
- Cost-effectiveness
- Availability in the region and transport costs
- Availability of local skills for working with the particular building material.

Fixed dome plants produce just as much gas as floating-drum plants, if they are gas-tight. However, utilization of the gas is less effective as the gas pressure fluctuates substantially. Burners and other simple appliances cannot be set in an optimal way. If the gas is required at constant pressure (e.g., for engines), a gas pressure regulator or a floating gas-holder is necessary.

**C) Gas Holder** - The top part of a fixed-dome plant (the gas space) must be gas-tight. Concrete, masonry and cement rendering are not gas-tight. The gas space must therefore be painted with a gas-tight layer (e.g. 'Water-proofer', Latex or synthetic paints). A possibility to reduce the risk of cracking of the gas-holder consists in the construction of a weak-ring in the masonry of the digester. This "ring" is a flexible joint between the lower (water-proof) and the upper (gas-proof) part of the hemispherical structure. It prevents cracks that develop due to the hydrostatic pressure in the lower parts to move into the upper parts of the gas-holder.

## Biodiesel

It is an alternative fuel similar to conventional or „fossil“ diesel. Its primary advantages are that it is one of the most renewable fuels currently available and it is also non-toxic and biodegradable. It can also be used directly in most diesel engines without requiring extensive engine modifications. Biodiesel can be produced from straight vegetable oil, animal oil/fats, tallow and waste cooking oil. The largest possible source of suitable oil comes from oil crops such as rapeseed, palm or soybean. Most biodiesel produced at present is produced from waste vegetable oil sourced from restaurants, chip shops, industrial food producers such as Birdseye etc. Though oil straight from the agricultural industry represents the greatest potential source it is not being produced commercially simply because the raw oil is too expensive.

After the cost of converting it to biodiesel has been added on it is simply too expensive to compete with fossil diesel. Waste vegetable oil can often be sourced for free or sourced already treated for a small price. (The waste oil must be treated before conversion to biodiesel to remove impurities). The result is Biodiesel produced from waste vegetable oil can compete with fossil diesel.

## Significance of biodiesel

- It is a processed fuel resulting from the biological sources and it is equivalent to petro-diesel
- Biodiesel acts as a safe alternative fuel for substituting traditional petroleum diesel. It is a clean burning fuel with high lubricity
- It is produced from renewable sources acts like petroleum diesel but produces significantly less air pollution
- It is bio-degradable and very safe for the environment
- Biodiesel production can be achieved in different methods. Biodiesel is a mono alkyl ester of fatty acids produced from both edible and non edible vegetable oils or animal fat and various other bio fuels such as methanol, ethanol etc.

**CHAPTER:****5****OCEAN THERMAL ENERGY CONVERSION TECHNOLOGY (OTEC):**

- OTEC plant can operate on open and closed cycles.
- In an open cycle plant warm water from the ocean surface is flash evaporated under partial vacuum. Low –pressure steam obtained is separated and passed through a turbine to extract energy.
- The exhaust of the turbine is condensed in a direct contact condenser; cold water drawn from the depth of about 1000 m is used as cooling water in a direct contact condenser. The resulting mixture of used cooling water and condensate is disposed in the sea.
- If a surface contact condenser is employed, the condensate is employed; the condensate could be used as desalinated water. Thus an open-loop OTEC plant can provide a substantial quantity of desalinated water.

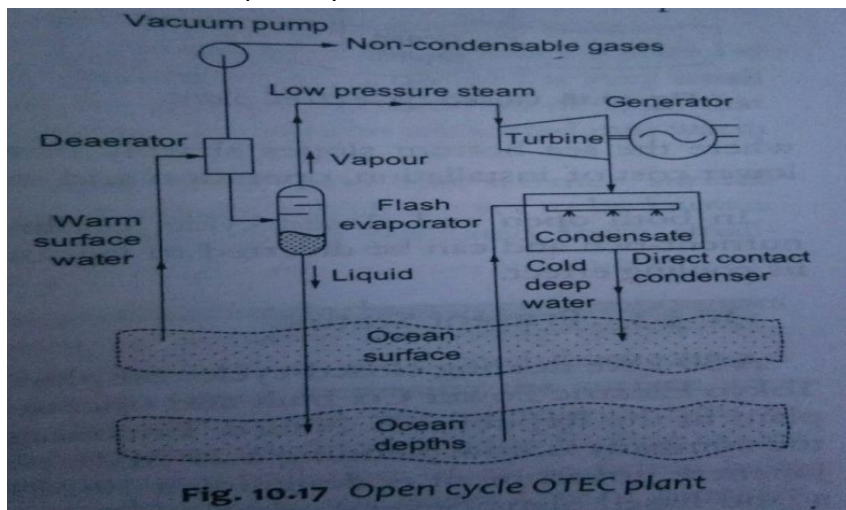

- In a closed cycle plant, warm surface water is used to evaporate a low boiling point working fluid such as ammonia, propane. The vapour flow through the turbine and is then cooled and condensed by cold water pumped from the ocean depth. Because of the low quality of the heat, large surface area of heat exchanger are required to transfer significant amount of heat and a large amount of water needs to be circulated.
- The operating pressure of the working fluid at the boiler or evaporator and condenser are much higher and its specific volume is much lower as compared to that in an open cycle system.

- Both open & close cycle plants can be mounted on a ship or built on shore. The ship option require submarine power cable for power transport, if the plant is located far from the shore, the transmission cost becomes prohibitive.

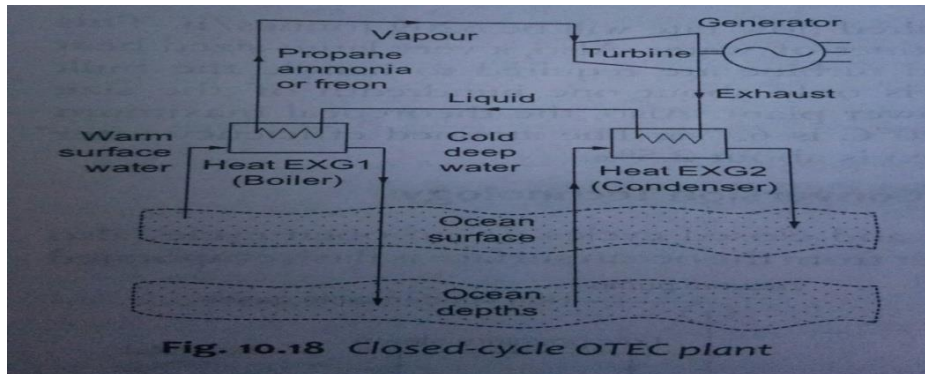

Fig. 10.18 Closed-cycle OTEC plant

## HYBRID POWER SYSTEMS

### Introduction:

The renewable energy technologies include power generation from renewable energy sources, such as wind, PV(photovoltaic), MH (micro hydro), biomass, ocean wave, geothermal and tides. In general, the key reason for the deployment of the above energy systems are their benefits, such as supply security, reduced carbon emission, and improved power quality, reliability and employment opportunity to the local people. Since the RE resources are intermittent in nature therefore, hybrid combinations of two or more power generation technologies, along with storage can improve system performance. Hybrid Renewable Energy System (HRES) combines two or more renewable energy resources with some conventional source (diesel or petrol generator) along with storage, in order to fulfill the demand of an area.

### Need for Hybrid Systems:

As convention fossil fuel energy sources diminish and the world's environmental concern about acid deposition and global warming increases, renewable energy sources (solar, wind, tidal, biomass and geothermal etc) are attracting more attention as alternative energy sources. These are all pollution free and one can say eco friendly. These are available at free of cost in India, there is severe power shortage and associated power quality problems. The quality of the grid supply in some places is

characterized by large voltage and frequency fluctuations, scheduled and un-scheduled power cuts and load restrictions. Load shedding in many cities in India due to power shortage and faults is a major

problem for which there is no immediate remedy in the near future since the gap between the power demand and supply is increasing every year. In India wind and solar energy sources are available all over the year at free of cost whereas tidal and wave are coastal area. Geothermal is available at specific location. To meet the demand and for the sake of continuity of power supply, storing of energy is necessary. The term hybrid power system is used to describe any power system combine two or more energy conversion devices, or two or more fuels for the same device, that when integrated, overcome limitations inherent in either.

### TYPE OF HYBRID SYSTEMS:

#### Wind/PV Hybrid System:

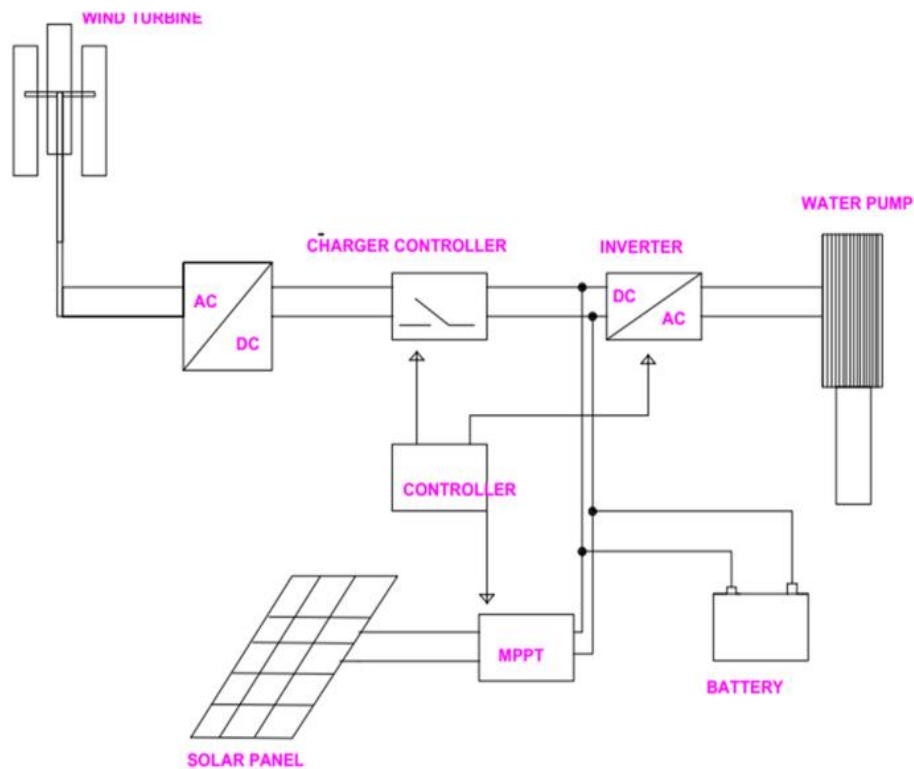

A typical hybrid energy system consists of solar and wind energy sources. The principle of an open loop hybrid system of this type is shown in Figure. The power produced by the wind generators is an AC voltage but have variable amplitude and frequency that can then be transformed into DC to charge the battery. The controller protects the battery from overcharging or deep discharging. As high

voltages can be used to reduce system losses, an inverter is normally introduced to transform the low DC voltage to an AC voltage of 230V of frequency 50 Hz.

The hybrid PV-wind generator system has been designed to supply continuous power of 1.5 kW and should have the following capabilities: Maximizes the electric power produced by the PV panels or by the wind generator by detecting and tracking the point of maximum power stores the electric energy in lead-acid batteries for a stable repeated operation. Control of the charge and discharge processes of the batteries protects wind generator from over speeding by connecting a dummy load to its output.

### PV/Hydro Hybrid System:

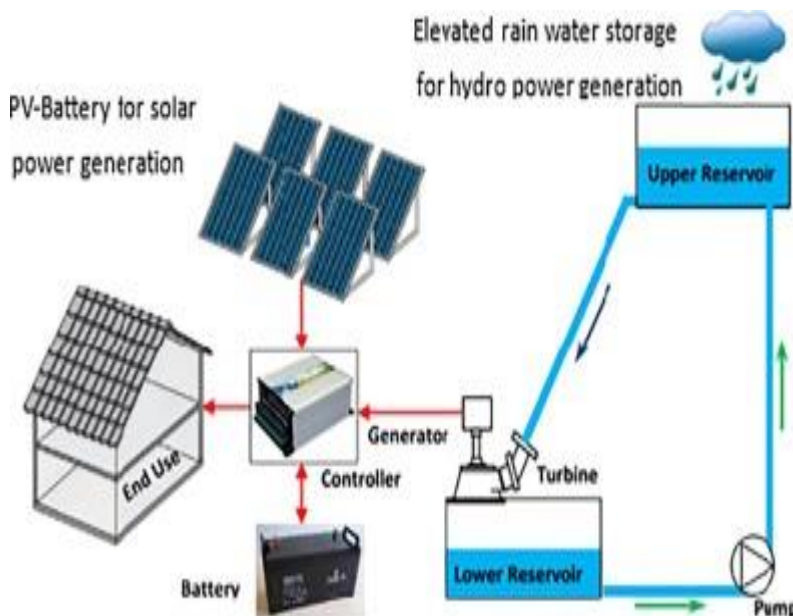

The block diagram of hybrid system, which combines PV with hydro system, is shown above. In this system there is a small reservoir to store the water. This type of hybrid system sometimes depends upon the geographical condition where the water at some height is available. System capacity is depends upon at the water quantity and solar radiation. The power supplied by falling water is the rate at which it delivers energy, and this depends on the flow rate and water head. The local water flow and head are limited at this project site, and a relatively simple hydro energy component is used in the project. Hydropower available is may be of runoff river type hence produces variable amplitude and frequency voltage. It can be used to charge the battery after converting it into DC.

### Hybrid PV diesel system:

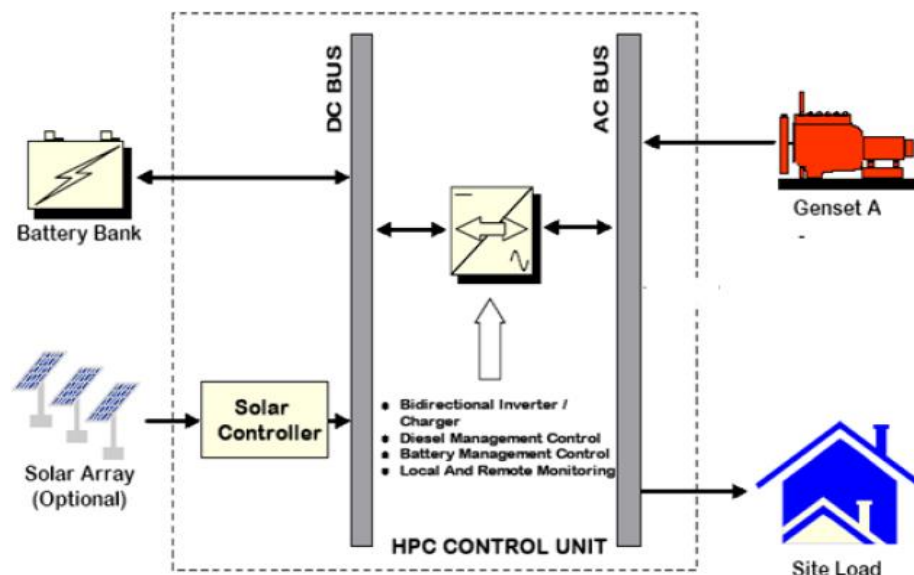

A photovoltaic diesel hybrid system ordinarily consists of a PV system, diesel gensets and intelligent management to ensure that the amount of solar energy fed into the system exactly matches the demand at that time. Basically the PV system complements the diesel gensets. It can supply additional energy when loads are high or relieve the genset to minimize its fuel consumption. In the future, excess energy could optionally be stored in batteries, making it possible for the hybrid system to use more solar power even at night. Intelligent management of various system components ensures optimal fuel economy and minimizes CO<sub>2</sub> emissions.

### **Advantages of a photovoltaic diesel hybrid system:**

In contrast to power supply systems using diesel gensets, and despite their higher initial cost, PV systems can be amortized in as little as four to five years, depending on the site and system size, and they have low operating costs. In addition, PV systems are flexible and can be expanded on a modular basis as the energy demand grows. Compared to pure gensets systems, a photovoltaic diesel hybrid system provides numerous advantages:

- Lower fuel costs
- Reduced risk of fuel price increases and supply shortages
- Minimal CO<sub>2</sub> .



References:

1. Energy Technology by S. Rao, Parulkar
2. Non-conventional source of energy by BH Khan, TMH Publication.
3. Renewable Energy sources And Emerging Technologies, DP. Kothari, PHI
4. Non-Conventional Sources of Energy- G.D.Rai, Khanna Publishers
5. Sudheer, K.P, Sureshkumar, P.K, Sreekutty Suresh V, and Greeshma, K. 2018. Lecture Notes of Renewable Energy