

**COURSE MATERIAL**  
**ADVANCE COMMUNICATION ENGINEERING**  
**6<sup>TH</sup> SEMESTER**  
**ELECTRONICS AND TELECOMMUNICATION ENGINEERING**



## **RADAR and Navigation Aids**

- RADAR is an electronic equipment used for detecting distant targets and measure its parameters such as range, speed, etc using radio frequency signal.
- RADAR is an electromagnetic system for detection and location of reflected high frequency signals from objects such as aircrafts, ships, vehicles, people and natural environment etc.
- It operates by transmitting a particular type of wave form (for e.g. pulse modulated sine wave) into space and detects the nature of echo signal reflected form an objects or targets.
- RADAR can't recognize colour of objects but it can recognize darkness, fog, smoke, rain, snow etc.
- RADARs are used in Different Fields like: -
  - Military
  - Remote Sensing
  - Air Traffic Control
  - Law Enforcement
  - Highway Safety
  - Aircraft Safety and Navigation
  - Ship Safety
  - Space Vehicles Control etc.

### **Un-Ambiguous Range:-**

- Once the signal is radiated into space by Radar, Sufficient time must elapse to allow all echo signals to return to the Radar before the next pulse is transmitted. The rate at which the next pulse transmitted is determined by the longest range at which targets are accepted.
- If the time between pulses TP is too short an echo signal from long range target might arrive after the transmission of next pulse and we mistakenly associated with that pulse rather than the actual pulse transmitted earlier. This can result an incorrect or ambiguous measurement of Range.
- Echo that arrives after the transmission of next pulse are called second-time around echo. Such an echo would appear to be at a closer range than the actual and its range measurement is called misleading, if it were not known to be second-time around echo.
- Hence the range beyond which the target appears as second-time around echo is called Maximum

- Unambiguous Range.  $R_{unamb} = CT_p/2 = C/2F_p$
- Where,  $T_p$  = Pulse Repetition Period. &  $F_p$  = Pulse Repetition Frequency.



### **RADAR Range Equation:**

Considering an Omni-directional antenna radiating power  $P_t$  :

The field intensity received at a distance  $R$  from the antenna is given by:

$$E = P_t / 4\pi R^2$$

Now, considering the antenna to be directional having a gain of  $G_t$ , the field intensity received at a distance  $R$  from the antenna is given by:

$$E = P_t G_t / 4\pi R^2$$

If the effective cross-section area of the target is given by  $\sigma$ , the field intensity reflected back by the target measured at the surface of the target is given by:

$$E = P_t G_t \sigma / 4\pi R^2$$

Now if the reflected signal is received back by the same transmitting antenna of effective aperture  $A_e$ , the field intensity received at the receiving station is given by:

$$E = P_t G_t \sigma A_e / (4\pi R^2)^2$$

Considering the receiver antenna gain to be  $G_r$ , the signal strength received at the receiving end is given by:

$$S = P_t G_t G_r \sigma A_e / (4\pi R^2)^2$$

Considering the limiting case for maximum range, the signal strength at the receiving terminal is the minimum detectable signal is given by:

$$S_{min} = P_t G_t G_r \sigma A_e / (4\pi R_{max}^2)^2$$

Hence the maximum range of a RADAR is given by:

$$R_{max} = (P_t G_t G_r \sigma A_e / 16\pi^2 S_{min})^{1/4}$$

So in order to increase the range of the RADAR by a factor of 2, the transmitter power to be increased by a factor of 16.

## Pulse RADAR:

The RADAR system which transmits the signal in form of short pulses to detect the range of the target is known as pulse radar. The following figure shows the block level concept of the working of pulse radar.

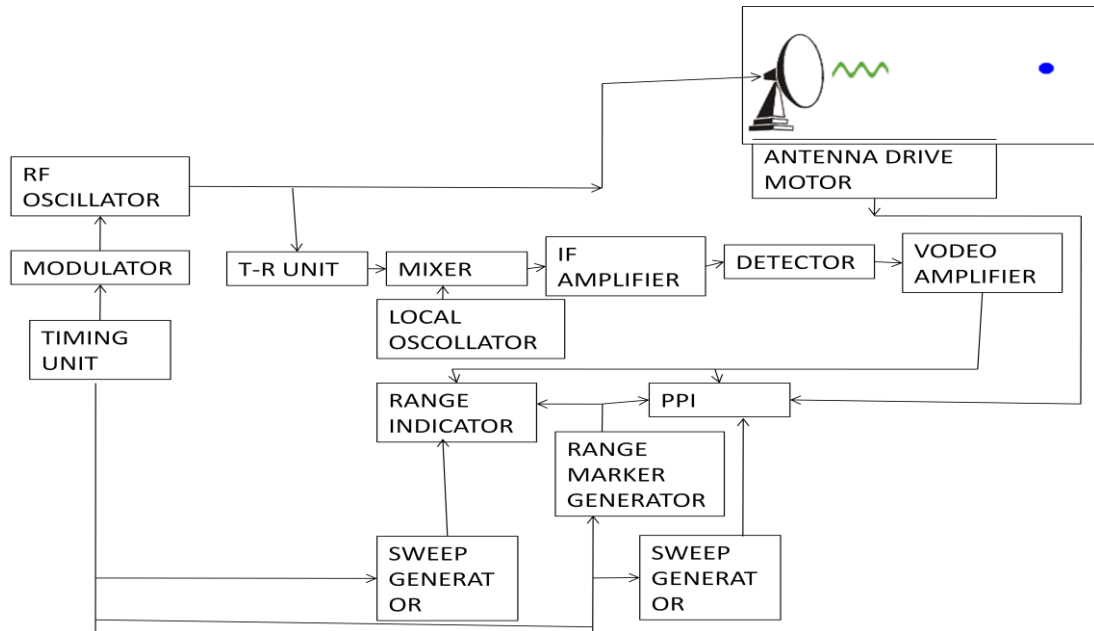

➤ It consist of three major section

- (1) Transmitter.
- (2) Receiver
- (3) Display unit
- (4) Transmission section

TRANSMITTER:-

- In the transmitter section, the high power oscillator that generates the RF energy is usually a magnetron.
- The energy bursts are obtained by a periodically application of high voltage pulses between the anode & cathode.
- The voltage pulses are formed in a modulator circuit, which determine the amplitude, duration & shape of the pulse.
- The pulse repetition frequency is commonly controlled by timing unit, which may consist of multi-vibrator or a blocking oscillator.
- Trigger pulses from the timing unit are also applied to various circuit in the indicator for the purpose of synchronization.

#### RECEIVER:-

- The radar receiver is of the super-heterodyne type with a mixer for frequency conversion as the I/P stage.
- A nonlinear device, consisting of a slab of crystalline material in contact with the tip of a wire is most effective at radar frequency for securing a favorable signal to noise ratio.
  - Generally a reflex klystron is used as the local oscillator.
  - Typical intermediate frequencies are 30 MHz & 60MHz.
  - Detection is accomplished by a conventional diode circuit.
- Video Amp. Following the detector raise the signal amplitude to an appropriate level for application to the indicator devices.

#### DISPLAY UNIT:-

- The display unit includes sweep generators for providing the beam deflection, that forms the time base for range measurement.
- These circuits are triggered by the pulses generated by the timing unit.
- To calibrate the distance along the time base accurately in terms of RADAR range, a range marker generator is often employed.
- This circuit produces a set of narrow pluses that forms a set of equally spaced vertical lines along the time base of range indicator and a set of dots along the time base of PPI. (Plan position Indicator).

#### TRANSMISSION SECTION:-

- The RF energy transmission section generally consists of rectangular waveguide or coaxial cables connecting the transmitter section to the Antenna.
- In the transmission section, the TR switch is used in order to isolate the receiver from transmitter channel during high power transmission & direct the received signal towards the receiver during reception.
- The TR switch generally consists of a rectangular shaped waveguide piece in which inert gasses are filled. During the transmission phase, due to the high power pulses, the gas is ionized & cuts off the receiver section.
- PRT – Pulse repetition time (formula)

$$\text{Radar range } R = \frac{CT}{2}$$

Where C = Speed of EM wave

T = Pulse repetition time

## Continuous Wave (CW) RADAR

- Continuous wave radar works on the principle of Doppler Effect in order to measure the relative target speed of the target with respect to the RADAR system.
- When the transmitted signal is reflected back from a moving target a small change in the transmitted signal frequency is observed at the receiver which may be processed in order to calculate the relative target speed.

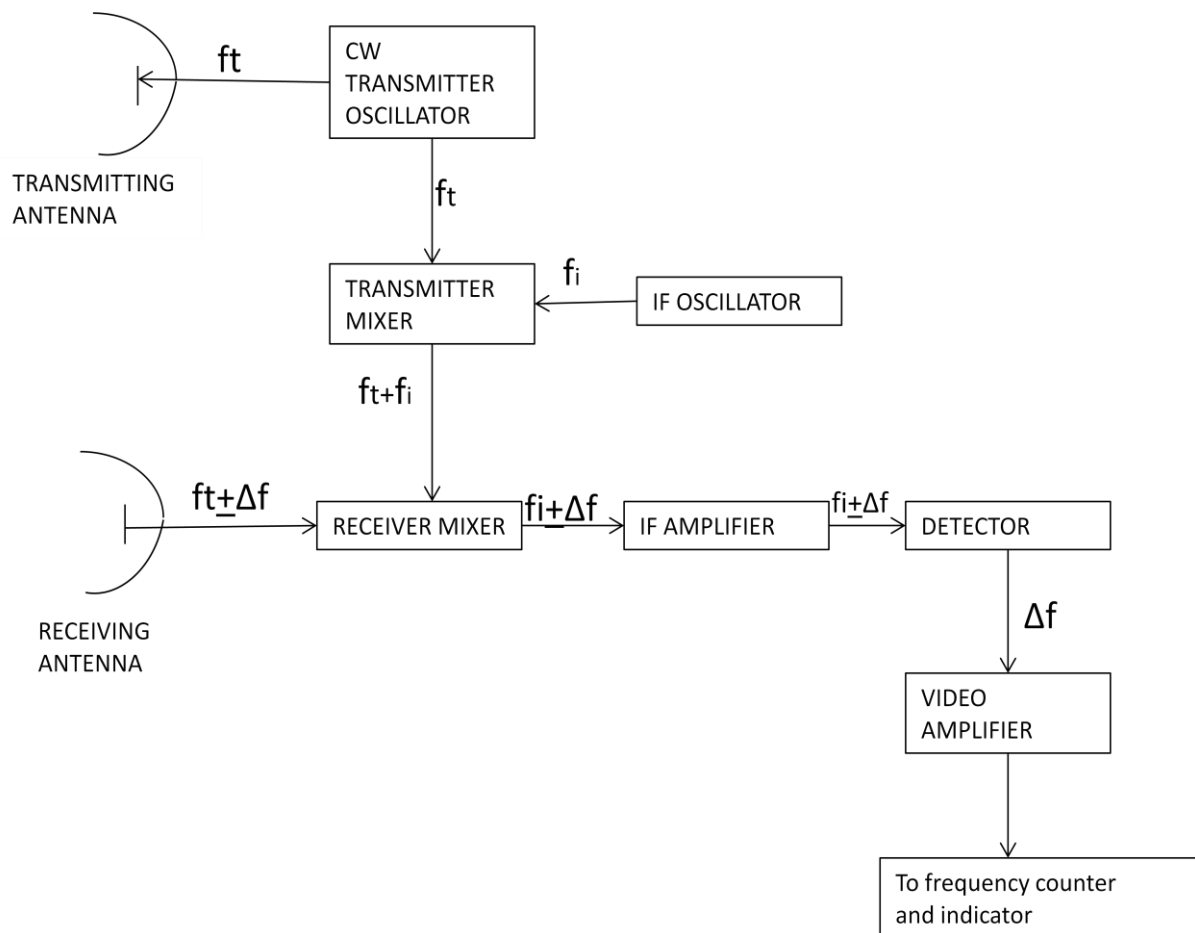

- The fig shows the block diagram of a CW radar.
- In this system continuous wave signal of frequency ' $f_t$ ' is transmitted through the transmitting antenna.
- A sample of the transmitter frequency mixed with the IF frequency is fed to the receiver channel.
- The Doppler shifted signal ( $f_t \pm \Delta f$ ) is received by the receiver antenna & fed to the receiver mixer.
- The receiver mixer cancels out the transmitted signal component and gives an o/p signal with frequency  $f_i \pm \Delta f$ .

- This if signal is amplified by the IF amp and subsequently the intermediate frequency signal is removed at the detector stage.
- The detector output is only having the Doppler shift component of the signal
- This signal is non directional. By using this Doppler shift the relative target speed may be calculated as follows.

$$\Delta f = \frac{2V}{\lambda} \text{ -----(1)}$$

Where  $\Delta f$ = Doppler shift frequency.

$V$ = Target speed.

$\lambda$  = Transmitted signal wave length

- We know that  $\lambda=c/f_t$  -----(2)

Where  $c$ = Velocity of electro

Magnetic wave in free space i.e  $3 \times 10^8$ sm/sec

$f_t$  = Transmitted signal frequency

- Putting the value of  $\lambda$  from eq-(2) in eq-(1) we have  $\Delta f = \frac{2Vr}{c/f}$
- In case of CW radar two separate antennas are preferred for transmission & reception in order to get the isolation between the transmission reception channels.
- If a single antenna is used it may, reduced the sensitivity of the receiver.

Advantages:-

- It gives an accurate measurement of relative target speed using low transmitter power (nearly = 100w)
- Simple circuitry.
- Low power consumption.
- Small equipment size.

Disadvantage:-

- Small maximum power transmission limits range of operation.
- Uncertain output in case of multi target scenario.
- In does not have capability of range calculation.

Applications:-

- (1) Speed measurement of Automobile, Guided missiles etc.
- (2) It can detect presence of moving objects in stationary background which make suitable to be employed for security purposes during the night & bad weather.
- (3) Detection of moving aircraft in ECM (Electronic counter measure) systems.

### Moving Target Indicator (MTI) RADAR:-

- The moving target in dictator radar system is designed on Doppler Effect in which the phase correlation of the transmitted pulse and the received pulse is processed in order to track the moving targets.
- The phase of the received signal is compared with the transmitted signal to get the target parameters.
- In case of moving target the phase of the received signal continuously varies where as in case of steady target the phase remains unchanged. By comparing the phase of received signal, the steady target signals are eliminated from the display unit.

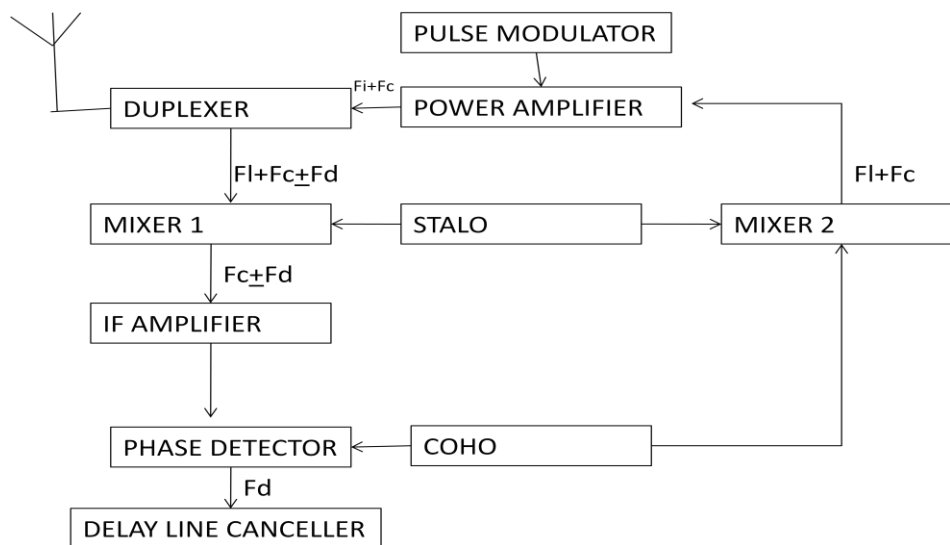

- The fig, shows the block level concept of a MTI system. The receiver channel is identical to a standard radar system except the local oscillator which is having a very high frequency stability & a limiter is included in the IF amplifier so that the echo signal applied to the phase detector which always have same amplitude.
- The oscillator providing the different phase is termed as coherent oscillator (COHO) operating at a frequency i.e closely the difference between the transmitter & the stable oscillator (STALO) frequency.
- When the magnetron in the transmitter section transmits the pulses whose phases are same, the received pulses phase is dependent on the target movement.
- It is necessary that the phase of coherent oscillator must be matched with the phase of transmitter for each transmitted pulse.
- This is achieved by rejecting power from each transmitted pulse into the COHO channel by the coupler.
- The phase detector o/p for successive pulses is subtracted from each other by a delay line.



- The delay offered by the delay line is exactly equals to one pulse repetition time period of the signal transmission.
- So the o/p of the delay line deliver echo of the same target corresponding to the phase detector output produced by the next transmitted pulse.
- The delayed & un-delayed echoes are then subtracted by the subtractor. Here the phase comparison is carried out at the intermediate frequency.

### **Radar Indicator**

- The output of the radar receiver is always displayed to the radar operator with the help of cathode ray tubes.
- The displays are either intensity modulated or deflection modulated depending on whether the trace is deflected or brightened by the presence of echo.
- There are different types of indicator used in the radar system to display the target are mainly.
  - (i) Plan position Indicator (PPI)
  - (ii) A – scope Indicator.
  - (iii) B – scope Indicator.

#### (1) Plan position Indicator PPI



- PPI is a intensity modulated display system representing the approximate target range and relative Bearing with respect to the central axis of the radar antenna.
- The saw tooth timing wave deflects to the cathode range pulse radials outwards from the center & synchronized with the transmitted pulse. The distance outward from the center is proportional to the distance of the target from the radar.
- The angular direction in which the saw tooth timing wave deflects the cathode ray spot at any instant is made to correspond to the direction in which the antenna beam is directed at the movement.

- The signals from the receiver output are applied to the control electrode of the CRT.
- The signal of significant amplitude causes an intensity modulated spot on the CRT when the beam or sweep passes the target position.
- Depending on the position of the target from the centre point of the CRT, the radar operator can calculate the approximate range of the target by the range rings.
- The Bearing information of the target can be determined by checking the target position w.r. to the bearing ring which is placed around the PPI.
- Long persistence time phosphors are normally used to ensure that the face of the PPI screen doesn't flicker.
- The resolution on the screen depends on the bandwidth of the antenna, pulse length & the transmitted frequency etc.

(2) A-SCOPE:-

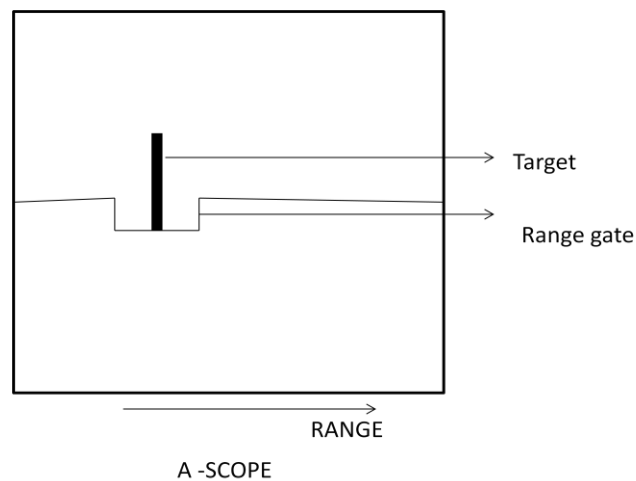

- A-scope is a rectangular indicator which is deflection modulated.
- A linear saw tooth voltage is applied to the horizontal deflecting plates which move the sweep from left to right.
- The fly back period is very small.
- In the absence of the target a simple horizontal line is displayed on the screen.
- When the target signal is present at output of the receiver section it is applied to the vertical deflecting plates which makes a vertical impression on the horizontal line showing the target position.
- The range of the A-scope can be calibrated by adjusting the saw tooth wave duration.
- In case the A-scope to be used for the whole radar range, the duration of the saw tooth wave must be equal to the pulse repetition time period of the transmitter & the target range is the displacement measured from the left hand side of the screen.

(3) B – SCOPE:

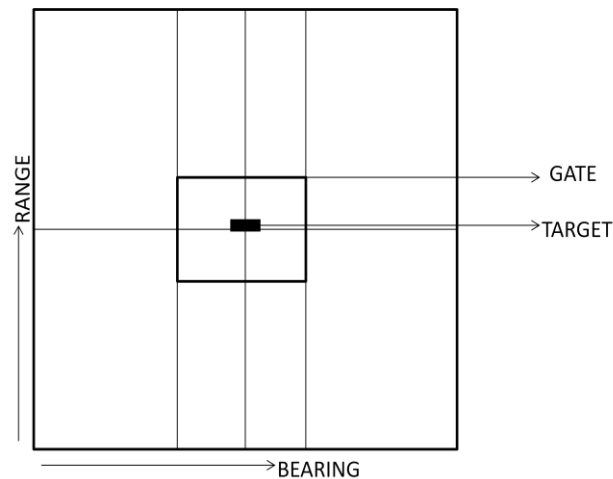

B-SCOPE

- The above figure shows the screen representation of the B – Scope.
- B – Scope is having a rectangular display which is intensity modulated .
- In this case one axis represents the range coordinate & the second/other represent the angular coordinates. So these indicators may be use for accurate acquisition of target in bearing & elevation.
- This angular coordinate system is limited to the beam width of the transmitting antenna.

**Aircraft Landing System (ALS)**

- During the poor visibility condition, It is not possible by the pilot to land the aircraft without any help of radio aids.
- There are two possible ways to help the pilot for proper landing of the aircraft.
  - (i) Instrument Landing System.
  - (ii) Ground Control approach.

i) INSTRUMENT Landing System:-

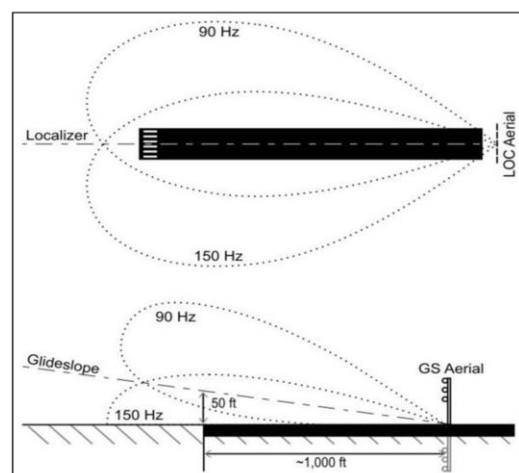
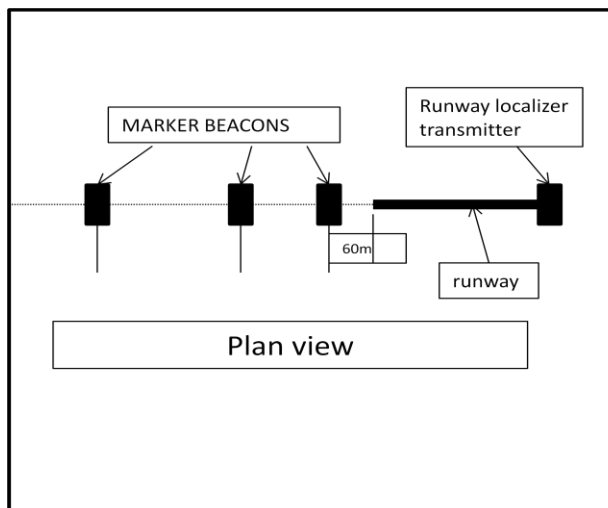

- The figure shows the arrangement of radar beacons on the approach path to the runway which guides the pilot for easy and accurate landing point estimation of the aircraft.
- Out of all these beacons the glide path equipment and runway localizer transmitter are horizontally polarized and the marker beacons are vertically polarized.
- The runway localizer enables the airplane to approach the runway from proper direction.
- It consists of two horizontally polarized very high frequency radar which are omni-directional in nature.
- The radiated wave is a single carrier wave associated with both the antennas is amplitude modulated.
- When both the transmitters transmit simultaneously, they produce a null signal path along the runway, which is sense by the receiver at the aircraft through the indication system & the pilot align the aircraft to the null direction.
- Once the aircraft achieves the proper landing direction the descending procedure starts.
- The height of the aircraft from ground level is adjusted by the pilot by sensing the beams of marker beacons.
- The marker beacons are vertically polarized antenna with a fixed distance from the runway as shown in the figure.
- The different marker beacons are identified by distinct tone modulation and in general the 7km beacons generates 400 cycles of dashes & 1.5 km beacon produces 1300 cycle dots and the 60m beacon produces 3000 cycles un-modulated signal.

Main precaution:-

- The localizer and Glide path antenna system should be completely freeform spurious equi-signal path, which may result from interaction of side lobes.

ii) Ground control approach:-

- This system employs two radars, one for long range target identification & 2<sup>nd</sup> for controlled approach of the aircraft towards the runway.
- The long range radar is having a range of about 50 kms.
- The 2<sup>nd</sup> radars has two displays, the 1<sup>st</sup> display represents the target elevation in 'y' co-ordinate target range in X- coordinate while the 2<sup>nd</sup> display represents the bearing & range of the target on a PPI.
- An approximate glide path is indicated on the 1<sup>st</sup> display & the direction of approach to the glide path is control by the 2<sup>nd</sup> display.
- The aircraft to be landed is 1<sup>st</sup> taken to the proper direction of approach with the help of 1<sup>st</sup> long range radar.

- A controller/operator at the indicator of the 2<sup>nd</sup> radar then takes over the aircraft for landing by establishing a voice link between the aircraft pilot & the control station depending on the distance from the runway and height of the aircraft from ground level, the controller guides the pilot for descending towards the runway.
- If the range & height of the aircraft are not in proportion the aircraft pilot is instructed to move upward & reproach the glide path again

Advantages:-

- (i) In the aircraft no equipment is required other than the radio receiver for landing system.
- (ii) The ground installation can be mobile.

Disadvantages:-

- (i) Due to a number of human links in the process, the responsibility of the pilot for making a successful landing is taken away from him.

### **RADAR Aids to Navigation**

- The position of air craft or a ship can be found by use of radio navigation aids. This is achieved by installation of radio transmitter and receiver at known location on the earth surface as well as at air craft or ship which works in conjunction with those on earth.
- The rectilinear propagation and constant velocity of electromagnetic waves held this system to provide navigation parameter like distance, direction, etc. by direct and indirect measurement of delay occurring between transmission and reception of these waves.
- The measurement of direction, distance and the difference between two transmitters give an indication of the position of an air craft or ship leading to correct navigation.
- Direction finding through radio is one of the very earliest methods of electronic navigational aids widely used in ship and air craft even today.

### **NAV SAT (Navigation Satellite System)**

- It is used for giving self position of Naval ships with the help of satellite system.
- The satellites are placed at low earth orbits at an altitude of about 1100 km with an orbital period of 106 minutes.
- There are 5 satellites used to provide global coverage.
- Another 5 satellites are placed in the same orbit for redundancy.
- The orbits of the satellite were chosen to cover the entire earth surface & which are crossed over at poles and spread out at the equator.

- The system provides an accuracy of roughly 200 mtrs and also the timing synchronization about 50  $\mu$  sec.

Operation:-

- The system satellite broadcast the UHF carriers, the satellite position & clock correction are uploaded twice every day to each satellite from the base stations.
- This broadcast information allows a ground receiver to calculate the location of the satellite at certain point of time.
- Use of two carriers permits the ground receiver to reduce navigation error caused by ionosphere.
- The satellite Broadcast on 150 MHz & 400 MHz frequency bands.
- The multiple frequencies are used to compensate the bending of the satellite radio beams by the ionosphere and cancelled out, thereby increasing the location accuracy.
- The critical information that allowed the receiver to compute location was a unique frequency curve caused by the Doppler Effect.
- The Doppler Effect causes an apparent compression of the carrier wave as the satellite approaches the receiver and stretching the wavelength as the satellite recedes /goes away from the target.
- The received carrier variation can be much as 10 KHz for a satellite speed of 17000 miles/hour.
- This Doppler curve is unique for each location, within the line of sight of the satellite.  
Ex- The earth rotation caused by the ground receiver to move towards or away from the satellite orbit, creating a nonsymmetrical Doppler shift approach & allowing the receiver to determine whether it was east or west of the satellite's north, south, ground track.
- The navigation software used the satellite motion to compute a trial Doppler curve based on the initial location of the receiver.
- The software then perform a least square curve fit for each 2 min section of Doppler curve & moving the trial position until the trial Doppler curve must closely matched with the actual doper received from the satellite for all two minute curve segment.
- The positional accuracy up to 100 meter can be achieved from slow moving ship through the system.

## SATELLITE COMMUNICATION

Satellite is an electronic repeater placed above the ground to enhance the data common.

➤ Depending on the shape of the orbit, the satellite orbit can be broadly classified into two categories.

(i) Circular orbit satellite.

(ii) Elliptical orbit satellite.

➤ Depending on the placing of the orbits with respect to the latitude of the earth, the satellite can be classified into the following three categories.

(i) Equatorial satellite.

(ii) Polar satellite.

(iii) Inclined satellite.

➤ Depending on the height of the satellite above the ground level the orbit of the satellite divided into 3 categories.

(i) Low earth orbit satellite.

(ii) Medium earth orbit satellite.

(iii) Geo stationary orbit satellite.

(i) Low earth orbit (LEO) satellite:-

The LEO satellites typically at a light 760 km to 1800 km (less than 2000km) have been launched to provide mobile common link.

➤ They follow an elliptical path.

Example of - LEO satellite is iridium satellite system.

➤ This system covers the whole world with 72 [66+6 stand by] polar orbiting satellites.

➤ It provides up to 10 spot beams (the foot print of the satellite is divided into spot beams, which facilities the reuse of frequency)

➤ The orbital period for this satellite system is about 100 minutes.

➤ The modulation pattern used is QPSK (Quadrature phase shift keying)

➤ The frequency for data common used is given below.

23 GHz for satellite to satellite link.

29 GHz for uplink.

19 GHz for downlink.

➤ The satellite system can handle voice, data, fax etc.

(ii) MEO (Medium Earth orbit Satellite)

- The MEO satellite system generally orbits at an altitude of 10,000 km, Generally used for commercial satellite telephone service.
- It offers a signal propagation delay of about 70 msec.
- It also provides up to 60 spot beams. An example of MEO satellite system is Glob star which comprises of 48 satellites (44+4stand by) aimed at polar regions of earth.
- The orbital plains are inclined at 50° to equator & concentrate on 70° north & south latitudes.

(iii) GEO:- (Geo stationary orbit satellite)

- The GEO satellite orbit around the earth at an altitude of about 36000km.
- They orbit around the equator line & having circular shape.
- There are three satellites required for total global coverage.
- The signal propagation delay offered by this satellite system is about 250m sec.
- It provides up to 150 spot beams.
- Few examples of Geo satellites are Asia cellular system, Khuraya etc.
- Asian cellular system satellites provide coverage from India to Indonesia & Australia.
- The Khuraya system connects 50 countries from west Asia to India Sub continents positions at 44° east longitude on Indian Ocean.
- The Geo stationary satellites are synchronous to the earth rotation. The orbital velocity of the satellite is equal to the velocity of a point on earth equator.
- Let M & m be the mass of earth and satellite respectively.
- Let R & R<sub>E</sub> be the radius of satellite orbit and earth respectively.
- If W be the angular velocity of the satellite in radians/ second, then the centrifugal force acting on the satellite is given by

$$F_{cf} = mRW^2 \text{ -----(i)}$$

- The centripetal force equal to the gravitational force acting the satellite given by Newton's gravitational law.

$$F_{cp} = \frac{GMm}{R^2} \text{ -----(ii)}$$

- Where, G is the gravitational constant = 6.672 x 10<sup>-11</sup> m<sup>3</sup>/kg/sec<sup>2</sup>

$$M = \text{mass of the earth} = 5974 \times 10^{24} \text{kg}$$

$$R_E = 6370 \text{ km}$$

- At the earth surface, the gravitational force is given by

$$f_g = mg \text{ -----(iii)}$$

$$\text{Where, } g = \text{Acceleration due to gravity} = 9.8 \text{ m/s}^2$$



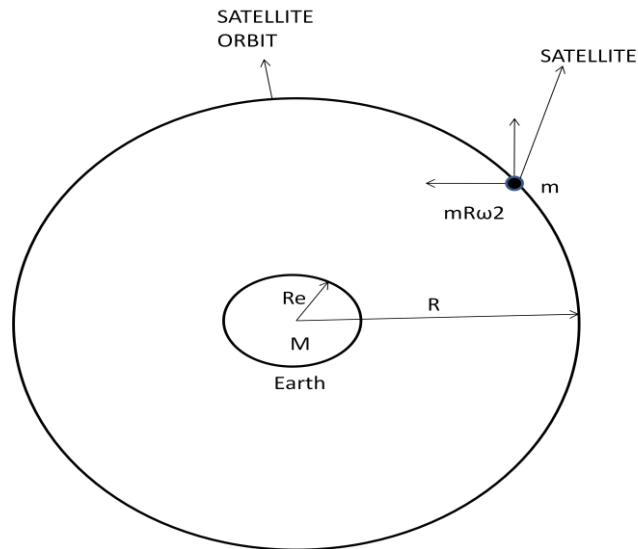

➤ Hence  $\frac{GMm}{R_E^2} = mg$  -----(iv)

Comparing eq<sup>n</sup> (1) & eq<sup>n</sup> (4) we have

$$mR\omega^2 = \frac{GMm}{R^2} = mg \frac{R_E^2}{R^2}$$

f = Rotation rate of the satellite in revolution/day.

Value f=1

Hence e,  $R = (g \cdot R_E^2 / \omega^2)^{1/3} = 42,208 \text{ km}$

➤ Hence the height of the satellite from the earth surface is given by  $R - R_E = 42208 - 6370 = 358.38 = 36000$

➤ From Kepler's law for circular orbit the time period of rotation is given by

$$T = 2\pi (R^3/GM)^{1/2}$$

➤ Putting the values we have

$T = 2.3 \text{ hour } 56 \text{ minute } 4 \text{ sec} = 24 \text{ hour.}$

➤ The satellite velocity for circular orbit is given by

$$V = (GM/R)^{1/2}$$

➤ The signal transmitted to the satellite is returned back to the receiver after travelling a distance.

$$d = 2(R - R_E)$$

➤ The EM wave travels at speed of light i.e  $3 \times 10^8 \text{ m/sec.}$

➤ The time delay for the signal reception given by

$$T_d = C/D = 250 \text{ msec}$$

## Kepler's Laws for Orbits

- So far, we have assumed that satellites travel in circular orbits, but this is not necessarily true in practice. Newton's Laws can be used to derive the exact form of a satellite's orbit.
- However, a simpler approach is to look at Kepler's Laws, which summarize the results of the full derivation. Kepler's Laws (1609 for 1,2; 1619 for 3) were based on observations of the motions of planets.
  - (1) All planets travel in elliptical orbits with the Sun at one focus (defines the shape of orbits).
  - (2) The radius from the Sun to the planet sweeps out equal areas in equal times (determines how orbital position varies in time).
  - (3) The square of the period of a planet's revolution is proportional to the cube of its semi major axis (suggests that there is some systematic factor at work).

### Satellite Frequency Bands:-

|    | <u>Band</u>          | <u>uplink freq Band (MHz)</u> | <u>Down link freq Band(MHz)</u> |
|----|----------------------|-------------------------------|---------------------------------|
| 1. | UHF Military         | 292-312 MHz <sub>2</sub>      | 250 – 270 MHz <sub>2</sub>      |
| 2. | C – Band Commercial  | 5925 MHz <sub>2</sub> – 6425  | 3700 – 4200                     |
| 3. | X – Band Military    | 7900 – 8400                   | 7250 – 7750                     |
| 4. | Ku – Band Commercial | 14, 000 – 14, 500             | 11700 – 12200                   |
| 5. | Ka – Band Commercial | 27, 500 – 30, 000             | 17, 700 – 21, 200               |
| 6. | Ka – Band Military   | 43, 500 – 45, 500             | 20, 200 – 21, 200               |

In addition to all these bands, for metrological satellites the following bands are used

- (i) 16.68.4 to 16.70 MHz<sub>2</sub>.
  - (ii) 1670 to 1690 MHz<sub>2</sub>.
  - (iii) 1690 to 1700 MHz<sub>2</sub>.
  - (iv) 1700 to 1710 MHz<sub>2</sub>.
  - (v) 7450 to 7550 MHz<sub>2</sub>.
- The uplink & down link frequencies used in the satellite system are made different in order to avoid interference between the uplink & down link signal.
  - The downlink signal frequency is made lesser than the uplink frequency in order to avoid bulky circuits, high power requirement, and high maintenance requirement at the satellite station in order to reduce the cost with high reliability of satellite operation.

## General Structure of Satellite Link System

- The satellite communication system consists of a satellite in space that links many earth/base stations on the ground.

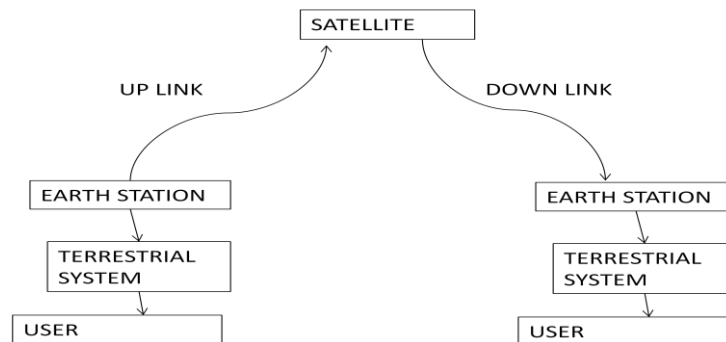

- The user is connected to the base stations through terrestrial network which may be telephone switch or dedicated link to the base station.
- The user generates the base band low freq signal that is processed & transmitted to the satellite at the base station. The block level representation of earth station functionality is shown in the fig below.

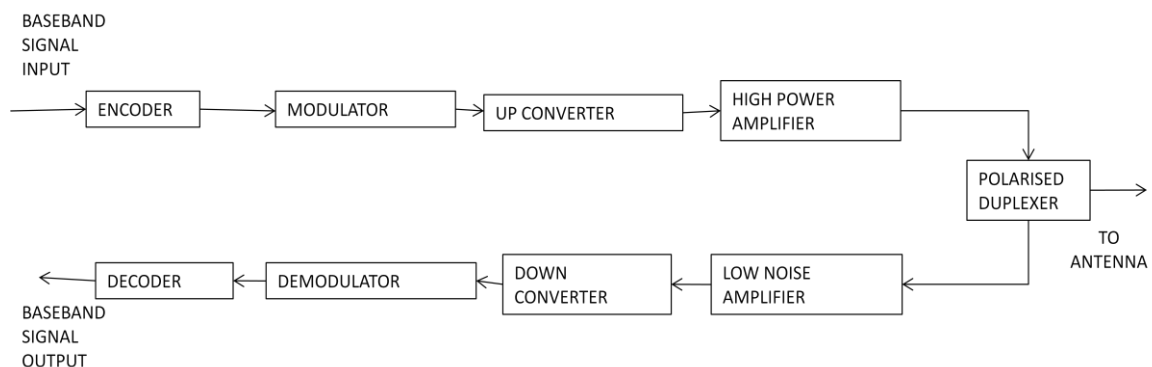

Block diagram of earth station

## Satellite Earth Station

- It is broadly a combination of a transmitter section & receiver section coupled to a common antenna through duplexer.
- The terrestrial networks which multiplex the base band signal received from the user & does the necessary formatting. Then it is fed to the transmitter section.
- The earth station or base station first encodes the signal followed by modulation. This modulated encrypted signal is frequency translated to the uplink frequency band by the up converter.
- Then the signal is amplified by the high power amplifier & directed to the appropriate polarization port of the antenna feed.
- The satellite antenna receives the uplink signal & buffers before any process.

- Then signal is decoded in the transponder & checked for the recipient address & re-again encodes the signal.
- Then the transponder translates the signal frequency to downlink frequency & pass it through a power amplifier before feeding the downlink antenna at the satellite station.
- The signal received from the satellite is amplified by a low noise amplifier at the frontend at the receiver.
- Then the signal is down converted (frequency) from the down link frequency at the base station.
- Further the signal is demodulated & decoded to derive the original base band signal.
- Critical components must be installed with redundancy with automatic switch over in the event of failure. So that uninterrupted operation is maintained at the satellite.
- There may be interference caused by side lobes of adjacent satellites. Other sources of interference include ground microwave relay links, sun transit effect & inter modulated products generated in the transponder & on earth station.

### Satellite Transponder

- The transponders are the repeaters at the satellite which performs the basic two functions.
  1. The amplification of the signal from on I/P power of the range (- 100db) in watt to an output power of 10db(w) so about 110db gain is provided by the transponder.
  2. The frequency down conversion that avoids the interference between high amplitude transmitted signal and the weak incoming signal.

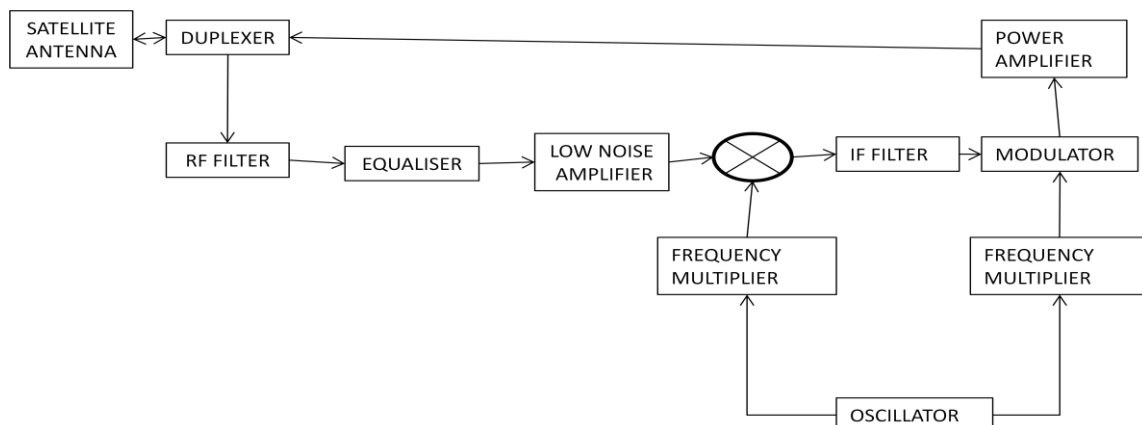

- The transponders having additional provision of detection & demodulation process are known as regenerative transponders.
- The satellite antenna receives the uplink signal & passes it to the front end of the transponder through the diplexer.

- The diplexer isolates the transmission & receiver signal in order to utilizing a signal antenna for both transmission & reception purpose.
- The front end of the transponder comprises of RF filter, equalizer & low noise amplifier stage.
- The RF filter are generally band pass/low pass waveguide II wave filter used for achieving desired masking, noise rejection& equalization they also contribute towards the ckt noise.
- The equalizer is used to cancel out the delay produced by the RF filter.
- The low noise amplifiers are having very high gain. Generally tunnel diodes are used at this stage for low frequency band (“C” band) & FETs are used for high frequency band (‘K’ band).
- The transponder shown in the figure above is a regenerative transponder. The frequency translation is carried out by first translating the uplink frequency to a low intermediate frequency band & then the entire IF band is modulated to the down link RF band.
- These allow for the uplink commands transmitted with the carrier modulation to be recovered during the demodulation & satellite telemetric to be inserted into the base band for down link modulation.
- After frequency translation the power amplifier usually consist of TWTs commonly used as high gain broad band amplifier. It provides a max<sup>m</sup> gain of about 55db. Then the signal is passed to the antenna through the diplexer unit for retransmission.

### Direct Broadcast System (DBS)

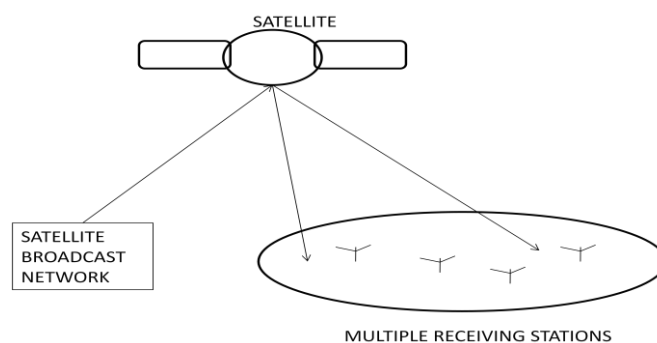

- The direct broadcast system is based on one point to multipoint connectivity feature of the satellite communication system.
- The above figure shows the broad mechanism of a DBS.
- The system takes full advantage of inside area coverage of satellite foot print.

- The satellite broadcasting consists of one transmitting system/Base station & many receive only stations as show in figure.
- The program is to telecast is beamed of to the satellite via uplink antenna from the studio having base station antenna system.
- In case of earth station or base station & uplink antenna is remotely located, the program to be telecast is 1stly collected by a mobile base station & transmitted to the nearly base station through the satellite link or terrestrial link.
- Then the base station activates the normal broad cast station.
- The downlink signal is received at each receiving station & distributed among the users by terrestrial link.
- In case of wide area broad casting, multiple satellites can be utilized linking different base station through the signal hopping process.

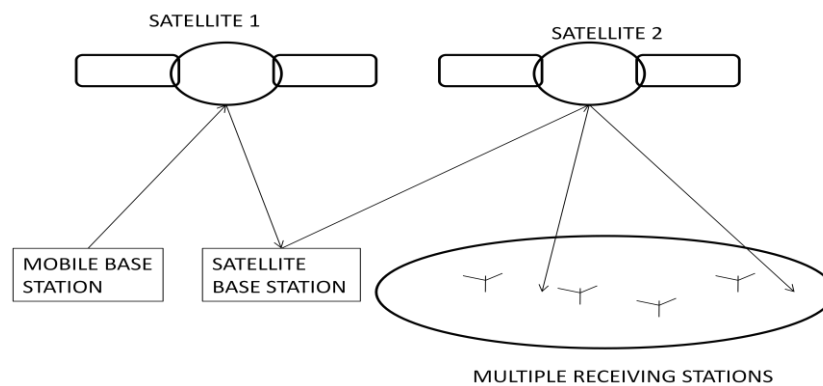

### **Global Positioning System (GPS):-**

- The GPS systems are used as means of navigation for ships & aircrafts and also for surveying and many other applications.
- The main features of GPS are.
  - (1) It consist of 24 satellites at MEO orbit at an altitude of 20,200km with  $55^{\circ}$  orbital inclination providing navigation & timing information.
  - (2) The satellites are grouped into four called constellation, each separated by  $60^{\circ}$  longitudes.
  - (3) The orbital period of each satellite is 11 hours and 58 minutes. At any instant at least 4 satellites are visible from any base station.
- The GPS provides the following information
  - (i) Extremely accurate three dimensional position information.
  - (ii) Extremely accurate velocity information
  - (iii) Precise timing service.

(iv) Continuous real time information

- The world wide GPS satellite control system consists of 5 monitoring stations & four ground antennas.
- The monitoring stations use GPS receiver to passively track the navigational signals of all the satellites.
- Information from the monitoring system is then processed at the master control system which sends updated navigation information to GPS satellites through ground antennas operating in 's' band.
- The GPS satellites broadcast signals on two different frequencies which can correct for distortion effect due to ionosphere.
- The signal takes 35 to 65 sec to reach from satellite to earth station.
- Horizontal position accuracy can be achieved up to 7 to 10 meter.
- The stability of the clocks on board is approximately 1sec/30,000yrs.

GPS TRANSMITTER

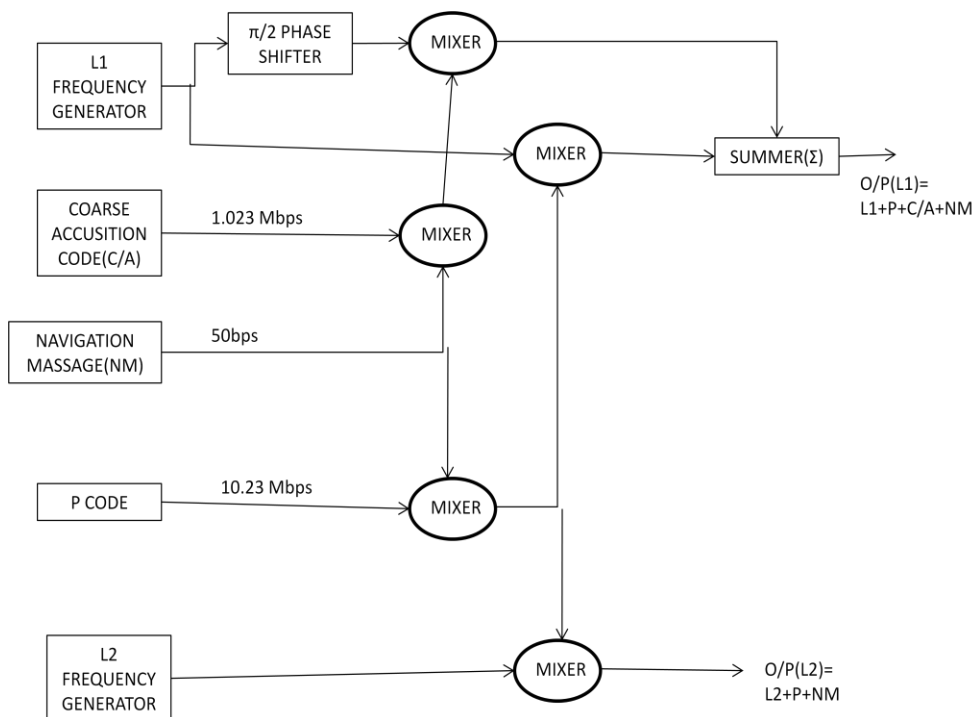

- The transmission by GPS satellite is based on the pseudo random sequence codes.
- The Generation of  $L_1$  &  $L_2$  signals is shown in the figure above.
- All the satellites in the GPS system transmits the coarse accusation (C/A)code & at frequency 1575.42 MHz using BPSK modulation technique.
- It is 154 times more than the master clock frequency (10.23 MHz).

- The pseudo random sequence code lasts exactly 1msec as 1023 bit sequence are transmitted at 1.023 MHz frequency.
- The transmission of positional code uses BPSK modulation technique at  $L_2$  carrier frequency (1127.6 MHz at 4 carriers in phase quadrature with coarse accusation code).
- The coarse accusation code & positional code transmission from all GPS satellites are overlaid in  $L_1$  &  $L_2$  frequency bands, marking the GPS system (DSSS) direct sequence spread spectrum system.
- At the receiver the signals from individual GPS satellites are separated using knowledge of the unique coarse accusation code that is allocated to each satellite.

#### GPS RECEIVER:-

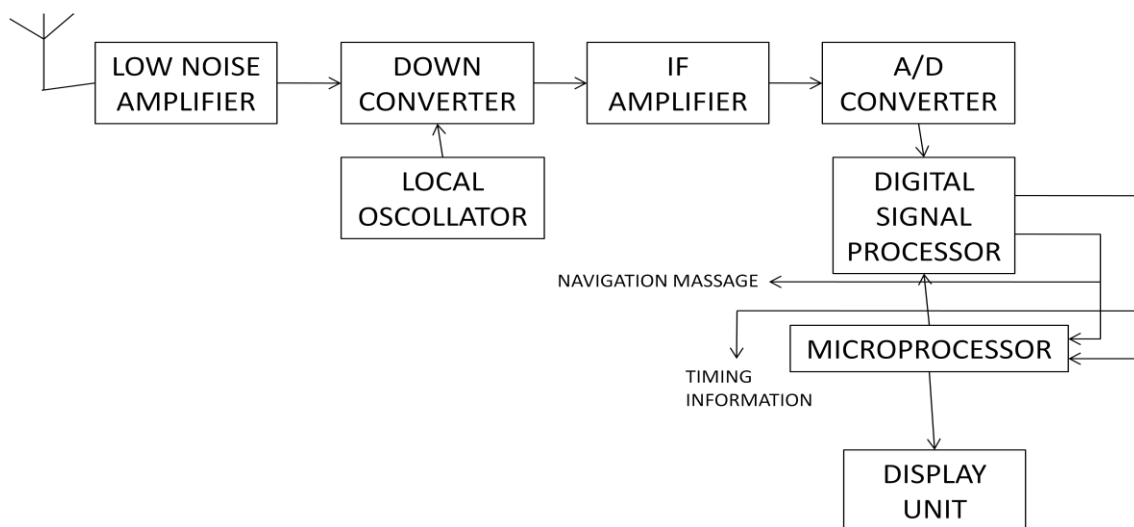

- The fig shows the schematic of a coarse accusation code GPS receiver.
- The antenna is circularly polarized which receive the downlink signal from the satellites.
- The low noise amplifier selects the desired frequency band and amplifies the signal.
- The super heterodyne receiver consisting of frequency down converter & local oscillator generates an intermediate frequency signal of a band with about 2 MHz.
- This analog signal is digitized by the A/D to converter which consists of a sampler & quantizer.
- The digital signal processing unit processes the digital portion of received signal, which consist of a coarse accusation code generator and a correlator which select the code sequence.
- The microprocessor carries out the timing measurement & calculates the receiver position.
- The output data is displayed on the display device.



## Very small aperture Terminal (VSAT)

The main characteristics of a VSAT system are.

- They operate in the 'Ku' band with earth/base station with antenna diameter of 1 to 2 meter & transmitter power 1 to 2 Watt.
- The earth stations are usually organized by star network topology in which the earth station connect to a central hub station through GEO satellites.
- Data rate on this link is from a few 1000 bits/sec to 256 kbps depending on the traffic requirement.
- The VSAT systems are used to link business and stores to a central computer system so that the sale traction can be completed more rapidly than by using telephone & modem. Hence the central offices can rapidly redistribute and collect information from a large no of location is a region or country.

OPERATION:

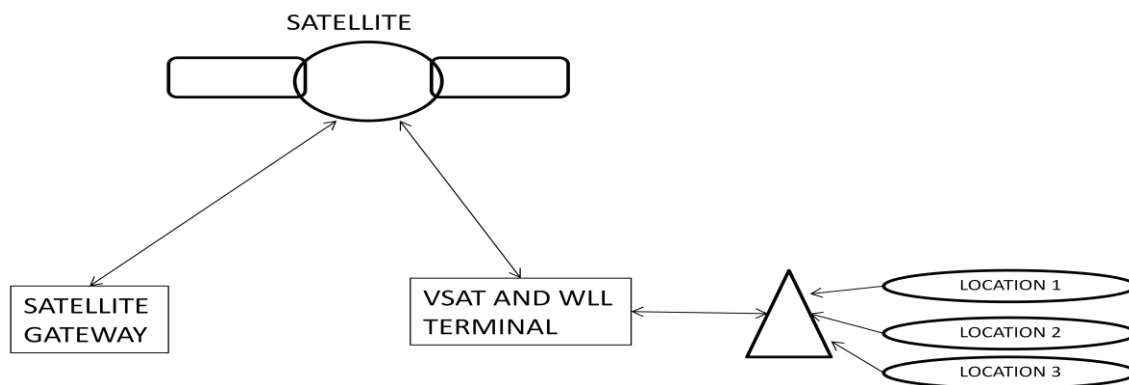

- The wireless local loop is coupled with VSAT distribution architecture as shown in the figure above.
- The Geo stationary satellite links a large no of VSATS with the main switching centre in a large city.
- It VSAT acts as a link to the local switching centre in the village or rural community with the final mile of telephone link being carried over with wireless local loop.
- The characteristic of a VSAT network are
  - (i) It allows multimedia traffic to be broadcast directly to the end user but generally handles only small traffic.
  - (ii) The user accesses the satellite in a demand assign multiple access (DAMA) mode. Wherever the data is send or received, a short message above the transaction is replied in due course. For ex :- the credit card transaction

(iii)The communication between satellite and earth station is completely automatic and transparent to the user.

(iv)Due to the very less traffic, dedicated satellites are not used for this purpose instead leased or fractional leased transponder is used for medium to small network.

### Multiple Access :-

- The ability of satellites to carry many signals from multiple locations at the same time is known as multiple access.
- It allows the multiple earth stations to communicate simultaneously to a single satellite so that bandwidth of the satellite can be effectively used.
- The basic form of multiple access employed by all communication satellite is the use of multiple transponders.
- Though frequency reuse with multiple antenna beams & orthogonal polarization the spectrum can be reused several times.
- The frequency spectrum of the satellite is divided into smaller band widths which are allocated to the different transponders.
- This allows separate communication links to be established through the satellite on the basis of transmitter frequency.
- Depending on the method of allocation of the spectrum, access techniques are
  - (1) FDMA (Frequency division multiple access)
  - (2) TDMA (Time division multiple access )
  - (3) CDMA (Code division multiple access)
  - (4) DAMA (Demand assign multiple access)

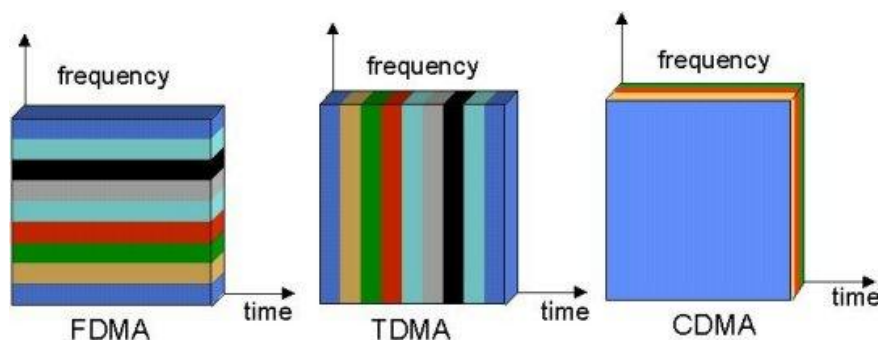

### FDMA:-

- It is the first multiple access technique used in satellite communication system.
- In this system, individual telephone channels can be shifted in frequency from baseband to a higher frequency so that they can be stacked into a group of channels using frequency division multiplexing as shown as figure above.

- In this system all users use the satellite at the same time but with a unique allotted frequency band. It can be used both with analog & digital signals.

#### TDMA:-

- In this system a no. of earth station take their turn for transmitting burst of RF signal to a transponder.
- All the TDMA system are digital. This system allows a single transponder to be shared in time domain between RF carriers from different earth stations.
- Here the RF carrier from each earth station sharing a single transponder is sent as a burst at a specific allotted time.
- At the satellite, burst from different earth station arrived sequentially. So the transponder carries a near continuous signal sequence of short burst coming from different earth stations.
- The burst transmission is assembled at a transmitting earth station so that it will correctly fit with TDMA frame at satellite station.
- The frame as a length varying from 125  $\mu$ sec to many milliseconds and the burst from the earth station must be transmitted at the correct time to arrive at the satellite at correct position within the TDMA frame.
- This requires synchronization of all earth stations in a TDMA network adding considerable complexity to the equipment at the transmitting station.
- The transmission time is to be closely monitored to avoid any data overlapping.
- A time overlap of two RF signals is called collision & results is loss of data of both carriers.
- High speed TDMA systems operate at a speed of 120 MBPS.

#### Advantages:-

- (1) The data can be easily reconfigured for changing traffic demands due to the use of digital modulation techniques.
- (2) Less noise interference.
- (3) It can easily handle mixed voice, video & data traffic.
- (4) Non linearity effect of the transponder can be overcome as one signal takes the whole band width of the transponder.

#### Disadvantages:-

- 1) All the earth stations need to transmit at high bit rate to occupy the whole bandwidth.
- 2) Due to high bit rate, high transmitter o/p power is required.

- 3) Not well suited for narrow band signals from earth station.
- 4) Due to digital data, non-linearity characteristic of transponder may cause inter symbol interference. Hence equalizers are required at earth station to minimize this effect.

CDMA:-

- In this system, a no. of users can occupy all of the transponder bandwidth at all time.
- CDMA signals are encoded such that information from individual transponder can be recovered by a receiving station that is having the code used at the transmitting end.
- So there is a very less interference between the encoded signals in the same band width in the CDMA system.
- This provides a decentralized satellite network, as only the pair of earth stations that are communicating with each other need to coordinate their transition.
- Each receiving station is allocated a unique CDMA code.
- Any transmitting station that wants to send data to the desired earth station must use the correct code.
- These codes having length from few bits to many 1000 of bits are known as chips. To distinguish them from message bits of data transmitted a special sequence is used.
- The chip rate is always higher than the data rate which increases the speed of the digital transmission of the chip sequence.
- CDMA is also known as spread spectrum.
- Direct sequence spread spectrum ( DSSS) is the only type of currently used technique in satellite communication.

Advantage:-

- Here the energy of the data is spread across a wide band width which makes the signal strength less than that of noise. Hence it can't be detected by any unintended receiver. Hence providing high data security, the receiver having the code of CDMA signal can only recover the data through the process of correlation.
- The base station is immune to jamming due to the use of a pseudo random noise sequence coding.
- An application like soft handoff is possible with this technology which is extensively used for mobile communication.

Disadvantage:-

It is less efficient in handling the band width of satellite as compared to TDMA & FDMA.

### **Communication Satellites:-**

- It is an artificial satellite station in space for the purpose of telecommunication.
- Modern communication satellites use LEO & GEO.
- For fixed point to point services they provide a microwave relay radio technology complementary to that of communication through cables. They are also used for mobile application such as communication to ships, vehicles, aircrafts., hand held terminals & for TV & Radio broadcast for which application of other technologies such as cable TV is impractical or impossible.
- The communication satellites are usually composed of following subsystems.
  - (i) Communication pay load, normally composed of transponders, antennas & switching system.
  - (ii) Propulsion systems used to bring the satellites to its desired orbit.
  - (iii) Station keeping tracking & stabilization subsystem used to keep the satellite in the right orbit with its antenna pointed in the right direction & its power system facing towards the sun.
  - (iv) Power subsystem use to power the satellite system normally composed of solar cells and batteries that maintain the power during solar eclipses.
  - (v) Command and control system which maintains communication with ground control stations. The ground control station monitors the satellite performance & controls their functionality during the entire life cycle of the satellite.
- Iridium system is the 1<sup>st</sup> communication satellite system launched by USA for long distance international telephone services.
- The fixed public switched telephone network (PS TN) relays telephone calls from landline telephone to the earth station, where they are transmitted to a GEO satellite.
- The down link follows an analogous as path.
- The use of fiber optic cables reduce the importance of satellite telephoning but still it is extensively used for remote unreachable islands where land line or underwater cable system does not exist.
- The satellite phones directly connect to the LEO or GEO satellite. Calls are then forwarded to a satellite teleport connected to the PSTN.
- The TV broadcasting is also now uses of the advantages of satellite communication. The direct broadcast system provides a major TV services in North America.

### **Satellite Digital Radio:-**

- The satellite radio signal that is relayed through one or more satellites and thus can be received in much wider geographical areas than FM radio station.
- Mobile services such as SARIUS, XM, and world space allow listeners to roam across the entire continent, listen to the same audio program anywhere they go. Other services such as MUZAK'S satellite deliver contained, required a fixed location receiver and dish antenna system.
- In all cases the antenna must have a clear view of the satellite i.e. line of light communication.
- In areas where tall buildings, bridges or even parking areas obscure the signal, repeaters can be placed to make the signal available to listeners.
- The satellite radio uses 2.3 GHz 'S' band in North America and generally shares the 1.4GHz 'L' band with local digital audio broadcasting stations elsewhere.
- It is a type of direct broadcast system and is strong enough that it receives the signal.
- The curvature of the earth limits the reach of the signal but due to high orbits of the satellite, 2 or 3 satellites usually sufficient to provide the radio service.
- Local repeaters similar to broadcast translator booster enable signal to be available even if the view of the satellite is blocked.
- Major tunnels can also have repeaters for continuous service.

# OPTICAL COMMUNICATION

## INTRODUCTION

- The common system utilizing the optical energy for data transfer from transmitter to receiver is known as optical communication.
- In order to carry the data through optical means, optical fiber cables are used.
- The experimental wavelengths of optical energy which are least attenuated in the channel is shown in the following graph.
- The optical window shows that the signal will be less attenuated at the wavelength 850 nm, 1300 nm, 1550 nm.
- So the optical source & the optical detector are designed for the above mentioned wavelength.

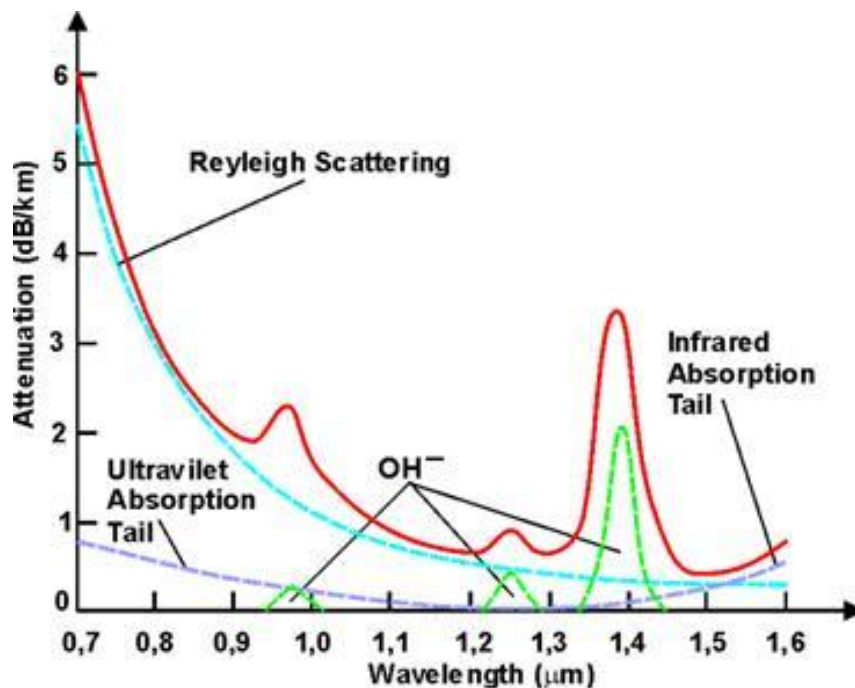

## **The advantages of optical fiber common system over the copper cable lines**

- 1) For Long distance transmission:-

Optical fibers have lower transmission losses compared to copper wires. (Attenuation/1 km channel: copper is 25db and optical fiber is 0.2 db).

Consequently data can be sent over longer distance there by reducing the number of intermediate repeaters needed to boost and restore signals in long spans. This reduction in equipment and component decreases the system cost & complexity.

2) Large information capacity:-

Optical fibers have wider bandwidth than copper wires. So that more information can be send over a single physical line, (for Example the bandwidth of co-axial line is 400 MHz where as for optical fiber it is 1 to 10GHz). This property decreases the no. of physical lines required for sending given amount of information.

3) Small size & low weight:-

The low weight small dimension of fibers offers a distinct advantages over heavy bulky wire cables in crowded underground CT ducts or in ceiling mounted cable trays. This feature is of important in aircraft, satellite & ships where small, light weight cables are advantageous & tactical military application where large amount of cables must be laid & retrieve rapidly.

4) Immunity to Electromagnetic Interfere:-

As the core of the fiber optic cable is made of dielectric material, it doesn't carry current. This makes the optical fiber immune to electromagnetic interference effect.

5) Enhance safety:-

Optical fiber offers a high degree of operational safety, since they don't have the problem of ground loops, sparks and potentially high voltages inherent in the copper wires. However precautions from laser light emission need to be observed to prevent possible eye damage.

6) Increased signal security:-

An optical fiber offers a high degree of data security. Since the optical signal is well confined within the fiber and opaque coating around the fiber absorbs any signal emission. This feature is in contrast to the copper wire where electrical signal potentially could be tapped easily. The fibers are attractive in application where information security is important such as financial, legal, government & military systems.

7) Crosstalk very little:-

Leaking of light from an optical fiber is extremely small and almost no external light enters the fiber. This leads to no crosstalk between optical fibers laid in the close vicinity or nearby.

8) Good Environmental qualities:-

Fibers are chemically inert, electrically insulators and resistant to high temperature. Therefore they can be installed in hazardous environment conditions.



## Optical Fiber Communication Spectrum:

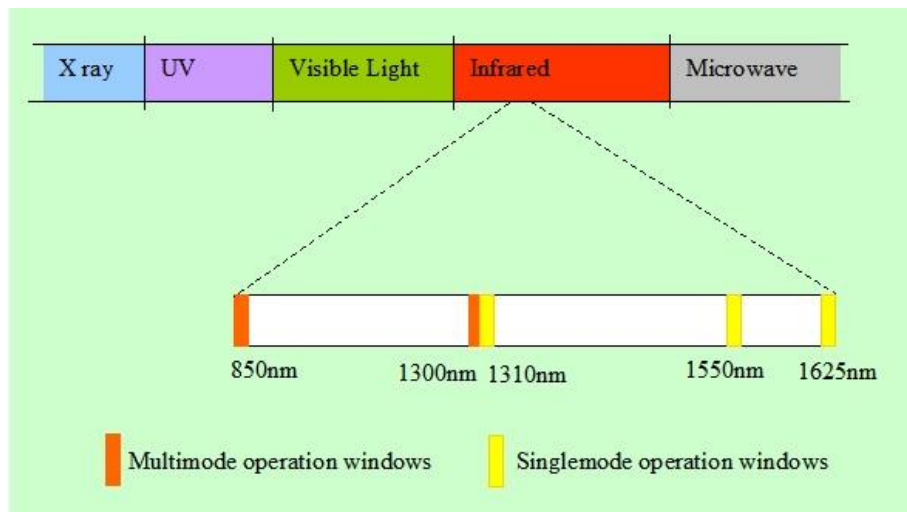

## OPTICAL FIBER COMMUNICATION LINK:-

- The key element of an optical fiber communication link can be broadly into four sections.
  - (i) Optical Transmitter Section.
  - (ii) Optical Receiver Section.
  - (iii) Optical Link.
  - (iv) Intermediate Signal Regeneration CKT/section

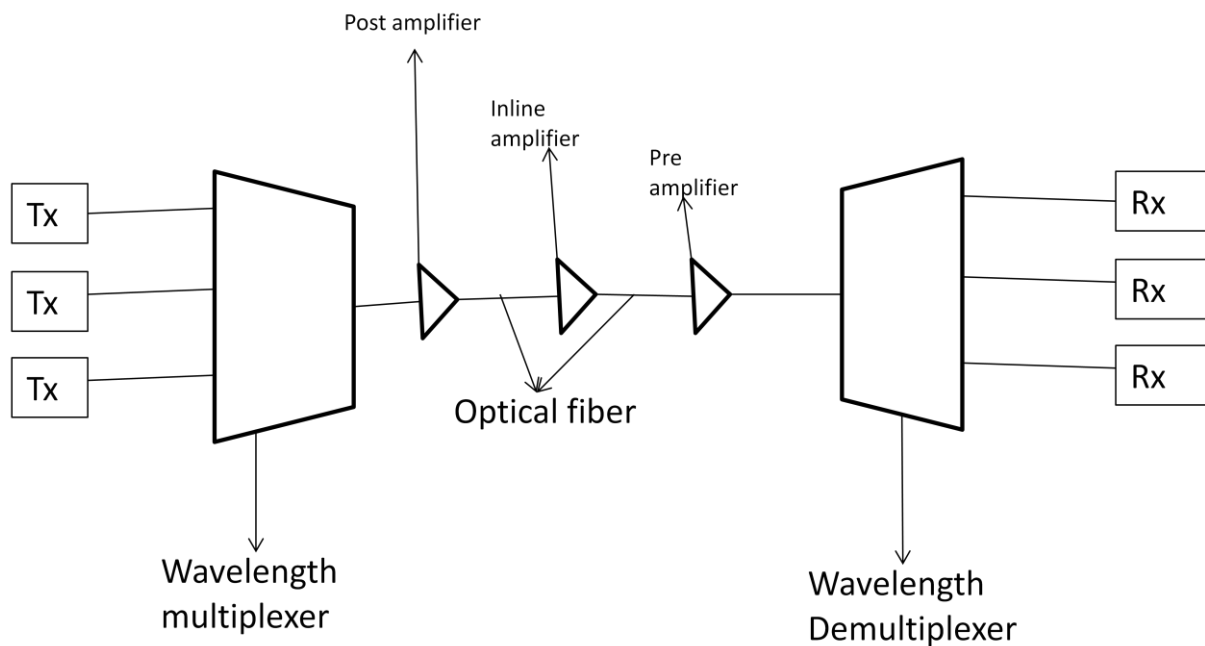

### (i) Optical Transmitter:-

- The optical transmitter converts the electrical signal into intensity modulated optical signal to be transmitted through the optical fiber.
- The sources used to convert the electrical signal to optical are laser diodes or LEDs.

(ii) Optical Receiver:-

- The optical receiver receives the optical signal from optical fiber cables & converts it to the electrical signal.
- The commonly used optical detectors are P-I-N diode & Avalanche photo diode (APD)

(iii) Optical fiber link:-

- The optical fiber link connects the transmitter and receiver and hence provides the path for data communication from transmitter to receiver.
- Depending on the length of optical fiber link, the type of optical fibers selected as follows.

| <u>Length</u>         | <u>Optical fiber type</u> |
|-----------------------|---------------------------|
| Up to 20km -----      | Multi mode step Index     |
| 20 to 100km -----     | Multi mode graded Index   |
| More than 100km ----- | Single mode step Index    |

(iv) Intermediate Regeneration Section:-

- When the optical signal passes through the optical fiber, It gets attenuated and the signal strength becomes weak.
- When the long distance link is designed, the signal loss becomes dominant. Therefore intermediate Repeater sections are used to amplify the signal so that it can be detected at the receiver side.
- These Repeaters are electrical Circuits. Therefore the optical signal is 1<sup>st</sup> converted to electrical signal and then amplified & Re-again converted back to the optical form.
- Hence the coast of these Repeaters is quite high as compared to microwave Repeaters.

**Optical Fiber Construction:-**

The optical fiber cable basically consist of 3 dusting layer namely,

- (1) Core.
- (2) Cladding.
- (3) Buffer coating.

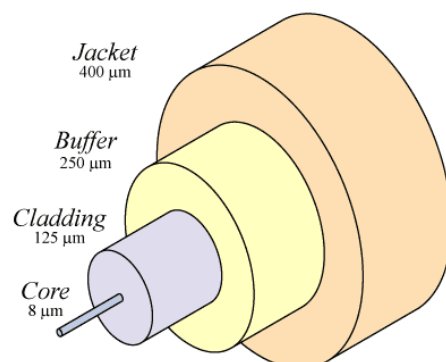

- The core is made of up silica having more refractive index than that of the cladding layer.
- The core carries the data (optical) from transmitter to the receiver.
- The core is surrounded by a solid dielectric cladding which reduces the scattering loss that results from dielectric discontinuities at the core surface and also provides mechanical strength to the fiber core.
- It also protects the core from observing surface contaminants.
- Generally the core is made of up pure silica gas ( $\text{SiO}_2$ ) and surrounded by a glass cladding.
- The buffer coatings are made up of elastic abrasion resistance plastic material.
- This material adds further strength to the fiber and mechanically isolates the fibers from small geometrical irregularities, distraction, and roughness of adjacent surfaces.
- Depending on the variation of the refractive index profile of the core, the fiber can be classified into two groups-

- (i) Step index fiber.
- (ii) Graded index fiber.

The optical fiber in which the refractive index of the core is uniform throughout and under goes an abrupt change (Step) at the core - cladding boundary is known as step index optical fiber.

- Variation in the material composition of the core the optical fibers can be classified into following 3 categories.
  - (i) Single mode step Index fiber.
  - (ii) Multi mode step Index fiber.
  - (iii) Multi mode Graded Index fiber.

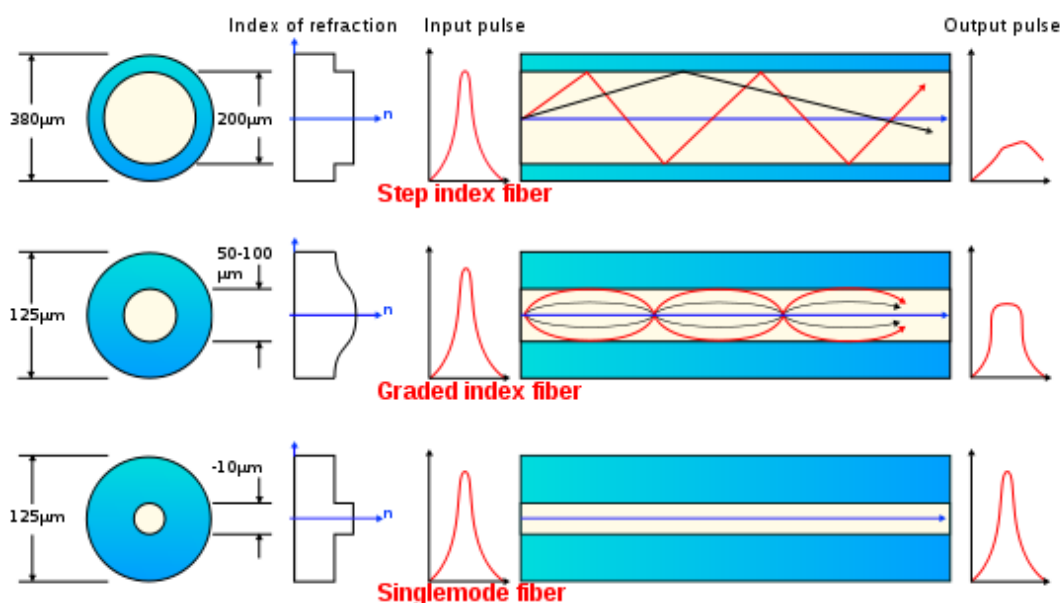

### 1) SINGLE MODE STEP INDEX FIBER:-

- Commercially available single mode fibers are step index.
- They are high quality fibers used for wide band, long distance transmission & are generally fabricated from doped silicon.
- In step Index fiber the refractive Index of the core is uniform throughout & under goes an abrupt change at the core-cladding boundary.
- The single mode step index fiber has an attenuation of 2 to 5 db per km at 850 nm operating wavelength & 0.35 db/ km at 1300 nm and 0.21 db/ km at 1550 nm.
- These fibers are ideally suitable for high bandwidth, very long distance application such as telephone common.
- These fibers need to be coupled with laser diode sources only.

### 2) MULTIMODE STEP INDEX FIBER:-

- These fibers have reasonable large core diameter & large numerical aperture to facilities efficient coupling of non-coherent light sources such as LED.
- The multi mode fibers can support upto 60,000 modes. The typical numerical aperture ranges from 0.16 to 0.5.
- It offers a attenuation 2.6 to 250 db/km at 850 nm wave length and 0.4 db/km at 1300 nm.
- It offers a band width of 6 to 50 MHz.
- It is suitable for short distance, limited band width & relatively low cost application.

### 3) MULTIMODE GRADED INDEX FIBER:-

- In multimode graded index fibers, the core refractive index is made to vary as a function of the radial distance from the centre of the core of the fiber.
- The typical value of numerical aperture is 0.2 to 0.3.
- The problem of intermodal dispersion observed in case of multi mode step index fiber can be reduced by using a graded index profile in the fiber core.
- This allows much larger band width than step index fiber.

### **Advantages of MM fibers over SM fibers:-**

- (1) The larger core diameter of MM fiber make it easier to launch optical power into the fiber and facilitate the inter connection of similar fibers.
- (2) The light can be launched into a multimode fiber using a LED source where as the single mode fiber must be excited by Laser diodes.
- (3) Although LEDs has less optical powers than laser diode, they are easier to make, Less expensive, Required Less complex driving CKT & having longer life time than laser diodes. So it makes them suitable for low cost short distance transmission system.

## MODES OF PROPAGATION:-

- In optical fiber the core – cladding boundary condition leads to a coupling between the electric & magnetic field component. This gives rise to hybrid modes. The hybrid modes are designated as HE mode and EH mode.
- The order of a mode is equal to the number E field zeros existing across the optical fiber.
- The following figure shows few lower order modes in optical fiber.

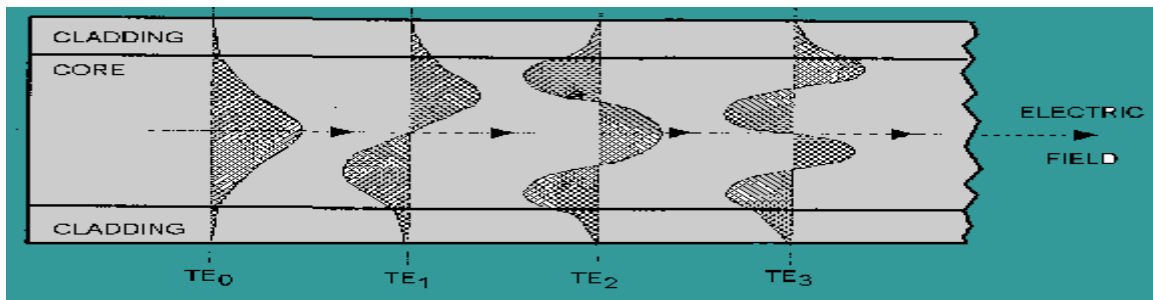

- From the above characteristic curve the following points may be noted.
  - (1) The electric fields of the guided modes are not completely confined to the core. They don't go to zero at the core cladding interface.
  - (2) The field varies harmonically in the core region of refractive index  $n_1$  and decays exponentially in the cladding region with refractive index  $n_2$ .
  - (3) For lower order modes, the fields are concentrated near the axis of the optical fiber and a very small penetration towards the cladding region is observed ( $TE_0$  mode).
  - (4) For higher order modes, the fields are distributed more towards edges of the core and penetrate further into the cladding region.
- In addition to supporting a finite no of guided modes, the optical fiber has infinite no of radiation modes. These are not confined to the core region but guided through the cladding region.
- The radiation field basically results from the optical power which is outside the fiber acceptance angle being refracted out of the core.
- Because of the finite radius of the cladding some of these radiations gets trapped in the cladding, thereby causing cladding mode to appear.
- As the core & the cladding modes propagate along the fiber, mode coupling occurs between the cladding modes & higher order core modes or guided modes.
- This coupling occurs because the electric fields of the guided core modes are not completely confined to the core but extends partially into the cladding & vice versa.
- Thus diffusion of power back & forth between the core & cladding modes occurs.
- Generally this results in the loss of power from the core mode.

- In addition to the bounded & refracted mode, another category of modes called leaky modes is present in the optical fiber.
- These leaky modes are only partially confined to the core region & attenuated by the continuously radiating their power out of the core as they propagate along the fiber.
- A mode remains guided if the following condition is satisfied.

$$n_2 K < \beta < n_1 K$$

where  $n_1$  = Refractive index of core.

$n_2$  = Refractive index of cladding

$$k = \text{wave factor} = \frac{2\pi}{\lambda}$$

$\beta$  = Propagation factor.

### Optical Ray Theory:

#### SNELLS LAW:-

- The Snell's law state that when the light beam passes through different materials, some change in the velocity is observed.
- If the refractive index of incident medium be  $n_1$  & the refractive index of the 2<sup>nd</sup> medium be  $n_2$ , the co-efficient of refraction is given by

$$\frac{1}{\mu} = \frac{\sin i}{\sin r} = \frac{n_2}{n_1} = \frac{v_1}{v_2}$$

Where  $\mu$  = co- efficient of refraction.

$i$  = Incident angle measured for the normal of surface.

$r$  = Refracted ray angle measured for the normal to the surface.

$n_1$  = refractive index of 1<sup>st</sup> medium.

$n_2$  = refractive index of 2<sup>nd</sup> medium.

$v_1$  = velocity of light in 1<sup>st</sup> medium

$v_2$  = velocity of light in 2<sup>nd</sup> medium

- The refractive index of any medium is given by  $n = \frac{\text{velocity of light in vacuum}}{\text{velocity of light in medium}}$

$$n = \frac{\text{velocity of light in vacuum}}{\text{velocity of light in medium}}$$

- Few example of refractive indices for

For Air = 1

Glass = 1.5

Water = 1.33

Diamond = 2.43

- If for the angle of incidence (i) is such that the refracted ray angle (r) is  $90^0$ , then the incident angle is known as the critical angle.
- For any angle of incident higher than the critical angle, the total internal reflection (TIR) takes place.
- Hence the critical angle is given by

$$\theta_C = \sin^{-1} \frac{n_2}{n_1}$$

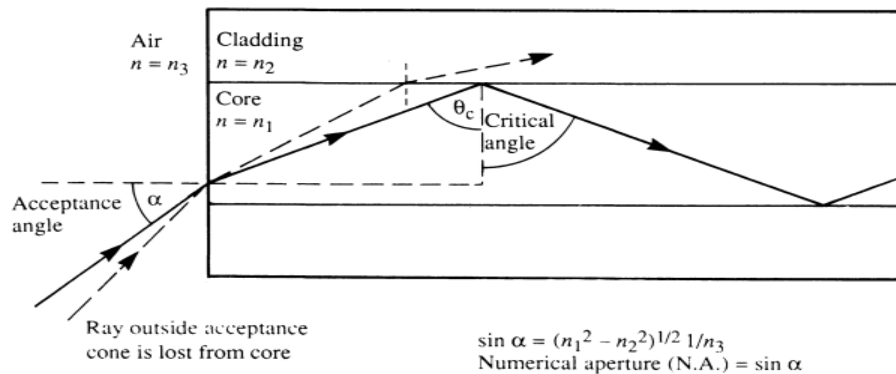

- In the figure consider the ray  $i_2$  at the critical angle  $\theta_C$  in the fiber at the core cladding boundary.
- It is observed that these rays enters the fiber core at an angle  $\theta_a$  ( $\alpha$ ) to the fiber axis and is refracted at the air-core interface before transmission to the core- cladding interface at an critical angle.
- So any ray which is incident into the fiber core at an angle greater than  $\theta_a$  (ray dotted) will be transmitted to the core cladding interface at an angle less than  $\theta_c$  and will not be totally internally reflected.
- So for light ray will be transmitted by the total refraction within the fiber core, they must be incident in the fiber core within an acceptance cone define by conical half angle  $\theta_a$ .
- Hence  $\theta_a$  is the maximum angle to the axis of the core at which light ray may enter the fiber core in order for propagation.
- It is also sometime referred as maximum or total acceptance angle for the fiber.

#### Numerical Aparature:-

- Considering the refraction at air –core interface according to Snell's law

$$n_o \sin \theta_i = n_1 \sin \theta_r$$

$$n_o \sin \theta_i = n_1 \sin (90 - \theta_c) \text{ (Limiting case)}$$

- Limiting case for total internal refraction  $\theta_i = \theta_a$  and as the incident medium is air  $n_o = 1$  applying this factors we have  $n_o \sin \theta_i = n_1 \sin (90 - \theta_c)$

$$n_o \sin \theta_a = n_1 \cos \theta_c$$

$$\begin{aligned}
&= n_1 (1 - \sin^2 \theta_c)^{1/2} \\
&= n_1 \left(1 - \frac{n_2^2}{n_1^2}\right)^{1/2} \\
&= n_1 \left(\frac{n_1^2 - n_2^2}{n_1^2}\right)^{1/2} = (n_1^2 - n_2^2)^{1/2}
\end{aligned}$$

- The numerical aperture is a dimensionless quantity having a value less than “1” and does not depend on the core dimensions.
- It establishes the relation between the acceptance angle and the refractive index of core & cladding.
- If the fractional change in the refractive index of core & cladding is given by  $\Delta = (n_1 - n_2)/n_1$   
Then the numerical aperture  $N = n_1 (2\Delta)^{1/2}$
- The typical values of  $\Delta$  are for single mode fiber  $\Delta = 0.2$  to  $1\%$  and for multi mode fiber  $\Delta = 1$  to  $3\%$ .
- Ex:- for a silicon optical fiber  $n_1 = 1.5$   $n_2 = 1.47$  calculate the critical angle, numerical aperture & maximum acceptance angle.

$$n_1 = 1.5$$

$$n_2 = 1.47$$

$$N_A = (n_1^2 - n_2^2)^{1/2} = 0.298$$

$$\theta_c = \sin^{-1}(n_2/n_1) = 78.5^\circ$$

$$\theta_a = \sin^{-1}(NA) = 17.33^\circ$$

### Optical Source:-

- The optical sources must have the following characteristics.
  - (i) The light output should be highly directional.
  - (ii) The sources should be linear (o/p light is proportional to electrical I/p current).
  - (iii) It emits light rays at desired wavelengths (850nm, 1300nm, 1550nm)
  - (iv) Must be capable of signal modulation.
  - (v) Must produce sufficient optical power.
  - (vi) Should have a narrow spectral bandwidth.
  - (vii) Must produce a stable optical output.
  - (viii) Economically cost effective & longer life span.
  - (ix) Should have very fast response.
  - (x) Should have simple driving CKT.



- The semiconductor light sources used for optical fiber communication system are two types.
  - (i) LED
  - (ii) LASER
- A PN junction that consist of direct band gap semiconductor material act as an active or re-combination region.
- When the PN junction is forward biased electron & holes are recombined either radiatively (emitting light photons) or non-radiatively (emitting heat). This is the simple LED operation.
- In Laser the photon is further processed in a resonance cavity to achieve a coherent, highly directional optical beam with narrow beam width.

**Basic LED operation:-**

**ABSORPTION:-**

- When an electron jumps from a higher energy state (CB) to a lower energy state (VB), the difference in energy ( $E_2 - E_1$ ) is radiated as a photon of energy; [ $E_g = hv$ ] either in form of light (radiating re combination) or as heat (non radiating recombination).
- If the photon energy  $hv$  of the incident light of frequency “ $\nu$ ” is about the same as the energy difference [ $E_g = E_2 - E_1$ ], the photon is absorbed by the atom which ends up in a excited state.
- In the excited atoms, electrons eventually returns to their ground state & emit light in this process light emission can occur through two fundamental process.
  - (a) Spontaneous emission.
  - (b) Stimulated emission.

(a) Spontaneous emission :-

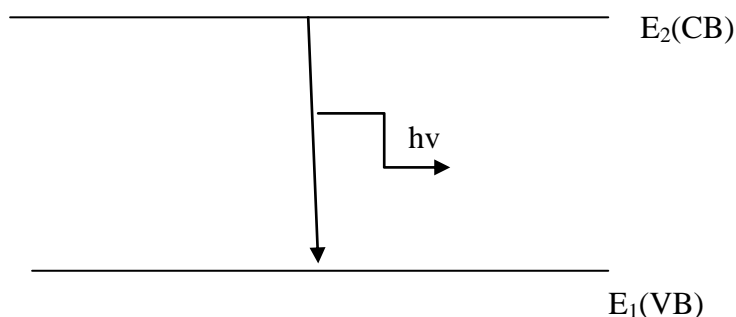

(IN LED)

- In case of spontaneous emission photons are emitted in random direction with no phase relation among them.

(b) Stimulated emission :-

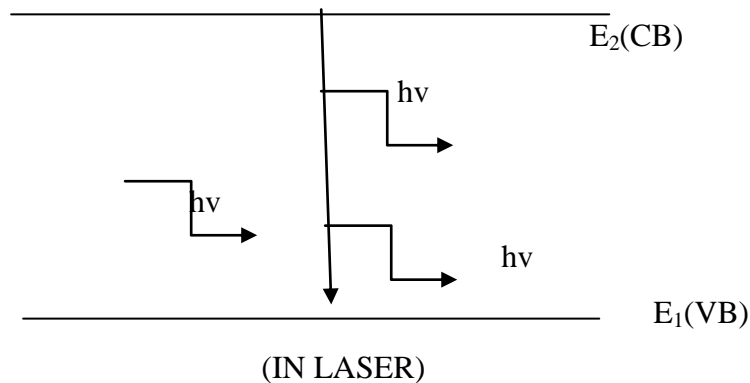

- Stimulated emission is initiated by an existing photon.
- The remarkable feature of stimulated emission is that the emitted photon matches with the original incident photon not only in energy (or frequency) but also in other characteristics such as phase & direction of propagation.
- The radiation emitted from ordinary optical sources (LED) occurs in a random manner and hence the sources are called non-coherent sources.
- In order to produce coherent optical source (Laser) & amplify the light beam, the rate of stimulated emission must be increased above the level of spontaneous emission.
- The stimulated emission must dominate over the absorption and the spontaneous emission. In a two energy level system in which the spectral density of the radiation energy at the transition frequency and the density of atoms in the upper energy level should be more or increase w.r.to. the density at lower energy level. This phenomenon is known as population inversion.
- For stimulated emission to occur the no of electrons in the conduction band must exceed the number of electrons in valence band.
- This increase to be accomplished through the process of pumping.
- Pumping means to elevate the electron from VB to CB by passing some amount of current to the active region of the laser device.
- Stimulated emission of radiation will start to take place at a minimum current level at the active region of the laser structure, called the threshold current. Below this threshold current, stimulated emission doesn't take place because radiation & absorption losses occurring inside the active region offset the additional photon generation below the threshold current.

### Double Hetero Structure Edge Emitting LED:-

- In normal PN junction in which both p- type & n- type semiconducting material are made up of same base material (Ge or Si), the recombination length of charge carriers is increased. Hence they are not confined to the vicinity of the PN junction.
- The result in carrier confinement problem to overcome this problem a thin layer is inserted between the p- type and n – type layer such that the band gap at the sandwich layer is smaller than the surrounding layer its role is to confine the carrier injected into it under forward bias.
- The carrier confinement results discontinuity of band gap at the junction between two semiconductors which have the same crystalline structure but different band gap such junctions are called hetero junction. This phenomenon is used in LEDs for carrier confinement as shown in the figure.

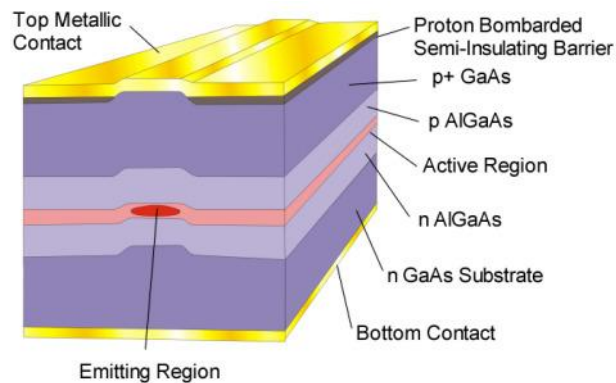

- Most of the propagating light emits at one end face only due to the reflector on the other end face and an anti reflection coating on the emitting end face.
- The two guiding layers having refractive index more than active region forms a wave guide channel that guides the optical radiation towards the fiber core.
- The emission pattern of the edge emitter is highly directional .

### Optical Laser:-

#### FEBRY PAROT RESONATOR:-

- The light amplification in the laser, when a photon colliding with an atom in the excited energy state causes the stimulated emission of a second photon & they both the photons release two more & the process goes on cumulatively.
- Continuation of this process creates avalanche multiplication, when the electromagnetic wave associated with these photons are in phase & amplified , coherent emission is obtained to achieve this laser action, it is necessary to contain photons within the laser medium & maintain the condition for coherence.

- It is performed by placing mirrors at either side of the amplifying medium.

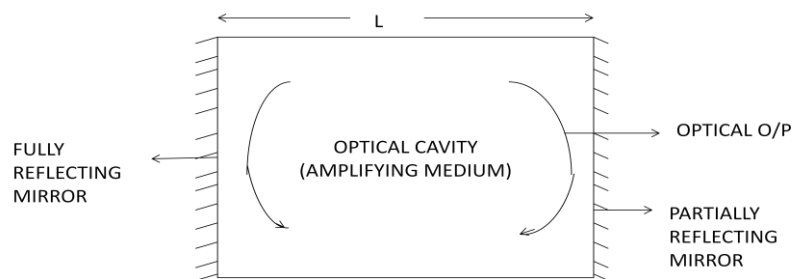

- The optical cavity so formed is more analogous to an oscillator than an amplifier and it provides the positive feedback of the photons by reflection at the mirror at either end of the cavity. Hence the optical signal is feedback many times while receiving amplification as it passes through the medium.
- A stable o/p is obtained when the optical gain is equal to the total losses occurred in the amplifying medium.

### Photo Detector

- The photo detector senses the luminance power (optical radiation) falling on it & convert the variation of this optical power into a corresponding variable electric current.
- In general P-I-N diodes or APD (Avalanche photo diode) are used in photo detector.

### P-I-N Diode:

- A simple way to increase the depletion region width is to insert a pure semiconductor material (Intrinsic semiconductor) between the PN junctions.
- Since the middle layer consists of intrinsic material, such structure is known as P-I-N diode. Because of the intrinsic nature of the middle layer, it offers a high resistance & most of the voltage drop occurs across it. As a result, a large electric field exists across the "I" layer.
- So the depletion region extends throughout the "I" region & its width "W" can be controlled by changing the middle layer thickness.
- The optimum value of "W" depends on a compromise between speed & sensitivity of the photo detector.

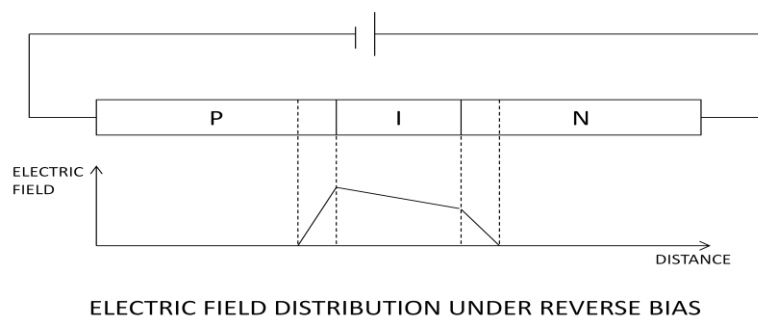

## Avalanche photo diode (APD)

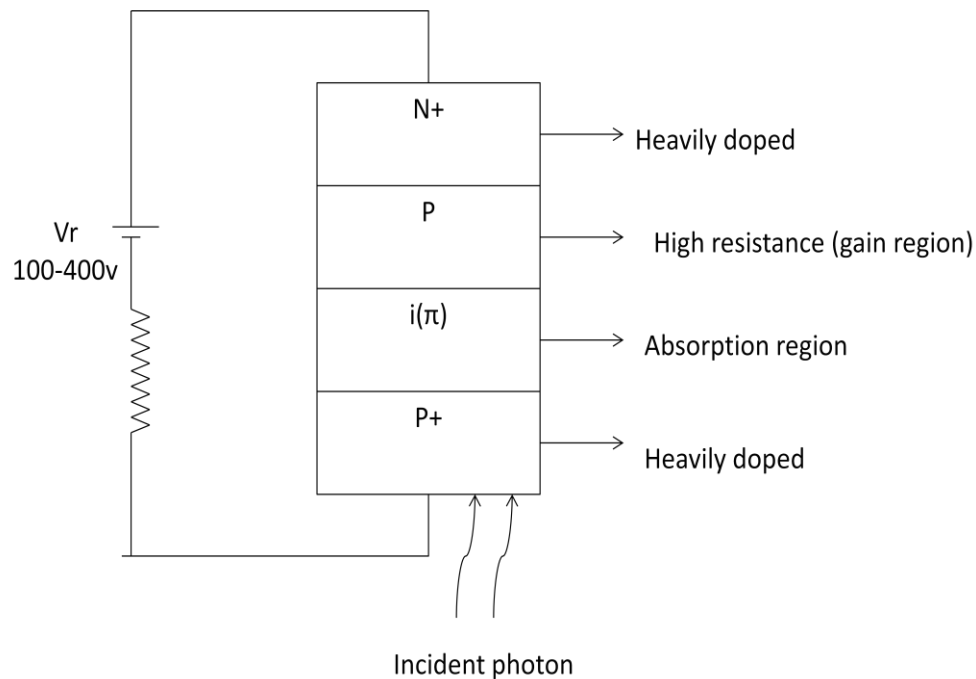

- In APD we require high reverse bias voltage (100 to 400V) which creates an extremely high electric field region approximately  $3 \times 10^5$  V/cm. In the depletion region here most of the photons are absorbed & the primary carrier pairs are generated.
- Due to the high electric field region, the charge carriers acquire sufficient energy to excite new carrier pairs. This process is known as Impact Ionization & this leads to avalanche breakdown in ordinary diodes.
- The high potential is required in order to create new carriers by impact ionization. The carrier multiplication factor achieved by this process is of the order of  $10^4$ .
- Although the APD is more sensitive than the P-I-N diodes but it is very costly & complex driving ckt limits its use for high end applications.

## Wavelength Division Multiplexing (WDM):-

- The optical fiber cable is capable of carrying the data over a very wide spectral band width.
- To utilize the entire band width efficiently, multiple signals of lesser bandwidth are sent simultaneously over the optical link. Since the light sources used can emit a narrow wavelength band, many such sources can be coupled a single fiber simultaneously in different segments of this wavelength range.
- The technology of combining a no of such independent information carrying wavelength on to a single fiber is known as wavelength division multiplexing.

- For practical purposes a variety of wavelength tunable components are used to produce different wave length for signal transmission over a single channel.
- The application of wavelength division multiplication technique includes long distance terrestrial communication, under Sea transmission system & metro networks etc.
- The use of “WDM” allows different signals in different coding to be sent simultaneously & independently over a fiber without the need for a common signal structure at higher data rates.

#### OPERATION

- In WDM, the discrete wavelengths forms an orthogonal set of carriers which can be separated, routed & switched without interfering with each other.
- This isolation between the channels holds as long as the total optical power intensity is kept low to prevent scattering & wave mixing.
- The implementation of “WDM” network requires both passive and active devices to combine, distribute, isolate & amplify optical power at different wave length.
- The passive devices require no external control for their operation where as the active devices can be control electrically & optically, thereby providing a large degree of network flexibility.
- The active WDM components include tunable optical filters, tunable sources & optical amplifiers.
- The following figure shows the implementation of a typical WDM link.

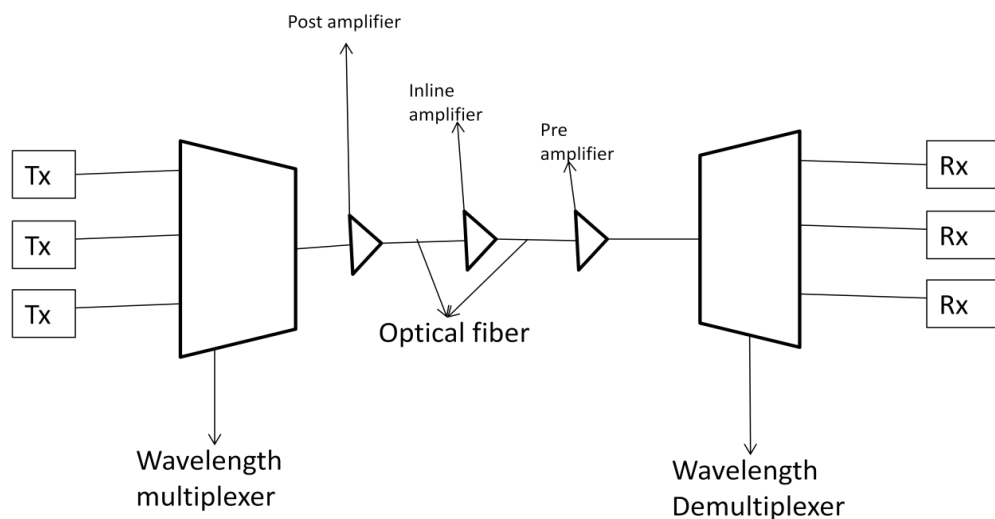

- At the transmitting end there are several independently modulated light sources each emitting signal at a unique wavelength. Here a multiplexer is required to combining these optical outputs into a continuous spectrum of signal which is further coupled to a single fiber.

- The optical signal is amplified intermittently by the repeaters in the channel.
- At the receiving end a de-multiplexer is required to separate the optical signals into appropriate detection channels for signal processing.
- The operational frequency band allocated to a particular light source ranges from 25 to 100 GHz (0.25 to 0.8 nm).

# TELEPHONE SWITCHING SYSTEM

## **Introduction:-**

The telephone system provides the means to pass the information from one terminal (calling subscriber) to other terminal (Called Subscriber).

The telecommunication system broadly comprises of following basic elements.

- (1) End instrument or Telephone set.
- (2) Transmission system or connecting cables.
- (3) Switching system or Exchange.
- (4) Signaling.

The end instruments are responsible for transmitting and receiving the audio signal or data.

The end instrument may be telephone handset or computer system.

## **Telephone Handset:-**

The telephone is basically a trans-receiver. The transmitter of telephone converts the audio signal to an equivalent electrical signal and the receiver converts the electrical signal into audio signal.

The Circuit of a telephone base unit is shown in the figure below.

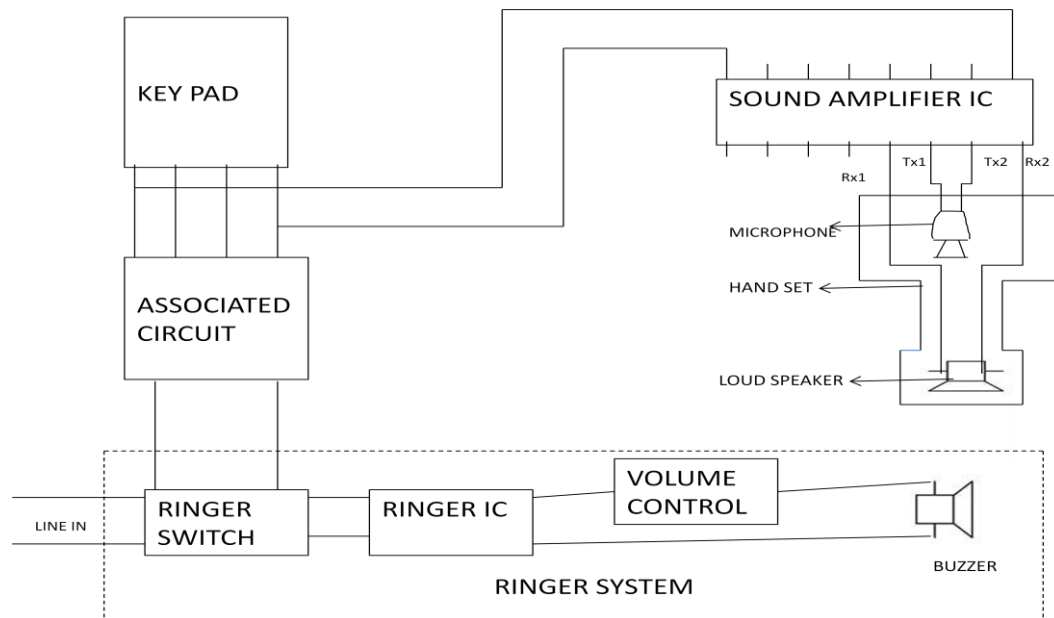

The modern telephone set consist of

- |                                   |                            |
|-----------------------------------|----------------------------|
| (i) Key pad along with dialer IC. | (iv) Ringer IC.            |
| (ii) Sound Amplifier IC.          | (v) Buzzer volume control. |
| (iii) Associated ckt.             | (vi) Buzzer.               |
|                                   | (vii) Ringer switch.       |



### Ringer:-

- Ringer is a device that alerts the called subscriber. The original equipment includes an electromagnet and a ringer to generate AC signal.
- This signal produces the ringing alarm.
- Now a days the ringing signals are sent by the exchange.
- When a calling subscriber calls another subscriber, the exchange relays are activated and the ringing signal having frequencies 20KHz are passed to the called subscriber.
- Modern ringer system which includes ringer switch, ringer IC, and ringer volume control with Buzzer.
- Popular ringer ICS are KA2418-B, LS1240, HA 31002P.

### Hand Set:-

The handset connected to the sound amplifier IC can be broadly divided into two parts.

(I) Transmitter section

(II) Receiver section.

### Transmitter:-

- The transmitter section consists of a carbon microphone.
- One side of the enclosure is flexible and connected to a mechanical diaphragm.
- When the sound wave impinges this diaphragm, it oscillates or vibrates resulting in an uneven distribution of the carbon granules. This in turn changes the resistance of the carbon microphone.
- If a voltage is applied to the microphone, this variation in resistance will vary the current through the CKT proportionality.
- Hence the variation in current is proportional to the resistance of carbon Micro Phone which is further proportional to the vibration of the diaphragm in turn proportional to the audio signal.
- The voltage required to charge the carbon granules is provided from the exchange which comes from the central battery system.
- The minimum current is required for the proper operation of carbon microphone is 23 mAmp and a voltage level maintain is 42 to 60 volts (48 volt practically)
- The central battery provides the following
  - (i) AC ringing voltage for buzzer.
  - (ii) Metallic path to provide charge to carbon granules.
  - (iii) Generates the pulsating DC current during dialing.

Receiver:-

- The varying signal from the calling subscriber is coupled to the receiver of called subscriber.
- The receiver is an electromagnet with attached magnetic diaphragm.
- The diaphragm is made of cobalt iron & slightly conical in shape in order to provide a uniform pressure distribution on the ear drum.

The dialing unit:-

There are two dialing methods used in telephone system.

(I) Pulse dialing.

(II) Multi frequency dialing.

- In pulse dialing a rotary dial is used in this system a train of pulses is used to represent a single digit of the called subscriber no.
- In multi frequency dialing, pair of tones is attached to each digit being dialed. It is also called as touch tone dialing or dual tone multi frequency dialing (DTMF)

Sound Amplifier:-

- The two wires of transmitter and receiver are connected to the sound and speech IC for effective transmission and receiving of audio signal.
- This IC performs the following functions.
  - (a) Automatic gain control.
  - (b) Dial tone.
  - (c) Biasing.

**The switching office performs the following functions.**

- (i) Identification of the calling subscriber.
  - (ii) Addressing.
  - (iii) Finding and setting of the path between calling subscriber & called subscriber.
  - (iv) Busy Testing.
  - (v) Inter connection.
  - (vi) Alerting
  - (vii) Supervision
  - (viii) Clear down
  - (ix) Billing
- (I) Identification of calling subscriber :-
- The local switching centre must react to a calling signal from calling subscriber and must be able to receive information to identify the destination terminal.

➤ The calling signal is sometimes called as seize.

(II) Addressing :-

➤ The switching system must be able to identify the called subscriber from the information from calling subscriber.

➤ The address may be of same local exchange or some other exchange.

➤ If the terminal (called subscriber) or the trunk is busy, then a suitable signal must be returned to the calling subscriber.

(III) Finding & setting of the path

➤ Once the calling subscriber destination is identified and the called subscriber is available, an accept signal is passed to the switching system & calling subscriber.

(IV) Busy testing :-

➤ If the no dialed by the calling subscriber is wrong or the called subscriber is busy or the terminal may be free but no response is received then a switching system has to pass a corresponding voice message or a busy tone after waiting for a certain interval of time.

(V) Interconnection :-

➤ For a call between two subscribers, three connections are to be made.

(i) From local exchange & called subscriber.

(ii) From local exchange to other Exchange.

(iii) From calling subscriber to local exchange.

(VI) Alerting :-

➤ Once the connection was made, the system sends a signal to alert the called subscriber to pick up the hand set.

(VII) Supervision :-

➤ Once the path between calling subscriber & called subscriber is established, it should be supervised in order to detect the communication and clear down conditions for recoding the billing information.

(VIII) Clear down :-

➤ When the call established is completed, the path between the calling subscriber should be disconnected.

➤ If the calling subscriber keeps down the handset 1<sup>st</sup>, the signal called clear backward signal is passed to the switching system.

➤ By receiving this clear down signal, the switching system disconnects the path between the calling subscriber and the called subscriber.

(IX) Billing:

- A switching system should have a mechanism to monitor and count the no of units made during the conversation.
- The cumulative no of units made for a particular direction by the calling subscriber is calculated.
- This information is send for billing purpose to the calling subscriber.

**The function of an exchange for providing a call between two subscribers**

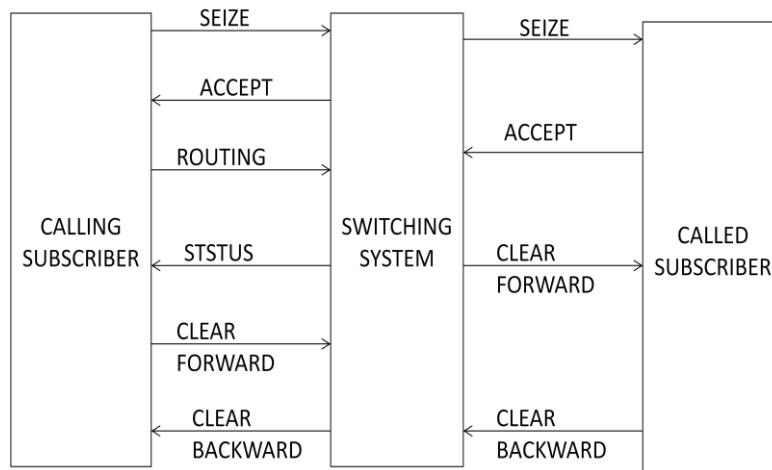

**Types of Switching:-**

- There are three classes of switching system based on the division of information in space, time, & frequency domain.
- Accordingly there called as
  - (i) Space division switching.
  - (ii) Time division switching.
  - (iii) Freq division switching.

(I) Space division switching :-

- The space division switching method provides a fixed path for the entire duration of a call.
- The advantages of space division switching are
  - (i) Simple configuration.
  - (ii) Unlimited bandwidth.
  - (iii) Limited crosstalk probability.
- But this switching method is very slow to operate, bulky and involves large amount of wiring.

## (II) Time Division Switching:-

- In time division switching all the I/P and O/P of the switching center are connected to a common switching mechanism.
- The switch connects certain pair of I/P & o/p for a short duration.
- Each I/p is sampled to change the connecting pattern hence the switching is first and compact is used the circuit becomes simple to operate.
- The various switching elements used for time division switching are
  - (i) Conventional relays.
  - (ii) Reed relays.
  - (iii) Uni-selectors
  - (iv) Two motion selectors etc.
- The conventional relays are simple electrical or electro mechanical relays used for switching.
- To perform switching, the relays act as a cross point.
- The reed relays are electro mechanical switches used in modern switching equipments. They are faster than conventional relays but they required a large current to operate.
- Mercury wetted reed relays & dry reed relays are mostly used in the modern common system.

## (III) Frequency Division Switching:-

- In this switching system, the incoming signal is modulated with different carrier frequencies.
- The switching is achieved by using the demodulators operating at different frequency bands at receiver side.
- Other than radio communication, this switching system does not have any practical applications.
- This switching system is also used in certain application of satellite common system.

## Unit Of Power Measurement

- In the telephone common system normally the logarithmic scale is the measure of power consumed & the units expressed in 'dB' or 'dBm'

$$P_{dB} = 10 \log \frac{(p_2)watts}{(p_1)watts}$$

$$P_{dBm} = 10 \log \frac{(p_2)watts}{(p_1)m\ watts}$$

- There is also another unit called Neper for power measurement.

$$1 \text{ ne per} = 8.69 \text{ db}$$

- For any switching system if the input power is  $16 \mu\text{ watt}$  and o/p is  $30 \text{ m watt}$ . Find the power in decibel db & neper.

$$\text{I/P } p_1 = 16 \mu\text{w} = 16 \times 10^{-6} \text{ watt}$$

$$\text{o/p } p_2 = 30 \text{ m watt} = 30 \times 10^{-3} \text{ watt}$$

$$p_{\text{db}} = 10 \log \frac{30 \times 10^{-3}}{16 \times 10^{-6}}$$

$$= 32.73 \text{ db.}$$

$$1 \text{ nep} = 8.69$$

$$= 3.76$$

$$P_{\text{dbm}} = 10 \log \frac{(p_2) \text{ watts}}{(p_1) \text{ m watts}}$$

$$= 62.7 \text{ dbm}$$

- Q. An amplifier has an I/P resistance of  $600 \Omega$  & a resistive load of  $75 \Omega$ . When it has an I/P voltage  $100 \text{ mV rms}$ . The o/p current is  $20 \text{ mA rms}$  find the gain of the amplifier in db.

Ans: I/P voltage =  $100 \text{ mV} = 100 \times 10^{-3} \text{ V}$

I/P current =  $20 \text{ mA} = 20 \times 10^{-3} \text{ A}$

I/P Resistance =  $600 \Omega$

o/p Resistance =  $75 \Omega$

$$\text{I/P Power} = \frac{v_{\text{in}}^2}{R} = \frac{(100 \times 10^{-3})^2}{600}$$

$$= 0.016 \times 10^{-3}$$

$$\text{O/p power} = I^2 R$$

$$= (20 \times 10^{-3})^2 \times 75$$

$$= 0.03 \text{ watt}$$

$$P_{\text{db}} = 10 \log \frac{P_2}{P_1} \text{ watt}$$

$$= 10 \log \frac{0.03}{0.016 \times 10^{-3}}$$

$$= 32.72 \text{ db}$$

$$\text{Dbm} = 10 \log \frac{P_2 \text{ watt}}{P_1 \text{ m watt}}$$

$$= 62.73 \text{ dbm}$$

## Operation PBX & Digital EPABX.

PBX stands for Private Branch Exchange, which is a private telephone network used within a company or organization. The users of the PBX phone system can communicate within their company or organization and the outside world, using different communication channels like Voice over IP, ISDN or analog. A PBX also allows you to have more phones than physical phone lines (PTSN) and allows free calls between users. It also provides features like transfers, voicemail, call recording, interactive voice menus (IVRs) and ACD call queues.

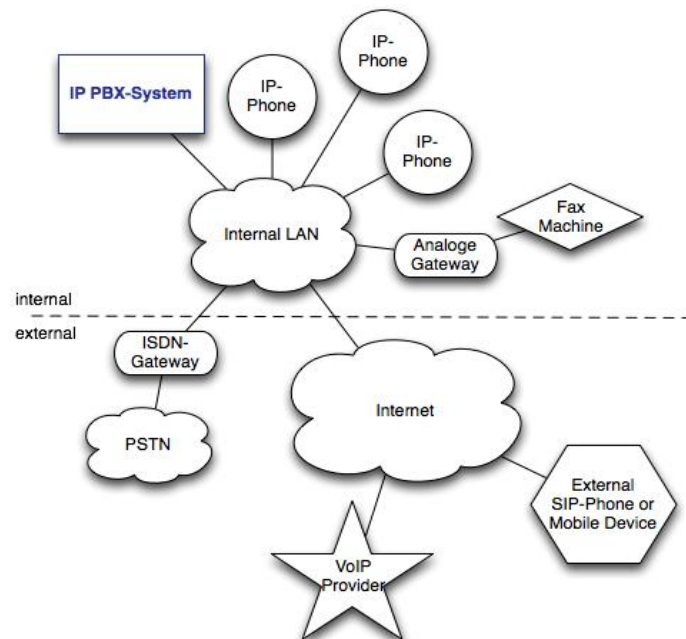

PBX phone systems are available as Hosted or Virtual solutions (sometimes also called Centrix), and as inhouse solutions to be used on your own hardware. PBX phone systems are usually much more flexible than proprietary systems, as they are using open standards and interfaces. Modern PBX phone systems are based on standard hardware, which is cheaper and can easier be replaced than a closed systems.

Switching to an IP PBX offers many benefits. With an IP phone system all your internal telephony is routed through the existing LAN (local computer network). This way a separate network for telephony is not required. Even though the internal telephony is routed through the LAN, it is also possible to connect your IP-PBX via gateways to the PSTN. Of course, VoIP (Voice over IP, telephony via the internet) is also possible.

Since IP telephony is mostly using the open SIP standard, an IP phone system gives you a lot more freedom in your choice of phones. Basically any SIP compatible phone (VoIP phone) will work with an IP PBX. Furthermore an IP PBX doesn't limit the growth of a company.

Since VoIP phones don't have to be connected physically to the phone system, it doesn't require a free port in the phone system like it used to be with traditional phone systems. IP phones can not only be connected via the LAN but also via the internet, using for example a VPN connection. Because of this, multiple locations and offices can easily be connected. There is a huge variety of VoIP providers on the internet which provide SIP trucking (telephony services) for cheaper call rates than traditional telephony providers. Internal calls via an IP phone system are free general.

#### Practical advantages of IP telephony:

Interconnecting teams and mobile working is one of the huge advantages of IP phone systems. No matter if team members are on the road, are located in a different country or work from home, they can connect via IP desk phone, smart phone or laptop to the PBX in the office. This way all calls within the company are free and clients will not realize if an employee is in the office or somewhere else around the world. The same also applies for conferences, these can be hosted directly on the own IP PBX with as many participants as required. This saves traveling time and money.

#### Digital EPABX

As shown in the figure EPABX/PBX facilitates use of one external telephone line by many internal users in the office premises. In the office each employee is provided one telephone set and all the telephones are connected with PBX.

All the employees within the office premises can communicate using 3-digit or 4-digit number programmed in EPABX/PBX without any charge.

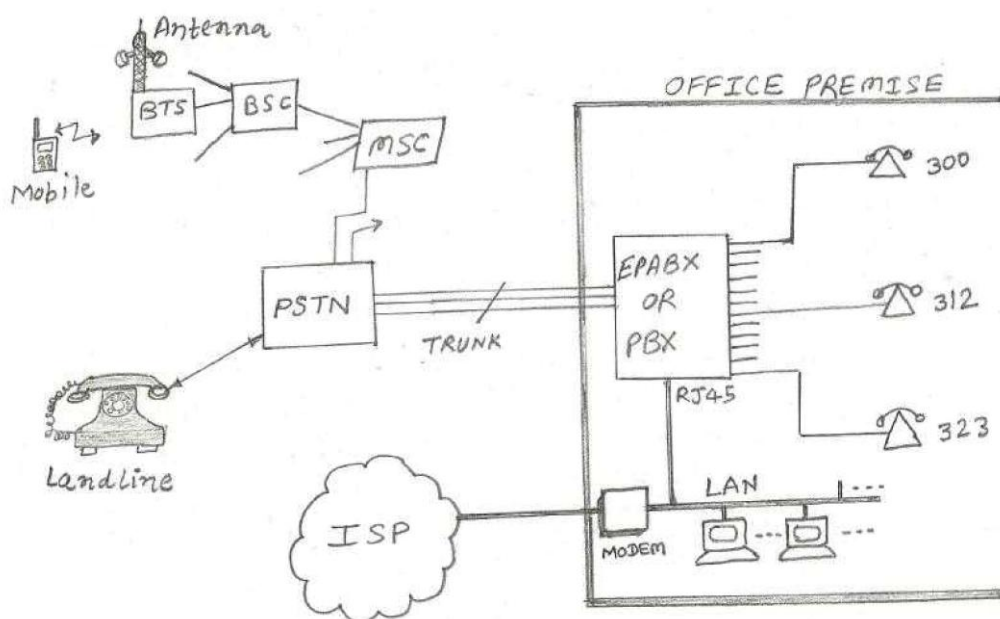



EPABX/PBX is connected to PSTN (Public switched Telephone network) via trunk lines; hence all can use one external voice line in time shared basis.

PSTN is connected with MSC (Mobile switching centre) of cellular networks such as GSM/CDMA/UMTS. By this mobile cell phone user can connect to any telephone set in the office premises using extension number.

Similar to voice line EPABX/PBX can be used for Data applications. As shown in figure Data port of PBX is connected to LAN where so many PCs are connected and are using same external internet connection line from ISP via Modem/router. The same facility of PBX can extended for WLAN users too.

### **Telephone Numbering System:-**

- It is a type of numbering scheme used in telecommunication to allocate a specific number to each subscriber so that the telephone calls can be routed from calling subscriber to called subscriber through the telephone network.
- There are basically two types of numbering plans.
  - (1) Closed numbering plan.
  - (2) Open numbering plan.
- The closed numbering plan is used for the telephone system normally deployed for household applications.
- They are having a free length number allocated to each user.
- The open numbering plan is a variable length numbering system generally used for large office or organization using the PBX or EPBX system.
- A dial plan establishes the expected number and pattern of digits for a telephone number.
  - (a) Country code.
  - (b) Area code.
  - (c) Local port code.
- The public switch telephone network (PSTN) system uses a 10 digit dial plan including 3digit area code and 7 digit telephone number.
- The PSTN system follows E:164 standards which include
  - (a) Country calling code (ISD Code)
  - (b) Area code (STD Code)
  - (c) Local no.

(a) COUNTRY CALLING CODE:-

- It is necessary only when dialing to phone in other countries.
- In international use, the telephone numbers are prefixed with the country code along with a '+' sign with spaces in place of hyphen.
- Ex – Tey + [  $\frac{XX}{\quad} \frac{YYY}{\quad} \frac{ZZZ}{\quad} \frac{ZZZ}{\quad}$  ]
- This format allows the user to choose the exchange code need to dial from its location.
- For GSM network '+' is an actual character that may be used internally as the international access code.

AREA CODE:-

- These are known as numbering plan areas (NPA) and formally known as STD codes.
- These are necessary only when the dialled number is from outside the area code.
- These usually indicate geographical areas within one country that covers 100's of in the dial string by the national access code (04 India & 1 for USA) or the international access code and local number.
- The local number or subscriber number must always be dialled entirely.
- The 1<sup>st</sup> few digits indicate the local telephone exchange no followed by the subscriber no.
- For short range calling, the subscriber need not include the area code or country code in the dialed no. string which enables shorter digital string.

**Internet Telephony:**

- Internet telephony, also known as voice-over-IP, replaces and complements the existing circuit- switched public telephone network with a packet-based infrastructure.
- Internet telephony supports communications services such as voice, facsimile, and/or Voice-messaging applications – that are transported via the Internet, rather than the public switched telephone network (PSTN).
- The basic steps involved in originating an Internet telephone call are conversion of the analog voice signal to digital format and compression/translation of the signal into Internet protocol (IP) packets for transmission over the Internet; the process is reversed at the receiving end.
- More technically, Internet telephony is the real-time delivery of voice and possibly other multimedia data types between two or more parties, across networks using the Internet protocols, and the exchange of information required to control this delivery.
- One of the strengths of Internet telephony is the ability to be *media-neutral*, that is, almost the entire infrastructure does not need to change if a conversation includes video,

shared applications or text chat.

- In this system the call goes over the local PSTN network to the nearest gateway server, which digitizes the analog voice signal, compresses it into IP packets and moves it through the internet gateway for transporting to the receiving end.
- It supports computer to telephone calls, telephone to computer calls and telephone to telephone calls.
- It offers tremendous cost saving as compared to the PSTN system for long distant calls.
- It finds the problem of less reliable data communication and lower sound quality due to limited bandwidth operation and current data compression techniques used.
- The first widely used standardized signaling protocol was provided by the ITU in 1996, as the H.323 family of protocols.

#### **Internet Protocol (IP) Telephony:**

- IP telephony is the superset of Internet telephony, as it refers to all telephony services over IP, rather than just those carried across the Internet.
- In IP telephony, streaming media requires synchronous data delivery where the short-term average delivery rate is equal to the native media rate, but streaming media can often be buffered for significant amounts of time, up to several seconds, without interfering with the service.
- In IP telephony, the source is generally a human being and, more importantly, there is bidirectional real-time media interaction between the parties.
- In the area of IP telephony, 3GPP, the 3rd Generation Partnership Project, has been driving the standardization for third generation wireless networks using “based on evolved GSM core networks and the radio access technologies that they support.” It consists of a number of organizational partners, including ETSI. A similar organization, 3GPP2, deals with radio access technologies derived from the North American CDMA (ANSI/TIA/EIA-41) system; it inherits most higher-layer technologies, such as those relevant for IP telephony, from 3GPP.

# DATA COMMUNICATION

## **Introduction to Data Communications:**

In Data Communications, data generally are defined as information that is stored in digital form. Data communications is the process of transferring digital information between two or more points. Information is defined as the knowledge or intelligence. Data communications can be summarized as the transmission, reception, and processing of digital information. For data communications to occur, the communicating devices must be part of a communication system made up of a combination of hardware (physical equipment) and software (programs). The effectiveness of a data communications system depends on four fundamental characteristics: delivery, accuracy, timeliness, and jitter.

A data communications system has five components:

1. **Message:** The message is the information (data) to be communicated. Popular forms of information include text, numbers, pictures, audio, and video.
2. **Sender:** The sender is the device that sends the data message. It can be a computer, workstation, telephone handset, video camera, and so on.
3. **Receiver:** The receiver is the device that receives the message. It can be a computer, workstation, telephone handset, television, and so on.
4. **Transmission medium:** The transmission medium is the physical path by which a message travels from sender to receiver. Some examples of transmission media include twisted-pair wire, coaxial cable, fiber-optic cable, and radio waves.
5. **Protocol:** A protocol is a set of rules that govern data communications. It represents an agreement between the communicating devices.

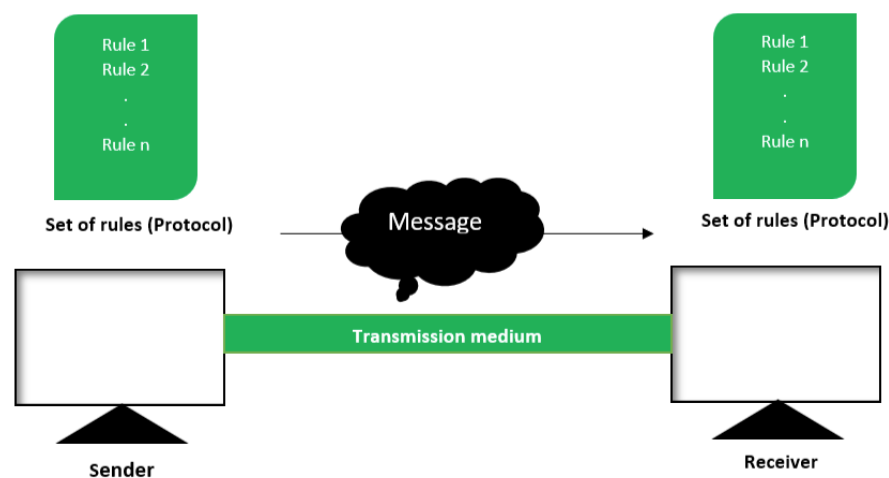

## **Standards Organizations for Data Communications**

An association of organizations, governments, manufacturers and users form the standards organizations and are responsible for developing, coordinating and maintaining the standards. The intent is that all data communications equipment manufacturers and users comply with these standards. The primary standards organizations for data communication are:

### **1. International Standard Organization (ISO)**

ISO is the international organization for standardization on a wide range of subjects. It is comprised mainly of members from the standards committee of various governments throughout the world. It is even responsible for developing models which provides high level of system compatibility, quality enhancement, improved productivity and reduced costs. The ISO is also responsible for endorsing and coordinating the work of the other standards organizations.

### **2. International Telecommunications Union-Telecommunication Sector (ITU-T)**

ITU-T is one of the four permanent parts of the International Telecommunications Union based in Geneva, Switzerland. It has developed three sets of specifications: the V series for modem interfacing and data transmission over telephone lines, the X series for data transmission over public digital networks, email and directory services; the I and Q series for Integrated Services Digital Network (ISDN) and its extension Broadband ISDN. ITU-T membership consists of government authorities and representatives from many countries and it is the present standards organization for the United Nations.

### **3. Institute of Electrical and Electronics Engineers (IEEE)**

IEEE is an international professional organization founded in United States and is compromised of electronics, computer and communications engineers. It is currently the world's largest professional society with over 200,000 members. It develops communication and information processing standards with the underlying goal of advancing theory, creativity, and product quality in any field related to electrical engineering.

### **4. American National Standards Institute (ANSI)**

ANSI is the official standards agency for the United States and is the U.S voting representative for the ISO. ANSI is a completely private, non-profit organization comprised of equipment manufacturers and users of data processing equipment and

services. ANSI membership is comprised of people from professional societies, industry associations, governmental and regulatory bodies, and consumer goods.

5. Electronics Industry Association (EIA)

EIA is a non-profit U.S. trade association that establishes and recommends industrial standards. EIA activities include standards development, increasing public awareness, and lobbying and it is responsible for developing the RS (recommended standard) series of standards for data and communications.

6. Telecommunications Industry Association (TIA)

TIA is the leading trade association in the communications and information technology industry. It facilitates business development opportunities through market development, trade promotion, trade shows, and standards development. It represents manufacturers of communications and information technology products and also facilitates the convergence of new communications networks.

7. Internet Architecture Board (IAB)

IAB earlier known as Internet Activities Board is a committee created by ARPA (Advanced Research Projects Agency) so as to analyze the activities of ARPANET whose purpose is to accelerate the advancement of technologies useful for U.S military.

IAB is a technical advisory group of the Internet Society and its responsibilities are:

- I. Oversees the architecture protocols and procedures used by the Internet.
- II. Manages the processes used to create Internet Standards and also serves as an appeal board for complaints regarding improper execution of standardization process.
- III. Responsible for administration of the various Internet assigned numbers
- IV. Acts as a representative for Internet Society interest in liaison relationships with other organizations.
- V. Acts as a source of advice and guidance to the board of trustees and officers of Internet Society concerning various aspects of internet and its technologies.

8. Internet Engineering Task Force (IETF)

The IETF is a large international community of network designers, operators, vendors and researchers concerned with the evolution of the Internet architecture and smooth operation of the Internet.

## 9. Internet Research Task Force (IRTF)

The IRTF promotes research of importance to the evolution of the future Internet by creating focused, long-term and small research groups working on topics related to Internet protocols, applications, architecture and technology.

### Data Communication Circuits

- The underlying purpose of a digital communications circuit is to provide a transmission path between locations and to transfer digital information from one station (node, where computers or other digital equipment are located) to another using electronic circuits.
- Data communications circuits utilize electronic communications equipment and facilities to interconnect digital computer equipment.
- Communication facilities are physical means of interconnecting stations and are provided to data communications users through public telephone networks (PTN), public data networks (PDN), and a multitude of private data communications systems.

The following figure shows a simple two-station data communications circuit. The main components are:

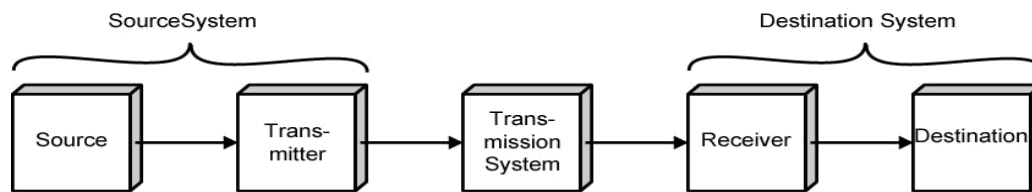

(a) General block diagram

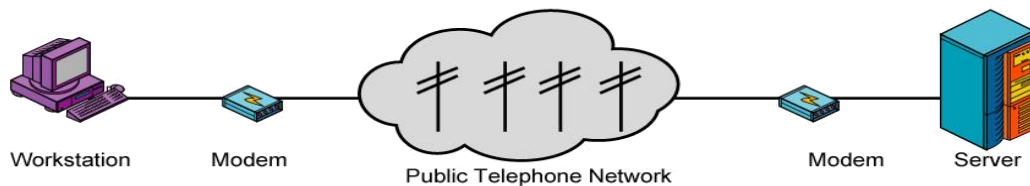

(b) Example

**Source:** - This device generates the data to be transmitted; examples are mainframe computer, personal computer, workstation etc. The source equipment provides a means for humans to enter data into system.

**Transmitter:** - A transmitter transforms and encodes the information in such a way as to produce electromagnetic signals that can be transmitted across some sort of transmission system. For example, a modem takes a digital bit stream from an attached device such as a personal computer and transforms that bit stream into an analog signal that can be handled by the telephone network.

**Transmission medium:** - The transmission medium carries the encoded signals from the transmitter to the receiver. Different types of transmission media include free-space radio transmission (i.e. all forms of wireless transmission) and physical facilities such as metallic and optical fiber cables.

**Receiver:** - The receiver accepts the signal from the transmission medium and converts it into a form that can be handled by the destination device. For example, a modem will accept an analog signal coming from a network or transmission line and convert it into a digital bit stream.

**Destination:** - Takes the incoming data from the receiver and can be any kind of digital equipment like the source.

### **Serial and Parallel Data Transmission**

- There are two methods of transmitting digital data namely parallel and serial transmissions.
- In parallel data transmission, all bits of the binary data are transmitted simultaneously. For example, to transmit an 8-bit binary number in parallel from one unit to another, eight transmission lines are required. Each bit requires its own separate data path. All bits of a word are transmitted at the same time. This method of transmission can move a significant amount of data in a given period of time. Its disadvantage is the large number of interconnecting cables between the two units. For large binary words, cabling becomes complex and expensive. This is particularly true if the distance between the two units is great. Long multi wire cables are not only expensive, but also require special interfacing to minimize noise and distortion problems.
- Serial data transmission is the process of transmitting binary words a bit at a time. Since the bits time-share the transmission medium, only one interconnecting lead is required. While serial data transmission is much simpler and less expensive because of the use of a single interconnecting line, it is a very slow method of data transmission.
- Serial data transmission is useful in systems where high speed is not a requirement. Parallel communication is used for short-distance data communications and within a computer, and serial transmission is used for long-distance data communications.



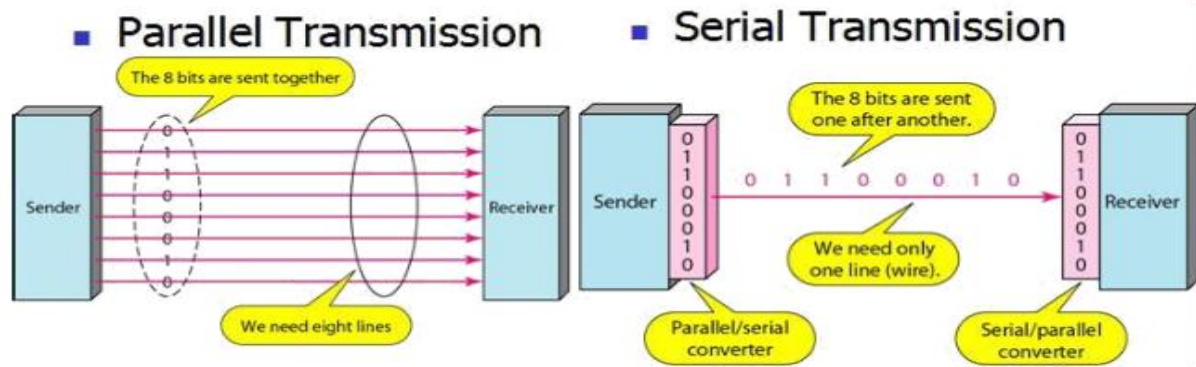

## Transmission Modes

There are four modes of transmission for data communications circuits:

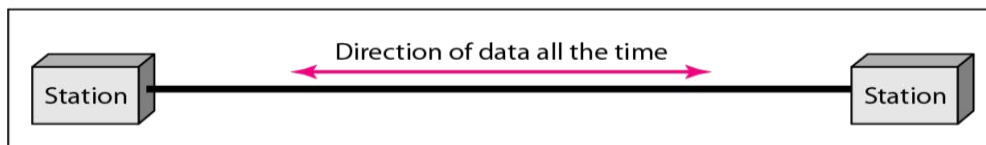
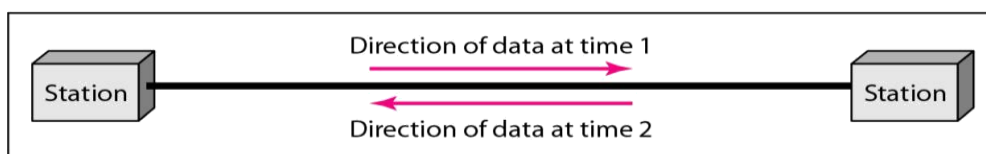
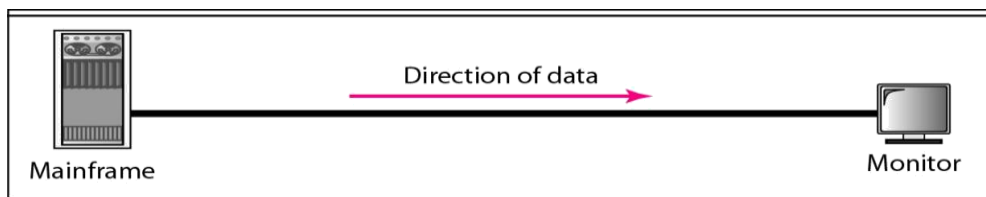

- In simplex mode (SX), the communication is unidirectional, as on a one-way street. Only one of the two devices on a link can transmit; the other can only receive. Commercial radio broadcasting is an example. Simplex lines are also called receive-only, transmit-only or one-way-only lines.
- In half-duplex(HDX) mode, each station can both transmit and receive, but not at the same time. When one device is sending, the other can only receive, and vice versa. The half-duplex mode is used in cases where there is no need for communication in both directions at the same time; the entire capacity of the channel can be utilized for each direction. Citizens band (CB) radio is an example where push to talk (PTT) is to be pressed or depressed while sending and transmitting.
- In full-duplex mode(FDX) (called duplex), both stations can transmit and receive simultaneously. One common example of full-duplex communication is the telephone

network. The full-duplex mode is used when communication in both directions is required all the time. The capacity of the channel must be divided between the two directions.

- In full/full duplex (F/FDX) mode, transmission is possible in both directions at the same time but not between the same two stations (i.e. station 1 transmitting to station 2, while receiving from station 3). F/FDX is possible only on multipoint circuits. Postal system can be given as a person can be sending a letter to one address and receive a letter from another address at the same time.

### **Data Communications Codes**

- Data communications codes are used to represent characters and symbols such as letters, digits and punctuation marks.
- Data communications codes are called character codes, character sets, symbol codes or character languages.
- The relationship of bytes to characters is determined by a *character code*.
- Each time a user presses a key on a terminal/PC, a binary code is generated for the corresponding character.
- Various character codes have been used in data communication including: Morse, Baudot code, EBCDIC, ASCII Unicode

### **Baudot Code**

- The Baudot code (sometimes called the Telex code) was the first fixed-length character code. One of first codes developed for machine to machine communication.
- It uses 1's and 0's instead of dots and dashes. It was used for transmitting telex messages (punch tape). Few important characteristics of these codes are:
  - Fixed character length (5-bits)
  - 32 different codes
  - increased capacity by using two codes for shifting
  - 11111 (32)          Shift to Lower (letters)
  - 11011 (27)        Shift to Upper (digits, punctuation)
  - 4 special codes for SP, CR, LF & blank
  - Total = 26 + 26 + 4 = 56 different characters

Limitations:

- required shift code to switch between character sets
- no lower case, few special characters

- no error detection mechanism
- characters not ordered by binary value
- designed for transmitting data, not for data processing

#### International Baudot

- Added a 6th bit for parity
- Used to detect errors within a single character

#### **ASCII Code**

- American Standard Code for Information Interchange.
- 7-bit code developed by the American National Standards Institute (ANSI).
- most popular data communication character code today.
- Allows for 128 different character representations ( $2^7$ ).
- includes upper and lower case.
- lots of special characters (non-printable).
- generally used with an added parity bit.
- better binary ordering of characters than EBCDIC.
- Extended ASCII uses 8 data bits and no parity
- Used for processing and storage of data.
- Allows for international characters.
- 8th bit stripped of for transmission of standard character set.

#### **EBCDIC Code**

- Extended Binary Coded Decimal Interchange Code.
- 8-bit character code developed by IBM.
- Used for data communication, processing and storage.
- Extended earlier proprietary 6-bit BCD code.
- Designed for backward compatibility or marketing?
- Still in use today on some mainframes and legacy systems.
- Allows for 256 different character representations ( $2^8$ ).
- Includes upper and lower case.
- Lots of special characters (non-printable).
- Lots of blank (non-used codes).
- Assigned to international characters in various versions

## SUMMARY OF CHARACTER CODES

|                      |   |                           |
|----------------------|---|---------------------------|
| Morse                | = | Dot (.) and Dash (-)      |
| Baudot               | = | 5 bit (no parity)         |
| International Baudot | = | 6 bit (5 data + 1 parity) |
| ASCII                | = | 8 bit (7 data + 1 parity) |
| EBCDIC               | = | 9 bit (8 data + 1 parity) |

### Error Control

Networks must be able to transfer data from one device to another with complete accuracy. Data can be corrupted during transmission. For reliable communication, errors must be detected and corrected. Error control can be divided into two general categories:

[1]. Error Detection

[2]. Error Correction

Error detection and Error correction are implemented either at the data link layer or the transport layer of the OSI model.

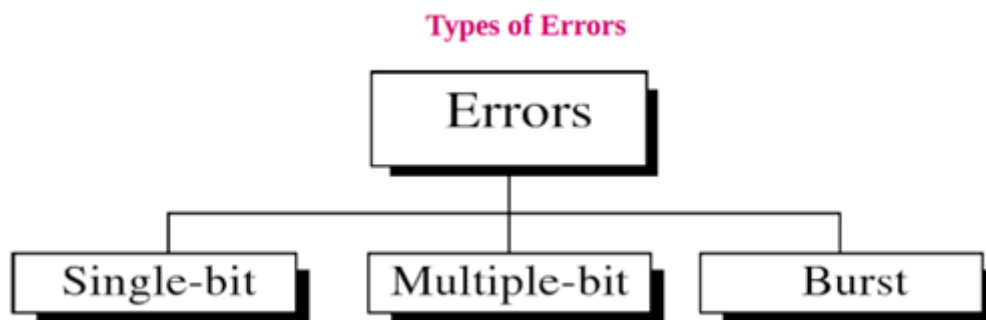

[1]. Single Bit Error

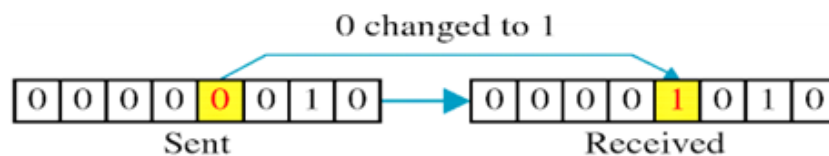

Single bit errors are the least likely type of errors in serial data transmission because the noise must have a very short duration which is very rare. However this kind of errors can happen in parallel transmission.

[2]. Multiple Bit Error

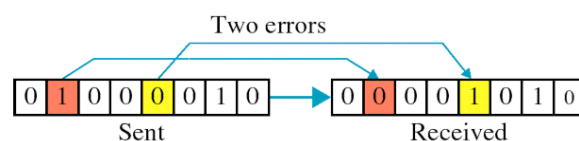

### [3]. burst error

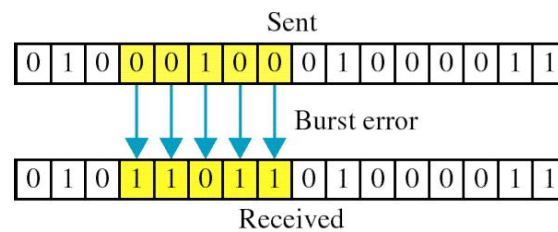

- The term burst error means that two or more bits in the data unit have changed from 1 to 0 or from 0 to 1.
- Burst errors does not necessarily mean that the errors occur in consecutive bits, the length of the burst is measured from the first corrupted bit to the last corrupted bit. Some bits in between may not have been corrupted.
- Burst error is most likely to happen in serial transmission since the duration of noise is normally longer than the duration of a bit. The number of bits affected depends on the data rate and duration of noise.

### Error detection

Error detection means to decide whether the received data is correct or not without having a copy of the original message.

Error detection uses the concept of redundancy, which means adding extra bits for detecting errors at the destination.

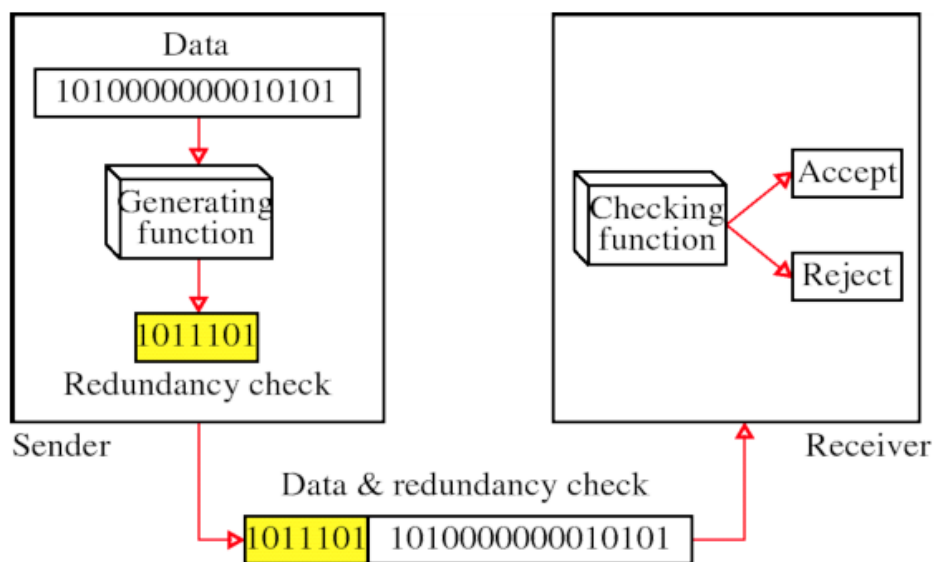
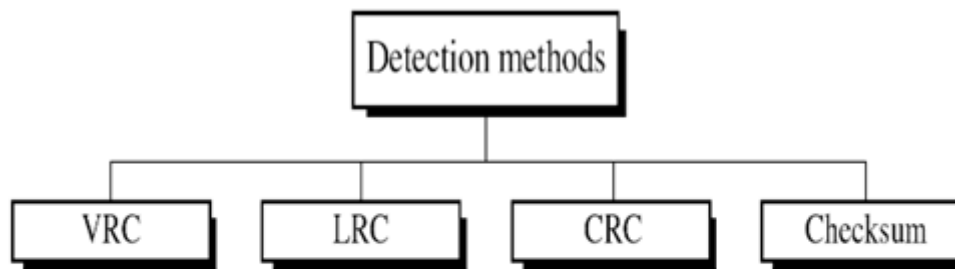

Fig. Redundancy

## Redundancy Check Types:



- (1). VRC - Vertical Redundancy Check
- (2). LRC - Longitudinal Redundancy Check
- (3). CRC - Cyclic Redundancy Check
- (4). Checksum

### Vertical Redundancy Check (VRC)

VRC is also referred to as character parity. With character parity, each character has its own error-detection bit called the parity bit. The parity bit is considered as a redundant bit. An n-character message would have 'n' redundant parity bits.

- It can detect single bit error.
- It can detect burst errors only if the total number of errors is odd.

### Longitudinal Redundancy Check (LRC)

LRC is also referred to as message parity since it is used to check error occurred within a message. With LRC each bit position has a parity bit. LRC is the result of XORing the bits present in all the characters present in a message whereas VRC is the result of XORing the bits within a single character.

- In LRC even parity is generally used, whereas with VRC odd parity is generally used.
- LCR increases the likelihood of detecting burst errors.
- If two bits in one data units are damaged and two bits in exactly the same positions in another data unit are also damaged, the LRC checker will not detect an error.

### Checksum

The characters within a message are combined together to produce an error-checking character called as checksum, which can be as simple as the arithmetic sum of the numerical values of all the characters in the message. The checksum is appended to the end of the message.

The receiver replicates the combining operation and determines its own checksum. The receiver's checksum is compared with transmitter checksum appended with the message, and if they are the same, it is assumed that no transmission errors have occurred.

### Cyclic Redundancy Check (CRC)

It's a most reliable redundancy checking technique for error detection is a convolutional coding scheme called Cyclic Redundancy Check(CRC). Given a k-bit frame or message, the transmitter generates an (n-k) bit sequence, known as a frame check sequence (FCS)(or) Block Check Code(BCS), so that the resulting frame, consisting of 'n' bits, is exactly divisible by some predetermined number. The receiver then divides the incoming frame by the same number and, if there is no remainder, assumes that there was no error.

### **Modulator- Demodulator (MODEM)**

Modems are used for data transfer from one computer network to another computer network through telephone lines. The computer network works in digital mode, while analog technology is used for carrying messages across phone lines. The device which performs modulation is called a modulator and the device which recovers the information signal from the modulated carrier is called a demodulator. In data transmission, we usually come across devices which perform both modulation as well as demodulation functions and these devices are called modems.

When data is to be transmitted over long distances, modems are needed. In a modem, the input signal modulates a carrier which is transmitted to the distant end. At the distant end, another modem demodulates the received carrier to obtain the digital signal. Thus, a pair of modems is always required. The term 'modem' is derived from the words, Modulator and Demodulator.

Modulator converts information from digital mode to analog mode at the transmitting end and demodulator converts the same from analog to digital at receiving end. The process of converting analog signals of one computer network into digital signals of another computer network so they can be processed by a receiving computer is referred to as digitizing. A modem contains a modulator as well as a demodulator.

Nearly all the modems are designed for utilizing the analog voice band service provided by the telecommunication network. Thus, the modulated carrier produced by a modem fits into the 300-400 Hz bandwidth of the speech channel. The figure shows a typical data connection set up using modems. The digital terminal devices exchange digital signals and are known as Data Terminal Equipment (DTE). Two modems are always needed, one at each end. At the transmitting end, the modem converts the digital signal from the DTE into an analog signal by modulating a carrier. At the receiving end, the modem demodulates the carrier and hands over the demodulated digital signal to the DTE.

A dedicated leased circuit or a switched telephone circuit can be used as transmission medium between the two modems. In the latter case, modems are connected to the local telephone exchanges. Whenever data transmission is needed, connection between the modems is established through the telephone exchanges. Modems are also needed within a building to connect terminals which are located at distances, more than 15 metres from the host.

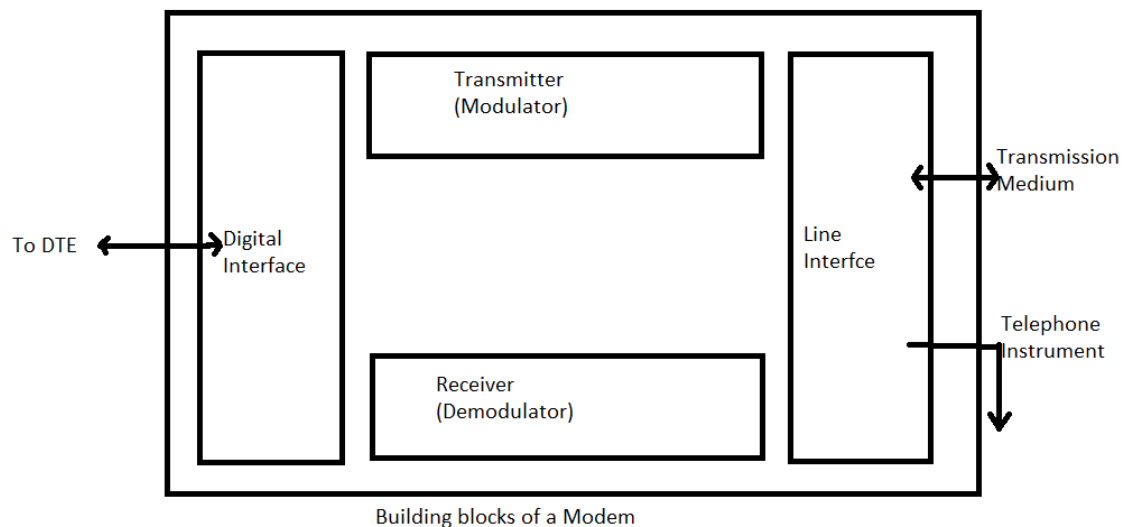

A block diagram of a modem is shown in the above figure, which comprises a transmitter, a receiver and two interfaces. The digital signal to be sent is given to the transmitter. The modulated carrier that is received from the distant end is given to the receiver. The digital interface connects the modem to the DTE which produces and receives the digital signals. In order to transmit it and receive the modulated signals, the line interface connects the modem to the transmission channel. Modems connected to telephone exchanges have additional provision for connecting a telephone instrument, which enables establishment of the telephone connection.

The transmission medium between the two modems can be a dedicated circuit or a switched telephone circuit. If a switched telephone circuit is used, then the modems are connected to the local telephone exchanges. Whenever data transmission is required connection between the modems is established through telephone exchanges.



# WIRELESS COMMUNICATION

## **Introduction**

In the older mobile radio systems, single high power transmitter was used to provide coverage in the entire area. Although this technique provided a good coverage, but it was virtually impossible in this technique to re-use the same radio channels in the system, and any effort to re-use the radio channels would result in interference. Therefore, in order to improve the performance of a wireless system with the rise in the demand for the services, a cellular concept was later proposed. This chapter will examine several parameters related with the cellular concept.

## **The Cellular Concept**

The design aim of early mobile wireless communication systems was to get a huge coverage area with a single, high-power transmitter and an antenna installed on a giant tower, transmitting a data on a single frequency. Although this method accomplished a good coverage, but it also means that it was practically not possible to reuse the same frequency all over the system, because any effort to reuse the same frequency would result in interference. The cellular concept was a major breakthrough in order to solve the problems of limited user capacity and spectral congestion. Cellular system provides high capacity with a limited frequency spectrum without making any major technological changes. It is a system-level idea in which a single high-power transmitter is replaced with multiple low- power transmitters, and small segment of the service area is being covered by each transmitter, which is referred to as a cell. Each base station (transmitter) is allocated a part of the total number of channels present in the whole system, and different groups of radio channels are allocated to the neighboring base stations so that all the channels present in the system are allocated to a moderately small number of neighboring base stations.

The mobile transceivers (also called mobile phones, handsets, mobile terminals or mobile stations) exchange radio signals with any number of base stations. Mobile phones are not linked to a specific base station, but can utilize any one of the base stations put up by the company. Multiple base stations covers the entire region in such a way that the user can move around and phone call can be carried on without interruption, possibly using more than one base station. The procedure of changing a base station at cell boundaries is called *handover*. Communication from the Mobile Station (MS) or mobile phones to the Base Station (BS) happens on an uplink channel also called reverse link, and downlink channel or forward link is used for communication from BS to MS. To maintain a bidirectional communication

between a MS and BS, transmission resources must be offered in both the uplink and downlink directions. This can take place either using Frequency-Division Duplex (FDD), in which separate frequencies are used for both uplink and downlink channels, or through Time-Division Duplex (TDD), where uplink and downlink communications take place on the same frequency, but vary in time.

FDD is the most efficient technique if traffic is symmetric, and FDD has also made the task of radio planning more efficient and easier, because no interference takes place between base stations as they transmit and receive data on different frequencies. In case of an asymmetry in the uplink and downlink data speed, the TDD performs better than FDD. As the uplink data rate increases, extra bandwidth is dynamically allocated to that, and as the data rate decreases, the allotted bandwidth is taken away.

Some of the important cellular concepts are:

- Frequency reuse
- Channel Allocation
- Handoff
- Interference and system capacity
- Trunking and grade of service
- Improving coverage and capacity

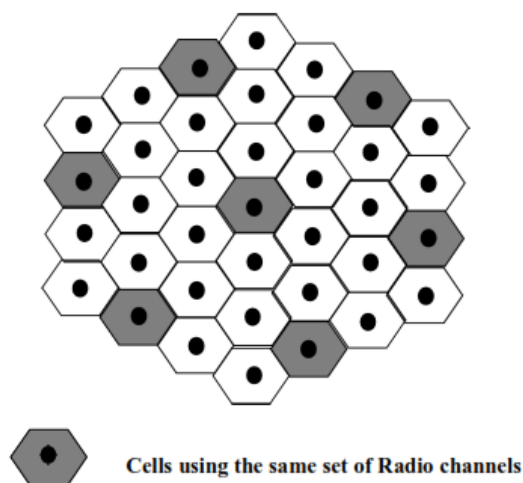

Figure 1. Cellular Network with Rrequency Reuse

### Frequency reuse

Conventional communication systems faced the problems of limited service area capability and ineffective radio spectrum utilization. This is because these systems are generally designed to provide service in an autonomous geographic region and by selecting radio channels from a particular frequency band. On the other hand, the present mobile

communication systems are designed to offer a wide coverage area and high grade of service. These systems are also expected to provide a continuous communication through an efficient utilization of available radio spectrum. Therefore, the design of mobile radio network must satisfy the following objectives i.e., providing continuous service, and wide service area, while efficiently using the radio spectrum.

In order to achieve these objectives, the present mobile systems use cellular networks which depend more on an intelligent channel allocation and reuse of channels throughout the region. Each base station is allocated a set of radio channels, which are to be used in a geographic area called a *cell*. Base stations in the neighboring cells are allocated radio channel sets, which are entirely different. The antennas of base station antennas are designed to get the required coverage within the specific cell. By restricting the coverage area of a base station to within the cell boundaries, the same set of radio channels can be used in the different cells that are separated from each other by distances which are large enough in order to maintain interference levels within limits. The procedure of radio sets selection and allocation to all the base stations present within a network is called *frequency reuse* .

Fig. 1 shows the frequency reuse concept in a cell in a cellular network, in which cells utilize the same set of radio channels. The frequency reuse plan indicates where different radio channels are used. The hexagonal shape of cell is purely theoretical and is a simple model of radio coverage for each base station, although it has been globally adopted as the hexagon permits the easy analysis of a cellular system. As hexagon covers the largest area from the center of a polygon to its farthest point, therefore, hexagon geometry can cover the entire geographic region to the fullest with minimum number of cells. When hexagon geometry is used to cover the entire geographic area, the base stations are either put up at the center of the cell, these cells are also called center excited cells or at the three of the six vertices (edge excited cells).

Generally, center excited cells use omni-directional antennas and corner excited cells use directional antennas, but practically considerations for placing base stations are not exactly the same as they are shown in the hexagonal layouts.

### **Channel Reuse Schemes**

The radio channel reuse model can be used in the time and space domain. Channel reuse in the time domain turns out to be occupation of same frequency in different time slots and is also called Time Division Multiplexing.

Channel reuse in the space domain is categorized into:

- a) Same channel is allocated in two different areas, e.g. AM and FM radio stations using same channels in two different cities.
- b) Same channel is frequently used in same area and in one system the scheme used is cellular systems. The entire spectrum is then divided into  $K$  reuse sets.

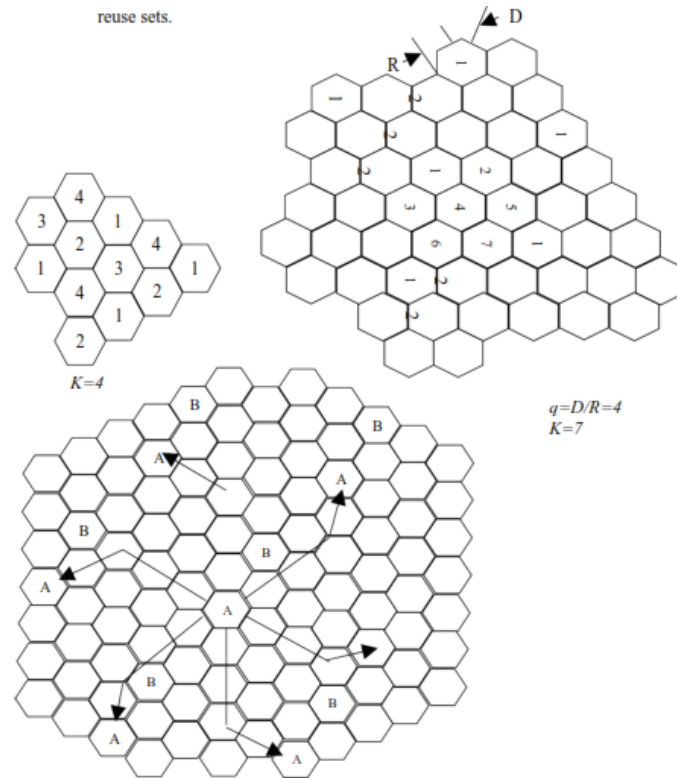

K-CELL REUSE PATTERN

### Channel Allocation Schemes

For effective utilization of the radio spectrum, a channel reuse scheme is required which must be able to increase the capacity and reduce interference. Several channel allocation schemes have been proposed to address these objectives. Channel allocation schemes are classified into *fixed*, *dynamic*, and *hybrid*. The selection of a particular channel allocation scheme influences the performance of the system, mainly how to manage the calls when a call is handed-over from one cell to another.

In a fixed channel allocation scheme, a set of nominal channels are permanently allocated to each cell. Any call generated from within the cell can only be served by the idle radio Channels present in that cell. If all the radio channels present in that cell are occupied, then the call is *blocked*. However, there exist a several variations of the fixed allocation. In one of the variation, a cell can borrow channels from neighboring cells if its own channels are already busy, and this scheme is called channel borrowing strategy. Such a borrowing

procedure is being managed by mobile switching center (MSC) and it try to make sure that the borrowing of a radio channel form neighboring cells does not interfere with any of the existing calls present in the donor cell.

In a dynamic channel allocation scheme, cells are not allocated radio channels permanently. Instead, every time when a call is received, the serving base station (BS) enquires a channel from the MSC. The MSC allocates a channel to the cell after taking into consideration the possibility of future blocking rate of the candidate cell, the re-use distance of the channel, and several other parameters.

Therefore, the MSC then allocates a particular channel if that radio channel is currently not in use in the candidate cell as well in any other neighboring cell which falls inside the minimum channel reuse distance in order to avoid co-channel interference. The Dynamic channel allocation minimizes the possibility of blocking, thereby increasing the trunking capacity of the system, as all the available channels are accessible to all the cells. In Dynamic channel allocation schemes MSC gather information on traffic distribution, channel occupancy of all channels on a regular basis. This results in increased channel utilization with decreased probability of dropped and blocked calls, but at the same time the computational load on the system also increases.

### **Handoff Strategies**

When a mobile moves from one cell to another cell when a call is in progress, the MSC automatically shifts the call to a new channel present in the new cell. This handoff operation requires the identification of a new base station, and channels that are associated with the new base station.

In any cellular network, managing handoff is very important job. Many handoff schemes give high priority to handover requests over new call requests while allocating free channels, and it must be performed successfully and as infrequently as possible.

Therefore, in order to satisfy these requirements, optimum signal at which to begin a handoff level must be specified by system designers. When an optimal signal level for acceptable voice quality is specified, a somewhat stronger signal level is used as a threshold at which a handoff is made. This margin is given by  $A = Pr_{handoff} - Pr_{minimum\_usable}$  and it should not be too large or too small. If A is very large, needless handoffs which can burden the MSC may take place, and if A is very small, there may not be a sufficient time to complete a handoff process, before a call is vanished due to weak signal. Therefore, A should be carefully selected to meet these contradictory requirements.

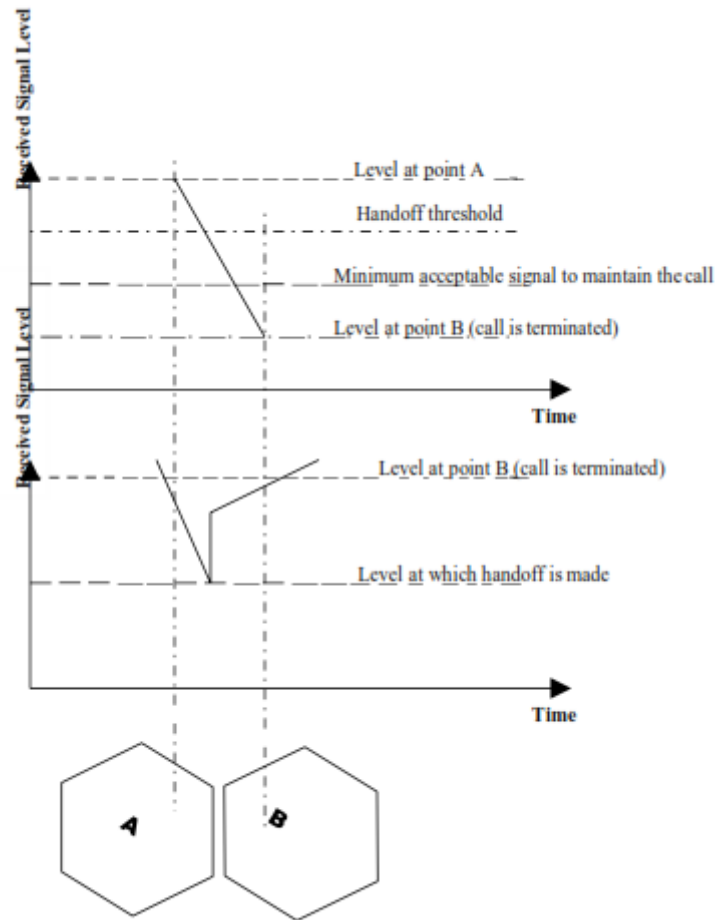

Fig. 1.11: Handoff Situation

Fig. above shows a handoff situation. It presents a case in which a handoff does not take place and the signal strength falls below the minimum acceptable level in order to keep the channel active. This call dropping occurs when there is tremendous delay by the MSC in allocating a handoff, or when the threshold A is too small. During high traffic loads unnecessary delays may take place and this happens either due to computational overloading at the MSC or no free channels are available in any of the neighboring cells and thereby MSC has to wait until a free channel is found in a neighboring cell.

While deciding about handoff initiation time, it is important to make sure that the drop in the signal level is not due to temporary fading but the mobile is in fact moving away from its base station. Therefore, base station observes the signal strength for a definite period of time before a handoff begins. This signal strength measurement must be optimized in order to avoid unwanted handoffs, while ensuring that unwanted handoffs are completed before a call gets dropped. The time required to come to a decision if a handoff is needed, depends on the speed of the vehicle at which it is moving. Information about the speed of vehicle can also be calculated from the fading signal received at the base station.

The time during which a caller remains within a cell, without any handoff to the neighboring cells, is called the *dwell time*. The dwell time of a call depends upon a number of factors i.e. propagation, interference, distance between the caller and the base station, and several other time varying factors. It has been analyzed that variation of dwell time depends on the speed of the caller and the radio coverage type. e.g., a cell in which radio coverage is provided to highway callers (using vehicles), a large number of callers have a moderately steady speed and they follow fixed paths with good radio coverage. For such instances, the dwell time for random caller is a random variable having distribution that is highly concentrated on the mean dwell time. Whereas, for callers present in dense, micro-cellular environments, there is normally a huge deviation of dwell time about the mean, and the dwell times in general are shorter than the cell geometry. It is clear that the information of dwell time is very important while designing handoff algorithms.

In first generation cellular systems, signal strength computations are done by the base stations and monitored by the MSC. All the base stations regularly observe the signal strengths of its reverse channels to find out the relative location of each mobile user with respect to the base station. In addition to calculating the radio signal strength indication (RSSI) of ongoing calls in the cell, an extra receiver in each base station, is used to find out signal strengths of mobile users present in the neighboring cells. The extra receiver is controlled by the MSC and is used to examine the signal strength of callers in the neighboring cells, and informs RSSI to the MSC. Based on the RSSI values received from each extra receiver, the MSC determines whether handoff is required or not.

In second generation cellular systems using digital TDMA technology, handoff decisions are *mobile assisted*. In *mobile assisted handoff (MAHO)*, each mobile station measures the received power from the neighboring base stations and informs these results to the serving base station. A handoff starts when the power received from the base station of a neighboring cell go above the power received from the present base station. In MAHO scheme, the call to be handed off between different base stations at a lot faster speed than in first generation systems because the handoff computations are done by each mobile and by keeping the MSC out of these computations. MAHO is suitable for micro-cellular network architectures where handoffs are more frequent.

When a call is in progress, if a mobile shifts from one cellular system to an another cellular system managed by a different MSC, an *intersystem handoff* is required. An MSC performs an intersystem handoff when a signal goes weak in a particular cell and the MSC fails to find another cell inside its system to which it can move the ongoing call, and several

issues should be addressed while intersystem handoff is implemented. e.g. a local call might automatically turn into a long-distance call when the caller shifts out of its home network and enters into a neighboring system.

Various systems have different methods for dealing with hand-off requests. Several systems manage handoff requests in the same way as they manage new call requests. In such systems, the possibility that a handoff call will not be served by a new base station is equivalent to the blocking probability of new calls. However, if a call is terminated unexpectedly while in progress is more frustrating than being blocked occasionally on a new call. Therefore, to improve the quality of service, various methods have been created to give priority to handoff call requests over new call requests while allocating channels.

### **Prioritizing Handoffs**

One scheme for prioritizing handoffs call requests is called the *guard channel concept*, in which a part of the existing channels in a cell is reserved entirely for handoff call requests. The major drawback of this scheme is that it reduces the total carried traffic, as smaller number of channels is allocated to new calls. However, guard channels scheme present efficient spectrum utilization when dynamic channel allocation strategies are used.

Queuing of handoff calls is another way to minimize the forced call terminations due to unavailability of channels in the cell. There is actually a tradeoff between the minimization in the possibility of forced call termination of handoff calls and total carried traffic. Handoff call queuing is possible as there is a fixed time interval between the time the received signal strength falls below the handoff threshold and the time the call is terminated due to unavailability of signal strength. The queue size and delay time is calculated from the traffic pattern of the service area. It should be noted that queuing of handoff calls does not promise a zero forced call terminations, because large delays will force the received signal strength to fall below the minimum level required to maintain communication and therefore, lead to forced handoff call termination.

### **Co-channel Interference and System Capacity**

The channel reuse approach is very useful for increasing the efficiency of radio spectrum utilization but it results in co-channel interference because the same radio channel is repeatedly used in different co-channel cells in a network. In this case, the quality of a received signal is very much affected both by the amount of radio coverage area and the co-channel interference.

Co-channel interference takes place when two or more transmitters located within a wireless system, or even a neighboring wireless system, which are transmitting on the same



radio channel. Co-channel interference happens when the same carrier frequency (base station) reaches the same receiver (mobile phone) from two different transmitters.

This type of interference is generally generated because channel sets have been allocated to two different cells that are not far enough geographically, and their signals are strong enough to cause interference to each other. Thus, co-channel interference can either modify the receiver or mask the particular signal. It may also merge with the particular signal to cause severe distortions in the output signal.

The performance of interference-limited cellular mobile system can be calculated from the following results.

- a) If the signal-to-interference ratio (S/I) is greater than 18 dB, then the system is said to be correctly designed.
- b) If S/I is less than 18 dB and signal-to-noise ratio (S/N) is greater than 18 dB, then the system is said to be experiencing with a co-channel interference problem.
- c) If both S/I and S/N are less than 18 dB and S/I is approximately same as S/N in a cell, then the system has a radio coverage problem.
- d) If both S/I and S/N are less than 18 dB and S/I is less than S/N, the system has both co-channel interference and radio coverage problem.

The co-channel interference can be reduced by the following methods:

*a. Increasing the distance(D) between two co-channel cells.*

As D increases, the strength of interfering signal from co-channel interfering cells decreases significantly. But it is not wise to increase D because as D is increased, K must also be increased. High value of K means fewer number of radio channels are available per cell for a given spectrum. This results into decrease of the system capacity in terms of channels that are available per cell.

*b. Reducing the antenna heights*

Reducing antenna height is a good method to minimize the co-channel interference in some environment, e.g., on a high hill. In the cellular system design effective antenna height is considered rather than the actual antenna height.

Therefore, the effective antenna height changes according to the present location of the mobile unit in such a difficult terrain.

When the antenna is put up on top of the hill, the effective antenna height gets more than the actual antenna height. So, in order to minimize the co-channel interference, antenna with lower height should be used without decreasing the received signal strength either at the cell-site or at the mobile device. Similarly, lower antenna height in a valley is very useful in

minimizing the radiated power in a far-off high-elevation area where the mobile user is believed to be present.

However, reducing the antenna height does not always minimize the co-channel interference, e.g., in forests, the larger antenna height clears the tops of the longest trees in the surrounding area, particularly when they are located very close to the antenna. But reducing the antenna height would not be appropriate for minimizing co-channel interference because unnecessary attenuation of the signal would occur in the vicinity of the antenna as well as in the cell boundary if the height of the antenna is below the treetop level.

*c. Using directional antennas.*

The use of directional antennas in every cell can minimize the co-channel interference if the co-channel interference cannot be avoided by a fixed division of co-channel cells. This will also improve the system capacity even if the traffic increases. The co-channel interference can be further minimized by smartly setting up the directional antenna.

*d. Use of diversity schemes at the receiver.*

The diversity scheme used at the receiving end of the antenna is an efficient technique for minimizing the co-channel interference because any unwanted action performed at the receiving end to increase the signal interference would not cause further interference. For example, the division of two receiving antennas installed at the cell-site meeting the condition of  $h/s=11$ , (where  $h$  is the antenna height and  $s$  is the division between two antennas), would produce the correlation coefficient of 0.7 for a two-branch diversity system. The two correlated signals can be combined with the use of selective combiner. The mobile transmitter could suffer up to 7 dB minimization in power and the same performance at the cell-site can be achieved as a non-diversity receiver. Therefore, interference from the mobile transmitters to the receivers can be significantly reduced.

### **Adjacent Channel Interference**

Signals from neighboring radio channels, also called adjacent channel, leak into the particular channel, thus causing adjacent channel interference. Adjacent channel interference takes place due to the inability of a mobile phone to separate out the signals of adjacent channels allocated to neighboring cell sites (e.g., channel 101 in cell A, and channel 102 in cell B), where both A and D cells are present in the same reuse cluster.

The problem of adjacent channel interference can become more serious if a user transmitting on a channel, which is extremely close to a subscriber's receiver channel, while the receiver tries to receive a signal from base station on the desired channel. This is called the *near and far* effect, where a neighboring transmitter catches the receiver of the user.

Otherwise, the near-far effect occurs when a mobile near to a base station transmits on a channel which is close to the one being used by a weak mobile. The base station may find some trouble in separating out a particular user from the one using adjacent channel.

Adjacent channel interference can be reduced through careful and thorough filtering and efficient channel allocations. As each cell is allocated only a portion of the total channels, a cell must not be allocated channels which are located adjacent in frequency. By maintaining the channel separation as large as possible in a given cell, the adjacent channel interference may well be minimized significantly. Hence, instead of allocating contiguous band of channels to each cell, channels are allocated such a way that the frequency separation between channels in a given cell should be maximized. With sequentially allocating consecutive channels to various cells, several channel allocation schemes are capable enough to keep apart adjacent channels present in a cell with bandwidth of  $N$  channels, where  $N$  is the size of a cluster. However, some channel allocation schemes also avoid a secondary source of adjacent channel interference by not using the adjacent channels in neighboring cells.

### **Trunking and Grade of Service**

In cellular mobile communication, the two major aspects that have to be considered with extra care are: trunking, and grade of service. These aspects are to be planned very well in order to get a better system performance. The grade of service is a standard which is used to define the performance of a cellular mobile communication system by specifying a desired probability of a mobile user acquiring channel access, when a definite number of radio channels are present in the system. The cellular communication network depends on a trunking system to fit large number of mobile users in a limited radio band. The statistical behavior of mobile users is being exploited by trunking so that a fixed number of channels can be allocated to large mobile users. In trunking, large number of mobile users is being accommodated to share the limited radio channels available in a cell.

In trunked cellular communication systems, each mobile user present in network is allocated a channel on the basis of a request. After the call is terminated, the occupied channels immediately go back to the pool of available channels. When a mobile user made a request for channels and if all of the radio channels are occupied, then the incoming call is blocked. In few communication systems, a queue is generally used to keep the requesting mobile users until a channel becomes free. The grade of service (GOS) is used to determine the capability of a user to get access to trunked radio systems during busy hours. The busy hour is generally based on customer's request for channels during peak load.

It is, therefore, necessary to approximate the maximum required capacity in terms of number of available channels and to allocate the appropriate number of channels in order to meet the GOS. GOS is generally defined as the probability that a call is blocked. A call which cannot get completed after the call request is made by a user is called a blocked or lost call, and it may happen either due to channel congestion or due to the non availability of a free channel. Therefore, GOS can be computed from channel congestion which is defined as the call blocking probability, or being delayed beyond a certain time.

### **Improving Capacity In Cellular Systems**

With the rise in the demand for wireless services, the number of radio channels allocated to each cell could become inadequate in order to satisfy this increase in the demand. Therefore, to increase the capacity (i.e. a cellular system can take up more calls) of a cellular system, it is very important to allocate more number of radio channels to each cell in order to meet the requirements of mobile traffic. Various techniques that are proposed for increasing the capacity of a cellular system is as follows:

- i. Cell splitting
- ii. Cell sectoring
- iii. Micro zone method

### **Cell Splitting**

Cell splitting is a method in which congested (heavy traffic) cell is subdivided into smaller cells, and each smaller cell is having its own base station with reduction in antenna height and transmitter power. The original congested bigger cell is called macrocell and the smaller cells are called microcells. Capacity of cellular network can be increased by creating micro-cells within the original cells which are having smaller radius than macro-cells, therefore, the capacity of a system increases because more channels per unit area are now available in a network.

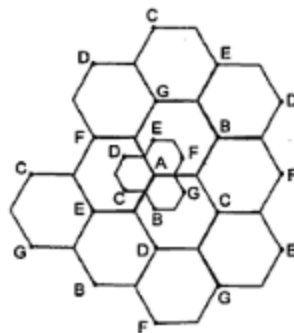

Fig. shows a cell splitting in which a congested cell, divided into smaller micro cells, and the base stations are put up at corners of the cells. The micro-cells are to be added in such a way

in order to the frequency reuse plan of the system should be preserved. For micro-cells, the transmit power of transmitter should be reduced, and each micro-cell is having half the radius to that of macro-cell. Therefore, transmit power of the new cells can be calculated by analyzing the received power at the cell boundaries. This is required in order to make sure that frequency reuse plan for the micro-cells is also working the same way as it was working for the macro-cells. In cell splitting, following factors should be carefully monitored;

1. In cell splitting, allocation of channels to the new cells (micro-cells) must be done very cautiously. So, in order to avoid co-channel interference, cells must follow the minimum reuse distance principle.

2. Power levels of the transmitters for new and old cells must be redesigned. If the transmitter of the old cell has the same power as that of new cells, then the channels in old cell interfere with the channels of new cell. But, if the power level of transmitter is too low then it may result into insufficient area coverage.

3. In order to overcome the problem of point (2); the channels of macro cell is divided into two parts. The channels in the first part are for the new cell and other part consists of channel for the old cell. Splitting of cells is done according to the number of subscribers present in the areas, and the power levels of the transmitters must be redesigned according to the allocated channels to old and new cells.

4. Antennas of different heights and power levels are used for smooth and easy handoff, and this technique is called Umbrella cell approach. Using this approach large coverage area is provided for high speed users and small coverage area to low speed users. Therefore, the number of call handoffs is maximized for high speed users and provides more channels for slow speed users.

5. The main idea behind cell splitting is the rescaling of entire system. In cell splitting, reuse factor ( $D/R$ ) is kept constant because by decreasing the radius of cell ( $R$ ) and, at the same time, the separation between co-channel ( $D$ ) is also decreased. So, high capacity can be achieved without changing the ( $D/R$ ) ratio of system.

### **Sectoring**

Another way of improving the channel capacity of a cellular system is to decrease the  $D/R$  ratio while keeping the same cell radius. Improvement in the capacity can be accomplished by reducing the number of cells in a cluster, hence increasing the frequency reuse. To achieve this, the relative interference must be minimized without decreasing the transmit power.

For minimizing co-channel interference in a cellular network, a single omnidirectional antenna is replaced with multiple directional antennas, with each transmitting within a smaller region. These smaller regions are called sectors and minimizing co-channel interference while improving the capacity of a system by using multiple directional antennas is called sectoring. The amount up to which co-channel interference is minimized depends on the amount of sectoring used. A cell is generally divided either into three 120 degree or six 60 degree sectors. In the three-sector arrangement, three antennas are generally located in each sector with one transmit and two receive antennas.

The placement of two receive antennas provide antenna diversity, which is also known as space diversity. Space diversity greatly improves the reception of a signal by efficiently providing a big target for signals transmitted from mobile units. The division between the two receive antenna depends on the height of the antennas above ground.

When sectoring technique is used in cellular systems, the channels used in a particular sector are actually broken down into sectored groups, which are only used inside a particular sector. With 7-cell reuse pattern and 120 degree sectors, the number of interfering cells in the neighboring tier is brought down from six to two. Cell sectoring also improves the signal-to-interference ratio, thereby increasing the capacity of a cellular system. This method of cell sectoring is very efficient, because it utilized the existing system structures. Cell sectoring also minimized the co-channel interference, with the use of directional antennas, a particular cell will get interference and transmit only a fraction of the available co-channel cells.

### **Microcell Zone Concept**

The micro-cell zone concept is associated with sharing the same radio equipment by different micro-cells. It results in decreasing of cluster size and, therefore, increase in system capacity. The micro-cell zone concept is used in practice to improve the capacity of cellular systems.

To improve both capacity and signal quality of a cellular system, cell sectoring depends upon correct setting up of directional antennas at the cell-site. But it also gives rise to increase in the number of handoffs and trunking inefficiencies. In a 3-sector or 6-sector cellular system, each sector acts like a new cell with a different shape and cell. Channels allocated to the un-sectored cell are divided between the different sectors present in a cell, thereby decreasing number of channels available in each sector. Furthermore, handoff takes place every time a mobile user moves from one sector to another sector of the same cell. This results in significant increase of network load on BSC and MSC of the cellular system. The

problem of channel partitioning and increase in network load become very hard if all the 3 or 6-sectored directional antennas are placed at the centre of the cell.

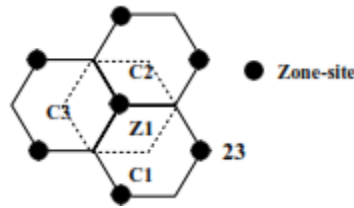

As shown in the Fig, three directional antennas are put at a point, Z1, also called zone-site, where three adjacent cells C1, C2, and C3 meet with each other. Z1, Z2 and Z3 are three zone-sites of the cell C1, and each zone-site is using three 135 degree directional antennas. All the three zone-sites also behave as receivers, which also receive signals transmitted by a mobile user present anywhere in the cell.

In order to avoid delay, these zone-sites are connected through a high-speed fiber link to the base station. The base station first finds out, which of the three zone-sites has the better received signal strength from the mobile user and then that particular zone-site is used to transmit the signal to the mobile user. Therefore, only one zone-site is active at a time for communicating with the user and it also minimizes the co-channel interference experienced by the mobile user.

### IEEE Wireless Standards

- Wireless networks are standardized by IEEE.
- Under 802 LAN MAN standards committee.

The 802.11 standard is defined through several specifications of WLANs. It defines an over-the-air interface between a wireless client and a base station or between two wireless clients.

### There are several specifications in the 802.11 family -

- 802.11** - This pertains to wireless LANs and provides 1 - or 2-Mbps transmission in the 2.4-GHz band using either frequency-hopping spread spectrum (FHSS) or direct-sequence spread spectrum (DSSS).
- 802.11a** - This is an extension to 802.11 that pertains to wireless LANs and goes as fast as 54 Mbps in the 5-GHz band. 802.11a employs the orthogonal frequency division multiplexing (OFDM) encoding scheme as opposed to either FHSS or DSSS.
- 802.11b** - The 802.11 high rate WiFi is an extension to 802.11 that pertains to wireless LANs and yields a connection as fast as 11 Mbps transmission (with a fallback to 5.5, 2, and 1 Mbps depending on strength of signal) in the 2.4-GHz band. The 802.11b specification uses only DSSS. Note that 802.11b was actually an amendment to the original 802.11 standard

added in 1999 to permit wireless functionality to be analogous to hardwired Ethernet connections.

- **802.11g** - This pertains to wireless LANs and provides 20+ Mbps in the 2.4-GHz band.
- **802.11n** — 802.11n builds upon previous 802.11 standards by adding *multiple input multiple-output* (MIMO). The additional transmitter and receiver antennas allow for increased data throughput through spatial multiplexing and increased range by exploiting the spatial diversity through coding schemes like Alamouti coding. The real speed would be 100 Mbit/s (even 250 Mbit/s in PHY level), and so up to 4-5 times faster than 802.11g.
- **802.11ac** — 802.11ac builds upon previous 802.11 standards, particularly the 802.11n standard, to deliver data rates of 433Mbps per spatial stream, or 1.3Gbps in a three antenna (three stream) design. The 802.11ac specification operates only in the 5 GHz frequency range and features support for wider channels (80MHz and 160MHz) and beam forming capabilities by default to help achieve its higher wireless speeds.

### **GSM:-**

GSM stands for **G**lobal **S**ystem for **M**obile **C**ommunication. It is a digital cellular technology used for transmitting mobile voice and data services. Important facts about the GSM are given below:

- The concept of GSM emerged from a cell-based mobile radio system at Bell Laboratories in the early 1970s.
- GSM is the name of a standardization group established in 1982 to create a common European mobile telephone standard.
- GSM is the most widely accepted standard in telecommunications and it is implemented globally.
- GSM is a circuit-switched system that divides each 200 kHz channel into eight 25 kHz time-slots. GSM operates on the mobile communication bands 900 MHz and 1800 MHz in most parts of the world. In the US, GSM operates in the bands 850 MHz and 1900 MHz.
- GSM owns a market share of more than 70% of the world's digital cellular subscribers.
- GSM makes use of narrowband Time Division Multiple Access (TDMA) technique for transmitting signals.
- GSM was developed using digital technology. It has an ability to carry 64 kbps to 120 Mbps of data rates.
- Presently GSM supports more than one billion mobile subscribers in more than 190 countries throughout the world.



- GSM provides basic to advanced voice and data services including roaming service. Roaming is the ability to use your GSM phone number in another GSM network.

GSM digitizes and compresses data, then sends it down through a channel with two other streams of user data, each in its own timeslot.

Listed below are the features of GSM that account for its popularity and wide acceptance.

- Improved spectrum efficiency
- International roaming
- Low-cost mobile sets and base stations (BSs)
- High-quality speech
- Compatibility with Integrated Services Digital Network (ISDN) and other telephone company services
- Support for new services

### GSM: System Architecture

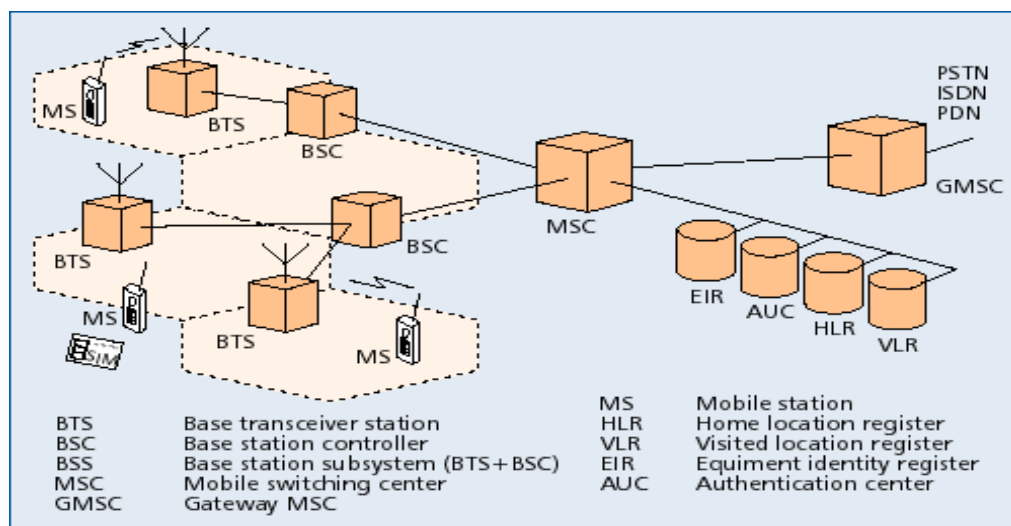

A GSM network comprises of many functional units. These functions and interfaces are explained in this chapter. The GSM network can be broadly divided into:

- The Mobile Station (MS)
- The Base Station Subsystem (BSS)
- The Network Switching Subsystem (NSS)
- The Operation Support Subsystem (OSS)

### Mobile Station (MS)

MS consists of following two components

- Mobile Equipment (ME)
- *Mobile* Subscriber Identity Module (SIM)

It allows separation of user mobility from equipment mobility.

### **Base Transceiver Station (BTS)**

It is placed one per cell. It consists of high speed transmitter and receiver. The Function of BTS are:

- Provides two channels
  - Signalling and Data Channel
- Performs error protection coding for the radio channel.

### **Base Station Controller (BSC)**

It controls multiple BTS. The main functions of BSC are:

- It performs radio resource management.
  - Assigns and releases frequencies and time slots for all the MSs in its area.
  - Reallocation of frequencies among cells.
  - Hand off protocol is executed here.
- Time and frequency synchronization signals to BTSs.
- Time Delay Measurement and notification of an MS to BTS.
- Power Management of BTS and MS.

### **Mobile Switching Center (MSC)**

- It is the switching node of a PLMN (Public Land Mobile Network). There can be several MSCs in a PLMN. Its main functions are:
  - Allocation of radio resource (RR) and Hand off.
  - Mobility of subscribers through maintain a location registration of subscriber.

### **Gateway MSC (GMSC)**

It connects mobile network to a fixed network i.e. it is the entry point to a PLMN. Usually one GMSC per PLMN is used to Request routing information from the HLR and routes the connection to the local MSC.

### **HLR - Home Location Register**

It contains semi-permanent subscriber information of all users registered with the network, HLR keeps user profile. The MSCs exchange information is also held with HLR. When MS registers with a new GMSC, the HLR sends the user profile to the new MSC.

### **VLR - Visitor Location Register**

It contains temporary info about mobile subscribers that are currently located in the MSC service area but whose HLR are elsewhere. It copies relevant information for new users (of this HLR or of foreign HLR) from the HLR. The VLR is responsible for a group of location areas, typically associated with an MSC.

**AuC: Authentication Center** is accessed by HLR to authenticate a user for service which contains authentication and encryption keys for subscribers.

**EIR: Equipment Identity Register** allows stolen or fraudulent mobile stations to be identified

**Operation subsystem (OSS):**

The Operations and maintenance center (OMC), network management center (NMC), and administration center (ADC) work together to monitor, control, maintain, and manage the network.

**Mobile Station:**

The MS consists of the physical equipment, such as the radio transceiver, display and digital signal processors, and the SIM card. It provides the air interface to the user in GSM networks. As such, other services are also provided, which include:

- Voice tele services
- Data bearer services
- The features' supplementary services

The MS also provides the receptor for SMS messages, enabling the user to toggle between the voice and data use. Moreover, the mobile facilitates access to voice messaging systems. The MS also provides access to the various data services available in a GSM network. These data services include:

- X.25 packet switching through a synchronous or asynchronous dial-up connection to the PAD at speeds typically at 9.6 Kbps.
- General Packet Radio Services (GPRSs) using either an X.25 or IP based data transfer method at the speed up to 115 Kbps.
- High speed, circuit switched data at speeds up to 64 Kbps.



The SIM provides personal mobility so that the user can have access to all subscribed services irrespective of both the location of the terminal and the use of a specific terminal.

You need to insert the SIM card into another GSM cellular phone to receive calls at that phone, make calls from that phone, or receive other subscribed services.

### GSM Channels:

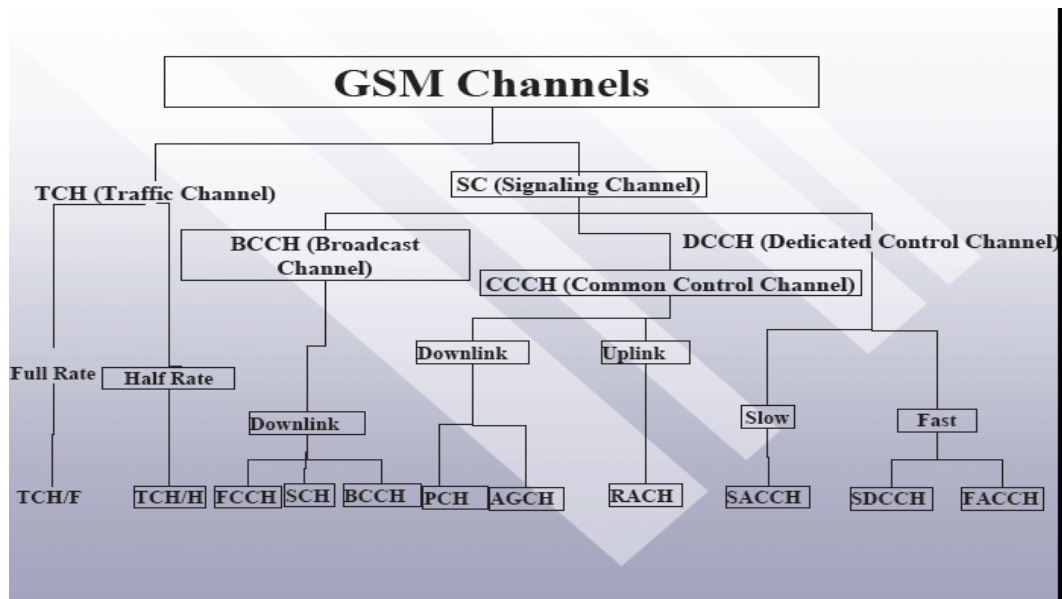

Traffic Channel (TCH) Carries user voice traffic. Traffic Channel Transfer either encoded speech or user data. It is a bidirectional data channel. When operated in Full Rate TCH it can carry data rate of 22.4kbps and during Half Rate TCH the data rate is 11.2 kbps.

Signalling Channel comprises of:

- Broadcast Channel (BCH) which is unidirectional.
- Common Control Channel (CCH) which is unidirectional.
- Dedicated/Associated Control Channel (DCCH/ACCH) is bidirectional.

Broadcast Control Channel (BCCH) connects BTS to MS. It send cell identities, organization info about common control channels, cell service available, etc. It carries Radio channel configuration information about Current cell & Neighbouring cells, Synchronizing information includes Frequencies & frame numbering and Registration Identifiers containing LA, Cell Identification (CI). Base Station Identity Code (BSIC), etc.

Frequency Correction Channel send a frequency correction data burst containing all zeros to effect a constant frequency shift of RF carrier by which the mobile station knows which frequency to use through repeated broadcast of Frequency Bursts.

Synchronization Channel send TDMA frame number and base station identity code to synchronize MSs. The MS knows which timeslot to use by Repeated broadcast of Synchronization Bursts.

Access Grant Channel (AGCH) connects BTS to MS used to assign an SDCCH/TCH to MS.

Paging Channel (PCH) connects BTS to MS by Page MS.

Random Access Channel (RACH) connects MS to BTS through Slotted Aloha protocol. It carries request for dedicated SDCCH.

Standalone Dedicated Control Channel (SDCCH) connects MS to BTS for allocation of Standalone/Independent of Traffic Channel. It is used before MS is assigned to a TCH.

DCCH (dedicated control channel) is a bidirectional point-to-point main signaling channels. it Uses timeslots which are otherwise used by the TCH. It consists of:

- SDCCH (stand-alone dedicated control channel): for service request, subscriber authentication, equipment validation, assignment to a traffic channel.
- SACCH (slow associated control channel): for out-of-band signaling associated with a traffic channel, eg, signal strength measurements.
- FACCH (fast associated control channel): for preemptive signaling on a traffic channel, eg, for handoff messages.

## **CDMA FORWARD AND REVERSE CHANNELS**

A code channel is a stream of data designated for a specific use or person. This channel may be voice data or overhead control data. In a CDMA system Channels are separated by codes, these channels are broadly categorized as forward and reverse channels.

### **Forward Channels**

The Forward CDMA channel is the cell-to-mobile direction of communication or the downlink path. It consists of:

**Pilot Channel** is a reference channel which the mobile station uses for acquisition, timing and as a phase reference for coherent demodulation. It is transmitted at all times by each base station on each active CDMA frequency. Each mobile station tracks this signal continuously.

**Sync Channel** carries a single, repeating message that conveys the timing and system configuration information to the mobile station in the CDMA system.

**Paging Channels'** primary purpose is to send out pages, that is, notifications of incoming calls, to the mobile stations. The base station uses them to transmit system overhead information and mobile station- specific messages.

**Forward Traffic Channels** are code channels used to assign call (usually voice) and signaling traffic to individual users.

### **Reverse Channels**

The Reverse CDMA channel is the mobile-to-cell direction of communication or the uplink path. **Access Channels** are used by mobile stations to initiate communication with the base station or to respond to Paging Channel messages. The Access Channel is used for short

signaling message exchanges such as call originations, responses to pages, and registrations. **Reverse Traffic Channels** are used by individual users during their actual calls to transmit traffic from a single mobile station to one or more base stations.

A CDMA channel is a pair of 1.25MHz frequency bands separated by guard-band. The guard-band may be 45 or 80MHz wide. The pair of 1.25MHz band is located either in the 82-893 MHz range in case of cellular CDMA or in the 1850-1989 MHz range in case of PCS CDMA. The guard band used in cellular is 45MHz for PCS for PCS it is 80 MHz. In both the cellular and PCS frequency ranges, CDMA channels have been identified by assigning CDMA channel numbers to the associated center frequencies for the two 1.25 MHz bands used by the channel. The channel numbers lie in the range 0-1023. Out of the two 1.25MHz bands associated with a CDMA channel, the higher frequency one is called the forward CDMA and the lower frequency one the reverse CDMA channel.

In general, each cell is assigned a specific CDMA channel which must be used by its base station and the mobiles within the cell. If the base station uses a sectorized antenna, each sector may be assigned a different CDMA channel. Thus sectorized cells may have 3 or 6 channels, instead of just one.

### **GPRS ARCHITECTURE**

GPRS architecture works on the same procedure like GSM network, but, has additional entities that allow packet data transmission. This data network overlaps a second-generation GSM network providing packet data transport at the rates from 9.6 to 171 kbps. Along with the packet data transport the GSM network accommodates multiple users to share the same air interface resources concurrently.

The GPRS specifications are written by the European Telecommunications Standard Institute (ETSI), the European counterpart of the American National Standard Institute (ANSI). Following three key features describe wireless packet data:

- Always online feature - Removes the dial-up process, making applications only one click away.
- Upgrade to existing systems - Operators do not need to replace their equipment; rather, GPRS is added on top of the existing infrastructure.
- An integral part of future 3G systems - GPRS is the packet data core network for 3G systems EDGE and WCDMA.

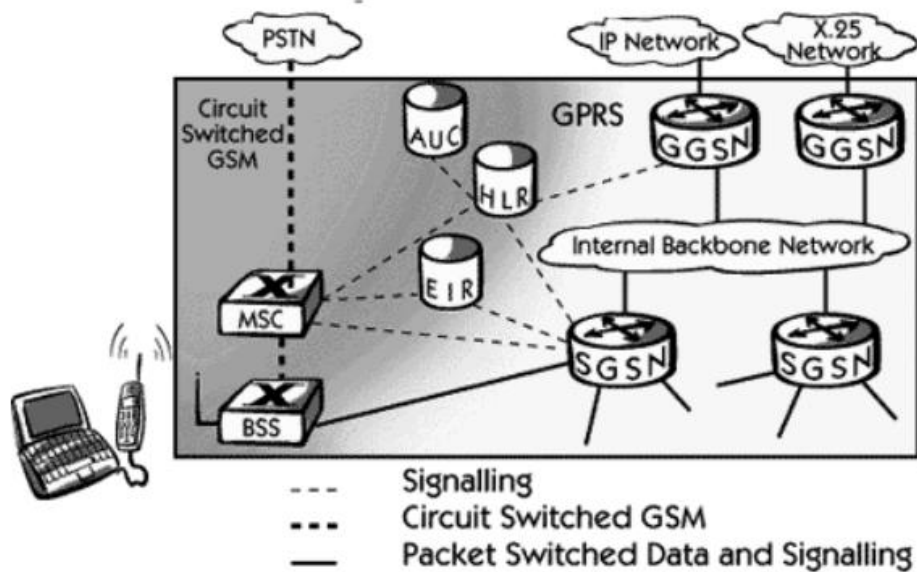

The main new network architecture entities that were needed are:

- SGSN, Serving GPRS Support Node: The SGSN forms a gateway to the services within the network.
- GGSN Gateway GPRS Support Node: The GGSN, forms the gateway to the outside world.
- PCU, Packet Control Unit: The PCU detects whether data is to be routed to the packet switched or circuit switched networks.

From the diagram given above it can be seen that the GPRS network architecture added some extra elements to the GSM network to enable it to carry the packet data. The PCU added to the base station network routed the data according to whether it was packet or circuit switched.

### SGSN

The SGSN or Serving GPRS Support Node element of the GPRS network provides a number of tasks focussed on the IP elements of the overall system. It provides a variety of services to the mobiles:

- Packet routing and transfer
- Mobility management
- Attach/detach
- Logical link management
- Authentication
- Charging data

There is a location register within the SGSN and this stores location information (e.g. current cell, current VLR). It also stores the user profiles (e.g., IMSI, packet addresses used) for all the GPRS users registered with the particular SGSN.

### **GGSN**

The GGSN, Gateway GPRS Support Node is one of the most important entities within the GPRS network architecture.

The GGSN organises the interworking between the GPRS network and external packet switched networks to which the mobiles may be connected. These may include both Internet and X.25 networks.

The GGSN can be considered to be a combination of a gateway, router and firewall as it hides the internal network to the outside. In operation, when the GGSN receives data addressed to a specific user, it checks if the user is active, then forwarding the data. In the opposite direction, packet data from the mobile is routed to the right destination network by the GGSN.

### **PCU**

The PCU or Packet Control Unit is a hardware router that is added to the BSC. It differentiates data destined for the standard GSM network (circuit switched data) and data destined for the GPRS network (Packet Switched Data). The PCU itself may be a separate physical entity, or more often these days it is incorporated into the base station controller, BSC, thereby saving additional hardware costs.

### **Wireless network generations:**

**First Generation, 1G** These phones were the first mobile phones to be used, which was introduced in 1982 and completed in early 1990. It was used for voice services and was based on technology called as Advanced Mobile Phone System (AMPS). The AMPS system was frequency modulated and used frequency division multiple access (FDMA) with a channel capacity of 30 KHz and frequency band of 824- 894MHz. Its basic features are:

- Speed-2.4 kbps
- Allows voice calls in 1 country
- Use analog signal.
- Poor voice quality
- Poor battery life
- Large phone size
- Limited capacity



- Poor handoff reliability
- Poor security
- Offered very low level of spectrum efficiency

**Second Generation (2G)** 2G refers to the second generation based on GSM and was emerged in late 1980s. It uses digital signals for voice transmission. Main focus of this technology was on digital signals and provides services to deliver text and picture message at low speed (in kbps). It use the bandwidth of 30 to 200 KHz. Next to 2G, 2.5G system uses packet switched and circuit switched domain and provide data rate up to 144 kbps. e.g. GPRS, CDMA and EDGE. The main features of 2G and 2.5G are :

- Second generation, 2G:
- Data speed was upto 64kbps
- Use digital signals
- Enables services such as text messages, picture messages and MMS(Multimedia message)
- Provides better quality and capacity
- Unable to handle complex data such as videos.
- Required strong digital signals to help mobile phones work. If there is no network coverage in any specific area, digital signals would weak.

**Third Generation (3G)** 3G is based on GSM and was launched in 2000. The aim of this technology was to offer high speed data. The original technology was improved to allow data up to 14 Mbps and more using packet switching. It uses Wide Band Wireless Network with which clarity is increased. It also offers data services, access to television/video, new services like Global Roaming. It operates at a range of 2100MHz and has a bandwidth of 15-20MHz used for High-speed internet service, video chatting. The main features of 3G are:

- Speed 2 Mbps
- Typically called smart phones
- Increased bandwidth and data transfer rates to accommodate web-based applications and audio and video files.
- Provides faster communication
- Send/receive large email messages
- High speed web/more security/video conferencing/3D gaming
- Large capacities and broadband capabilities
- TV streaming/mobile TV/Phone calls
- To download a 3 minute MP3 song only 11 sec-1.5 mins time required.

- Expensive fees for 3G licenses services
- It was challenge to build the infrastructure for 3G
- High bandwidth requirement
- Expensive 3G phones
- Large cell phones

**Fourth Generation (4G)** 4G offers a downloading speed of 100Mbps. 4G provides same feature as 3G and additional services like Multi-Media Newspapers, to watch T.V programs with more clarity and send Data much faster than previous generations. LTE (Long Term Evolution) is considered as 4G technology. 4G is being developed to accommodate the QoS and rate requirements set by forthcoming applications like wireless broadband access, Multimedia Messaging Service (MMS), video chat, mobile TV, HDTV content, Digital Video Broadcasting (DVB), minimal services like voice and data, and other services that utilize bandwidth. The main features of 4G are:

- Capable of provide 10Mbps-1Gbps speed
- High quality streaming video
- Combination of Wi-Fi and Wi-Max
- High security
- Provide any kind of service at any time as per user requirements anywhere
- Expanded multimedia services
- Low cost per-bit
- Battery uses is more
- Hard to implement
- Need complicated hardware
- Expensive equipment required to implement next generation network

**Fifth Generation (5G)** 5G refer to Fifth Generation which was started from late 2010s. Facilities that might be seen with 5G technology includes far better levels of connectivity and coverage. The main focus of 5G will be on world-Wireless World Wide Web (WWWW). It is a complete wireless communication with no limitations. The main features of 5G are:

- It is highly supportable to WWW (wireless World Wide Web)
- High speed, high capacity
- Provides large broadcasting of data in Gbps.
- Multi-media newspapers, watch TV programs with the clarity (HD Clarity)

- Faster data transmission than of the previous generation
- Large phone memory, dialing speed, clarity in audio/video
- Support interactive multimedia, voice, streaming video, internet and other
- More effective and attractive

### Block Diagram of Smart Phone

