



KIIT POLYTECHNIC

LECTURE NOTES

ON

**Mineral Processing.
(3rd Semester Metallurgy)**

Compiled by

Mr. Pramod Kumar Sethi

(Sr. Lecture, Department of Metallurgical Engineering, KIIT Polytechnic BBSR)

CONTENTS

Sl.No	Chapter Name	Page No
1	Various Mineral Resources in India	
2	Crushing	
3	Grinding	
4	Laboratory Sizing	
5	Industrial Screening Classification	
6	Gravity Concentration	
7	Heavy Media Separation	
8	Flotation	
9	Magnetic and Electrostatic Separation	

CHAPTER 1

MINERAL DRESSING

Introduction:

A metal extraction plant's working is conveniently represented by means of a flow sheet. Flow sheet is a combination of processes which are followed in the given plant to extract the metal(s) most economically. While analysing the flow sheet we come across certain *unit processes and operations*. The *unit processes* are usually characterized by certain chemical reactions such as roasting, leaching etc while *unit operations* are usually physical processes carried out discreetly on the ore. These physical processes are usually represented by crushing, grinding and similar such processes. Unfortunately there is no rigid line of distinction between them. However, from metallurgical engineering point of view any physical operation carried out on the ore to enhance its quality and make it more suitable for subsequent operations will be termed as *Ore Dressing or Mineral Beneficiation*.

So mineral dressing or ore dressing is commonly regarded as processing of raw ores to yield marketable products by such physical means those do not destroy the physical and chemical identity of the ore.

Economic Justification of Mineral Dressing:

1. To purify and upgrade the ore:

It is apparent that many ores & minerals do require some prior preparation to enhance their chemical purity and physical properties before their use in smelters.

2. Making smelting practice easier:

Hydrometallurgical extraction of metals is very slow, complex and expensive in most of the cases compared to pyrometallurgical process of extraction. In the initial stages the ores can be upgraded by employing inexpensive and simple dressing methods to make them suitable for pyrometallurgical extraction. Such an activity reduces the complexity of the smelting practice resulting in economic justification.

3. Savings on Freight:

During ore dressing the ores get beneficiated and gangue materials get separated. As the waste products are not to be transported from the mines areas, huge money is saved on freight by transporting upgraded ores.

4. Reduced losses of metal at the smelter:

As the gangue portion of the ore is separated by means of simple beneficiation methods the slag volume during the smelting process decreases. This ultimately results in a lesser loss of metal into the slag.

5. Reduction of the total smelting cost:

As there is a partial separation of gauge from the ore, lesser amount of upgraded ore is to be smelted for a particular output capacity. This reduces the fuel and energy consumption per ton of metal smelted.

6. Reduction of the total smelting cost:

As there is a partial separation of gauge from the ore, lesser amount of upgraded ore is to be smelted for a particular output capacity. This reduces the fuel and energy consumption per ton of metal smelted.

7. Reduction of the total smelting cost:

As there is a partial separation of gauge from the ore, lesser amount of upgraded ore is to be smelted for a particular output capacity. This reduces the fuel and energy consumption per ton of metal smelted.

8. Reduction of the total smelting cost:

As there is a partial separation of gauge from the ore, lesser amount of upgraded ore is to be smelted for a particular output capacity. This reduces the fuel and energy consumption per ton of metal smelted.

9. Enhancing the efficiency of unit processes:

Sometimes the ore is separated into one or more valuable products and a tailing. This leads to separation of certain minerals which interfere seriously with smelting or leaching. Hence complex ores require prior separation or processing treatment for economical smelting.

Scope of Ore Beneficiation:

Previously selective mining practices were followed. But after the development of inexpensive ore beneficiation methods, bulk mining practices have proved to be more economical compared to careful selective mining. In a general way the scope of mineral dressing or ore beneficiation is twofold:

1. It helps in eliminating unwanted chemical species from the bulk of the ore.
2. It helps in eliminating particles improper size and physical structure which may adversely affect the working of smelters, roasters etc. This implies production of ore particles of specific size range with proper physical properties is of great importance.

Of the above scopes, first one is more important and is considered to be the extent or working sphere of ore dressing. The second one is also equally important for proper smelting operation.

Size parameter of ore particles controls the flue dust loss, reaction kinetics & extent of metal loss as the unreduced ore finally passes off into the slag. The *objectives* of mineral dressing are as follows:

1. To eliminate unwanted chemical species:

To prepare the ore particle from chemical stand point, primarily involving the following steps:

- a. Liberation of dissimilar particles from each other appearing in the bulk ore.
- b. Separation of chemically dissimilar particles.

2. To prepare ore from physical standpoint.

This involves:

- a. Reduction in size.
- b. Separation of particles of dissimilar physical nature.

So the first step in ore beneficiation is size reduction causing liberation. This is followed by separation of liberated particles as the second step in the process. These two steps are made to alternate to accomplish the desired end product most economically.

GENERAL OPERATIONS INVOLVED IN ORE DRESSING:

1. Comminution:

Comminution or size reduction can be accomplished dry or wet.

2. Sizing:

This is the separation of product material into various fractions depending on their size parameter.

3. Concentrating:

Concentration of valuable portion of the ore is obtained by the various means which generally involve physical characteristics of the ore particles. Sizing, jigging, tabling, classification, magnetic & electrostatic separation are few such examples. We may exploit an entirely different set of physio-chemical properties for concentrating the ore as it happens during froth flotation.

4. De -Watering:

Where aqueous medium is involved, water is to be removed before smelting can take place. This involves:

- a) Removal of most of the water by the use of the thickener.
- b) Then use of filter presses to prepare a damp cake of the concentrated ore.
- c) Then drying the cake in a furnace.

CHAPTER 2

SIZE REDUCTION METHODS

Introduction:

The crude ore from the mines contain a number of solid phases in the form of an aggregate. The valuable portion of the ore is known as *mineral* while the worthless portion is known as *gangue*. During ore dressing, the crude ore is reduced in size to a point where each mineral grain becomes essentially free so as to make separation between them. Such a phenomenon of making the mineral grains free from gangue in an ore is termed as liberation. This is practically carried out by size reduction performed by crushers and grinding mills.

The ore lumps from the mines have the lump size of 10 - 100 cm while the individual minerals have grain sizes below 0.1 mm. Hence, the first step in any ore dressing plant is to aim at liberation by size reduction or comminution.

Comminution of any ore is carried out in several stages using different crushing equipments. So the objective crushing is to reduce the large lumps in to smaller sizes. Depending upon the feed and product particle size, the crushing operation can be classified as follows:

1. Primary crushing:

The feed material is usually the run of mine.

2. Intermediate crushing or secondary crushing:

The feed material is usually product of a jaw crusher.

3. Fine crushing or coarse grinding:

The feed material is usually comes from the secondary crushers.

4. Fine Grinding:

The objective of fine grinding is to produce ultrafine material less than one micron.

Size Parameter for Different Comminution Processes:

Suitable parameters of feed and product material for different crushing operations are shown in the table.

Table.

Process	Feed Size	Product size
1. Coarse Crushing	ROM(150-4cms)	5.0- 0.5 cm
2. Intermediate crushing.	5.0 - 0.5cm	0.5 -0.0 I cm
3.Coarse grinding	0.5.0 - 0.2cm	About 75 microns
4. Fine Grinding (Special type)	(0.02 cm)	0.01 microns

Energy Requirement for Different Comminution Processes:

Different size reduction practices requires different amount of energy as shown in the table.

Table.

Process	Average Energy Consumption (kWh/ton)
1. Coarse Crushing	0.2- 0.5
2. Intermediate crushing.	0.5 - 2
3.Coarse grinding	1.0 -10
4. Fine Grinding (Special type)	2 - 25

Mechanism of Size Reduction:

Crushing is a mechanical operation in which a force of large magnitude is applied to a relatively brittle solid material in such a direction that its failure takes place. The theory of size reduction for solids is quite complex, but can be attributed to the action of following forces acting on the particle:

1. A huge compressive force exceeding the ultimate strength of the material may be responsible for size reduction as actually happens in case of jaw, gyratory and roll crushers.
2. A sufficiently high impact force may be responsible for size reduction. Impact force is largely utilized in hammer & ball mills.
3. Attrition, rubbing action or frictional forces may be utilized for size reduction. Such action is largely responsible for crushing in attrition mill, tube and pebble mills.
4. Cutting force is utilized in knife edge mills to reduce the size of fibrous materials like mica, asbestos.

At least one or a combination of the above forces is always involved in size reduction in any crushing equipment.

Basic Requirements of Crushing Equipments:

An ideal crusher or grinder should have the following characteristics:

- a. It should have a large capacity.
- b. It should require a small (energy) input per unit weight of production.
- c. It should yield a product of uniform size or in the required size range.

The performance of different crushing operation is studied individually with respect to the ideal operating conditions. A classification of the size reduction equipments can be made on the basis of feed and product size as follow:

Classification of the Size Reduction Equipments: (In The Order Of Finer Size Product)

A. Primary Crushers:

1. Jaw crusher.
2. Gyratory crusher.

B. Intermediate crushers:

1. Crushing rolls.
2. Cone crusher.
3. Disc crusher.

C. Fine crushers or Coarse Grinders:

1. Ball Mill.

D. Fine Grinders:

1. Rod mill.
2. Pebble mill.
3. Tube mill.
4. Hammer mill with internal classifier.

Primary Crushers:

Crushers are slow speed machines for coarse size reduction of large quantities of solids. The major types of crushers are: Jaw, Gyratory, Roll & Toothed roll crushers. The first three types operate on compressive force and can crush very hard & brittle rocks. The toothed roll crusher tears the feed apart as well as crushes it. It works best on softer materials like coal, bone and soft slate. These are the crushers which operate on the run of the mine (*rom*). Primary crushers are of two types:

1. Jaw crusher.
2. Gyratory crusher

Classification of Jaw Crushers:

From capacity and working mechanism point of view jaw crushers are three types such as:

1. Blake crusher.
2. Dodge crusher.
3. Universal crusher.

The functional figure of different jaw crushers are as shown schematically in the figure.

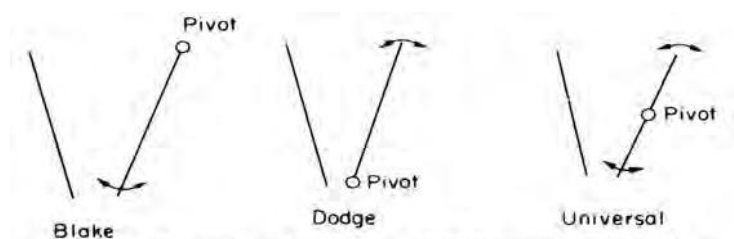

Fig-- Functional figures of different jaw crushers.

Blake Jaw Crusher:

It is a primary crusher used most widely. It has its moving jaw pivoted (hinged) at the top as in the figure 2.1a. Though the working principles of Blake and Dodge crushers may be different from constructional point of view they are almost identical excepting two notable differences which will be discussed afterward. The Blake crusher may be classified as *single toggle* or *double toggle* type.

Constructional Features:

As the name suggests a jaw crusher has two jaws set to form a V-shape at the top through which feed is admitted into the jaw space. One of the jaws is fixed to the main frame of the crusher almost vertically while the other one is movable. The swinging jaw, driven by an eccentric, reciprocates in a horizontal plane and makes an angle of 20- 30 degrees with the stationary jaw. It applies a huge compressive force on the ore lumps caught between the jaws. The schematic figure of the Blake crusher is shown in the figure 2.2.

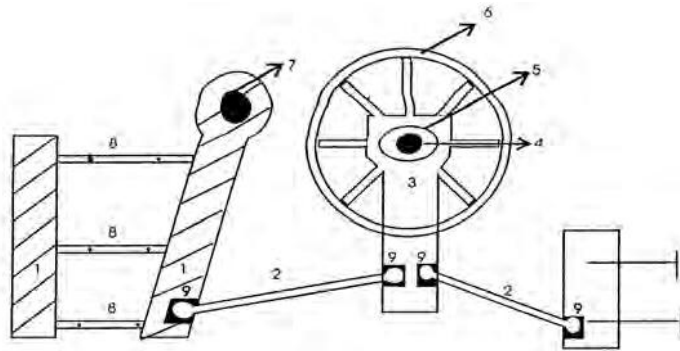

1. Jaw Plates 2. Toggles 3. Pitman 4. Main Shaft
5. Eccentric 6. Flywheel 7. Top hinge 8. Check P
9. Bearings
[Blake Jaw Crusher]

On the jaws, replaceable crushing faces are fixed by nut & bolt arrangement. The crushing faces are made of *hadfield manganese steels*. When extensive wear is observed on any of the faces it is replaced with a new one. The crushing faces are rarely flat. They are usually wavy surfaces or may carry shallow grooves on them. The jaw running speed vary from 100-400 rpm.

The jaw widths vary from 2" to 48". The important features of jaw crusher are as follow:

As the moving jaw is pivoted at the top, the amplitude movement is largest at the bottom. The maximum distance the moving jaw travels is called *throw* of the crusher. The throw varies from 1-7cm. Jaw crusher is rated according to their receiving area, i.e., the *length* of the jaw plates and the *gape*. *Gape* is defined as the distance between the jaw plates at the feed opening end. For example an 1830X1220mm crusher has a *length (L)* of 1830 and a *gape* of 1220mm. For jaw crushers the *length or width* is usually greater than *gape*. The Blake crusher has a varying discharge opening. This distance between the jaws

in the discharge side is termed as $set(S)$.

These parameters are shown schematically in the figure.

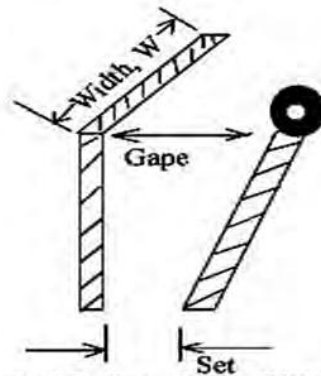

Fig. 1.2. Gape, Set & Width of a Jaw crusher.

Initially the large lump is caught at the top and is broken. The broken fragments drop to the narrower bottom space and is crushed again when the jaws close in next time. This action continues until the feed comes out at the bottom. The crushing force is least at the start of the cycle and highest at the end of the cycle. In this machine an eccentric drives the pitman. The circular motion of the main shaft is converted to up and down motion of the pitman via the eccentric and finally the *up and down* motion is converted to *reciprocating(to and fro)* motion with the help of two toggles. One of the toggles is fixed to the main frame and pitman while the other one is fixed to the moving jaw and pitman. From mechanical stand point, toggles are the weakest members of the jaw crusher. This is specifically made so to work as a safety device for the entire jaw crusher installation. There is every probability that an extremely hard material may enter into the jaw space along with the usual feed.

Such an occurrence starts developing a huge stress on the machine members. The stress would continue as long as the hard particle is not crushed. This may lead to situations where the jaw crusher would be severely damaged. Such a situation is avoided as the toggle(s) fails beyond a particular stress level being the weakest link of the jaw crusher members. Hence toggle(s) actuates the moving jaws and simultaneously work as a safety device for the jaw crusher. The failed toggles can be replaced with new ones without much problem. In crushers, the toggle plates are designed to take only a predetermined load.

Another important component of the Blake jaw crusher is the flywheel fitted onto the main shaft. The use of fly wheel is quite important from design point of view. As crushing takes place only during the forward stroke, intermittent and uneven load works on the machine members. To equalize this uneven load one or a number of flywheels are used on the main shaft. During the back-stroke, the material that has already been crushed is allowed to drop freely through the jaws. Forced feed lubrication is the rule in the jaw crushers. The machine is not operated very rapidly to restrict the production of fines.

Characteristics of Blake jaw crusher:

1. Reduction Ratio:

Blake crushers are the primary crushers. As the moving jaw is pivoted at the top it makes minimum and maximum swing at the top and bottom respectively. The maximum distance travelled by the moving jaw is defined as *throw* of the crusher. Blake jaw crushers have fixed *gape*. The width or length of the feed receiving opening is somewhat greater than the *gape*. The *set* determines the product particle size. Depending upon the *gape* & *set* the size reduction ratio (*R.R.*) generally available varies from 4-7. For a crusher the *R.R.* is defined as the ratio between average feed size to average product size.

Mathematically:

$$\text{Reduction Ratio (R.R.)} = \frac{\text{Average Feed Size}}{\text{Average Product Size}}$$

This is a very important parameter for determining the energy consumption in the crusher. Keeping all other variables fixed, higher the reduction ration (*R.R.*) higher is the energy consumed by the crusher.

2. Capacity:

The capacity of the jaw crusher mainly depends on the length and width of receiving opening and the width of discharge. As per Taggart, the empirical formula for capacity of jaw crusher is: $T = 0.6LS$ where,

T is the capacity expressed in tons per hour.

L is the *length or width* of the receiving opening in inches.

S is the *set* or width of discharge opening in inches.

The above empirical relation is quite accurate except for smallest and largest jaw crushers. The capacity of a jaw crusher may be as high as 725tons per hour for 2250x1680mm jaw size.

3. Energy Consumption and Efficiency:

Energy consumption in a jaw crusher varies considerably. Largely it depends on following factors:

- a. Size of feed
- b. Size of Product
- c. Capacity of the machine
- d. Properties of rock such as hardness, specific gravity, etc.

The energy utilization analysis in a crusher was first carried out by Owens. As per his conclusion the energy consumed in a jaw crusher is utilized in the following manner:

1. In producing elastic deformation of the particle before fracture occurs.
2. In producing plastic deformation which results in fracture of the particle.
3. In causing elastic distortion of the equipment.
4. Frictional losses between the particle & the machine.
5. Noise, heat & vibrational energy losses in the plant.

It has been estimated that only 10 - 20% of the total input energy is consumed for size reduction and the rest is lost in the machine in various ways. Out of the total energy consumed, largest amount gets converted to heat energy during crushing. Further this amount increases as the size reduction ration increases.

The jaw crushers are quite inefficient machines. The efficiency can be modified a little by analyzing the modes of energy utilization in a crusher. Proper lubrication and reduction in frictional losses can only increase the efficiency of the crusher. Further the physical properties of the ore which affect the efficiency of crushing are:

1. Specific gravity of the ore.
2. Hardness of the ore.
3. Moisture content in the ore.

4. Structural weakness planes of the ore.

Dodge Crusher:

Both Dodge and Blake crushers look similar to each other. In Dodge crusher the moving jaw is pivoted at the bottom in place of the top as in case of Blake crusher. Hence the maximum swing of the moving jaw is obtained at the top. The *gape* is a variable while width of discharge opening (*set*) is fixed. Due to the fixed *set*, the product is more uniformly sized as compared to the product from the Blake. The crusher has got fewer mechanical parts as compared to Blake crusher. The moving jaw is activated by a lever. It is activated by a lever-eccentric arrangement mounted onto the main shaft as compared to the toggle-pitman combination in case of Blake crusher. Dodge crusher is shown schematically in the figure 2.4.

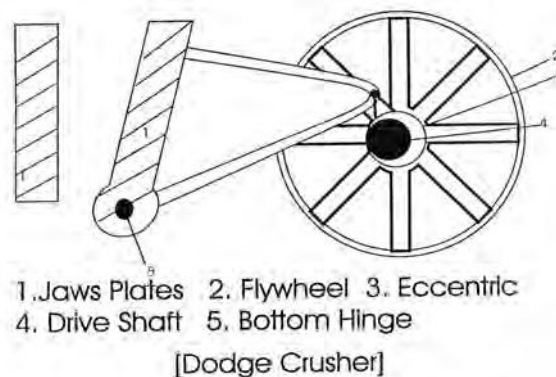

The inherent problem with this crusher is its tendency to choke frequently and that is why it is used less widely. This crusher is usually made in smaller size than the Blake crusher because of high fluctuating stresses working on the machine members. The major advantage of this machine is its power to effect larger size reduction because of larger-opening at the top with a fixed set. The advantage of uniform product size is the most significant where a single crusher is used as the only comminution machine. In industries where elaborate screening is available Blake crusher is preferred because of its higher capacity and more balanced mechanical design. The Dodge crushers are usually used in college and research laboratories. A comparison between Dodge and Blake jaw crusher is made in the table.

Comparison between Blake & Dodge Crusher:

Blake Jaw Crusher	Dodge Jaw Crusher
1. It has got two toggles.	It has one toggle in the form of a lever.
2. It has one pitman.	It has no pitman.
3. The movable jaw is pivoted at the top, so has a variable product discharge opening while feed receiving opening is fixed.	The movable jaw is pivoted at the bottom so the discharge opening is fixed. The set is fixed, while the feed receiving opening varies. This results in almost uniform sized product.
4. No choking takes place here as it has variable discharge. It operates on principle of forced feed.	Choking is a very common problem as the set is quite small compared to receiving opening.
5. This crusher is mechanically more balanced and has fewer breakdowns. Further it is built for much larger capacity.	Mechanically the design of this crusher is inferior. So it is built only to lower capacity. This machine has more breakdowns as compared to the other.
6. Product size distribution is large & produces more fines.	Product size distribution is more uniform.
7. Blake is preferred at large industrial setups where elaborate screening facility is available along with other comminution machines. out.	A dodge is preferred where jaw crusher is to be used as the only comminution equipment.
8. This machine is of higher cost for same output.	This machine is cheaper for same output.
9. Because of forced feed lubrication it yields a coarser product.	As choke feeding is possible, it can yield a much finer product.

Gyratory Crusher:

Classification of Gyratory Crusher:

Gyratory crushers have been developed recently in order to supply a machine with a larger capacity than jaw crushers.

The best known gyratory crushers are:

1. Suspended spindle gyratory crusher.
2. Parallel Pinch or Telsmith gyratory crushers.

Of late the suspended spindle gyratory has been obsolete and only the parallel pinch gyratory is used widely. Theoretically the parallel pinch is not a gyratory

crusher since the crushing head rotates eccentrically instead of gyrating.

It consists of two substantially vertical truncated conical shells. The outer shell has its apex pointing down while the inner cone has its apex pointing up. The outer conical shell is fixed rigidly to the main frame while the inner cone or the crushing cone is mounted on a heavy central shaft also known as spindle.

The upper end-of the shaft is held in a flexible bearing while the lower end is driven by an eccentric so as to describe a circle. Because of this eccentric rotation, the inner cone thus rotates inside the outer cone alternately approaching and receding from all the points on the inner periphery of the outer shell. The solids caught in the V-shaped space between the crushing heads are broken repeatedly until they pass at the bottom. The crushing action takes place all over the cone surface. Fig.2.1. shows the functional elements of a suspended spindle gyratory crusher.

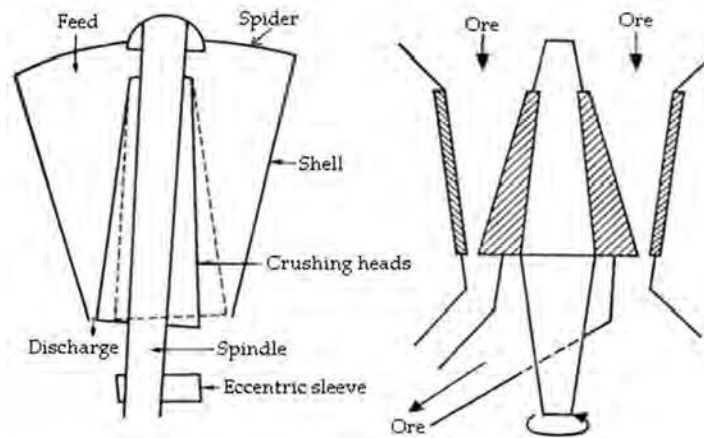

Fig. 2.5. Functional Elements of Suspended Spindle Gyratory Crusher.

Since the jaw movement is largest at the bottom, the operational characteristics of the gyratory crusher are similar to Blake jaw crusher. The machine operates continuously throwing product all around the periphery at different instants. When one point on the periphery is involved in crushing the opposite point is set at maximum opening to accept feed into the V-shaped crushing head. This crusher mainly employs compressive force for size reduction. The materials for crushing head is had field manganese steel in cast form. The gyration speed varies from 125-425 r.p.m. As the gyratory crusher operates continuously, for an equivalent size of the crushing heads, the capacity per unit area of grinding surface of the gyratory crusher is much larger than that of Blake jaw crusher. As the crushing action is continuous, the fluctuating stresses on machine members are minimized and it consumes less power. Thus it has a better efficiency compared to jaw crusher. The product from gyratory crusher is much more uniform compared to the jaw crusher. Because of the high capital cost, the crusher is most suitable for very large output.

Characteristics of Gyratory Crusher:

1. At any cross section there are in effect two sets of jaws opening and closing alternatively like a conventional jaw crusher. Hence gyratory crusher can be regarded as a series combination of infinitely large number of jaw crushers of infinitely small width. Hence the capacity of the gyratory crusher is much greater than that of a jaw crusher having equivalent gape size.
2. It has more regular power draft due to continuous crushing action.
3. With respect to the reduction ratio, at fixed power consumption and equivalent capacity, both jaw and gyratory crusher are at par.
4. The rule of installing a gyratory crushers or jaw crusher is given by Taggart as follows:

If the hourly tonnage to be crushed divided by square of gape expressed in inches yields a quotient less than 0.115 than use a jaw crusher or else use a gyratory crusher.

Mathematically:

If, $\frac{T}{Gape^2} > 0.115$, select Gyratory crusher.

And, $\frac{T}{Gape^2} < 0.115$, select Jaw crusher ,

Where, T is expressed in tons per hour and $gape$ is expressed in inches. A comparison between jaw and gyratory crushers is given in the table

Comparison between Jaw & Gyratory Crusher:

Jaw Crusher	Gyratory Crusher
The loading on machine components is intermittent and the power draft irregular.	Uniform loading on the machine components with regular power draft.
Crushing action is intermittent.	Crushing action is almost continuous.
For a particular gape size the capacity is less compared to gyratory crusher.	For the same gape size the capacity is much larger.
Its feed acceptance size is much larger compared to gyratory crusher.	Its feed acceptance size is much less compared to jaw crusher for the same capacity.
Product particle size distribution varies widely & it has a reduction ratio less than that of the gyratory crusher.	More uniform sized product is obtained with a larger $r.r.$
Power consumption is higher for jaw crusher for a particular $r.r.$ & capacity.	With the same $r.r.$ & capacity, the gyratory crusher requires less power.
The crusher is less efficient compared to gyratory crusher It has an efficiency of 10 -20%.	It has an efficiency of 30 - 50%.
The wear on the jaw plates is not uniform which causes heavy wear on the jaw plates at certain areas. The jaw plates are replaced frequently.	The wear on the crushing cone is quite uniform. If the bottom opening changes, the inner cone can be lifted up by the variable bearing to reduce the gap. So the heads can serve for a longer time.
Not much variation can be obtained with regards to product particle size.	Wide variation in product size can be obtained by varying the setting of the central shaft. The set can be varied as per requirement.
It has a low cost of installation.	It has a high cost of installation.
It is better for lower production rates.	It is better for higher production rates.

Intermediate Crushers:

Generally products from the jaw crusher or gyratory crusher are not fine enough for the complete liberation of mineral grains and needs further size reduction. The product is charged into either cone crusher or crushing rolls for further size reduction. Cone crushers and crushing rolls are the equipments for intermediate range crushing.

Cone Crusher:

This type crusher is a newer development. They have gained wide popularity because of their economical operation in the intermediate range. The general types are: Simon's Cone Crusher and TelSmith Gyrosphere.

The construction of this cone crusher is much similar to gyratory crusher (Figure 2.6.) though the feed size is much smaller and the product is much finer. Here both the rotating inner cone & stationary outer cone apex point upwards. The outer stationary cone is fixed on to the main frame while the inner

crushing head is mounted on a heavy central shaft rotating eccentrically. The material used as crushing heads is *hadfield manganese* cast steel containing at least 12% Mn. The sectional view of a cone crusher is shown in the figure 2.6.

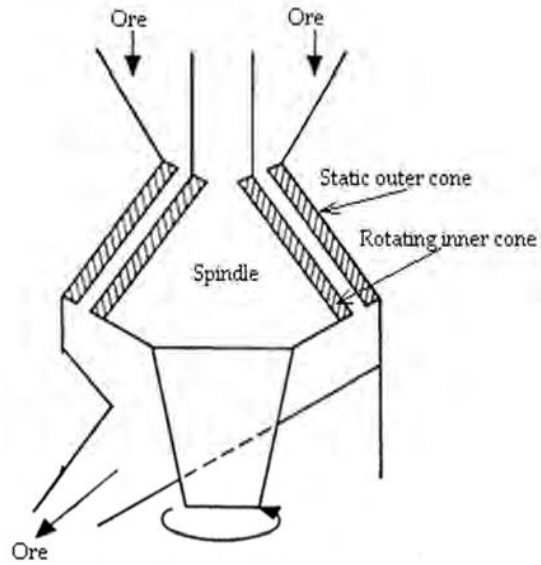

Fig.2.6. Sectional view of a Cone Crusher.

The central shaft is fixed with an adjustable bearing and is mounted on an eccentric drive. Due to the adjustable bearing on the central shaft, the position of the internal cone can be altered so as to provide a variable discharge opening (*set*) as per the requirement. This arrangement also takes care of the wear on the crushing faces which may enlarge the set. The eccentric performs the same work as does in the case of gyratory crusher.

Due to this the inner cone (crushing head) alternately approaches and recedes from a particular point on the periphery of the outer cone resulting in continuous crushing action. This results in regular power draft and much finer product at a better efficiency. The efficiency of the Cone crusher is comparable to that of the gyratory crusher.

The crushing forces here are compressive and frictional in nature. Compared to crushing rolls they have better capacity with comparable product fineness. To operate the cone crushers most efficiently, a dry feed, free from fines are to be used. If wet ore is used the cone crushers may clog. The problem of clogging in cone crushers makes it necessary to use efficient screens in closed circuit with them.

LIMITATIONS:

1. It operates only on closely sized brittle material.
2. It has a low reduction ratio.
3. It needs extensive lubrication of all its moving part regularly.
4. It operates best in closed circuit grinding.

Crushing Rolls:

This is an important class of intermediate comminution machine in the intermediate range of size reduction. Crushing rolls consists of pair of heavy cylindrical rolls revolving towards each other so as to nip a falling ribbon of rock and discharge it crushed below rolls. They were invented around 1850A.D.

Mechanical Design:

The two rolls are heavy and rigid ones. The material is cast steel and wear resisting. Both the rolls are positively driven towards each other by motors. The heavy rolls turn on parallel horizontal plane having the roll centres at the same height separated by a distance, S . The feed caught between the rolls

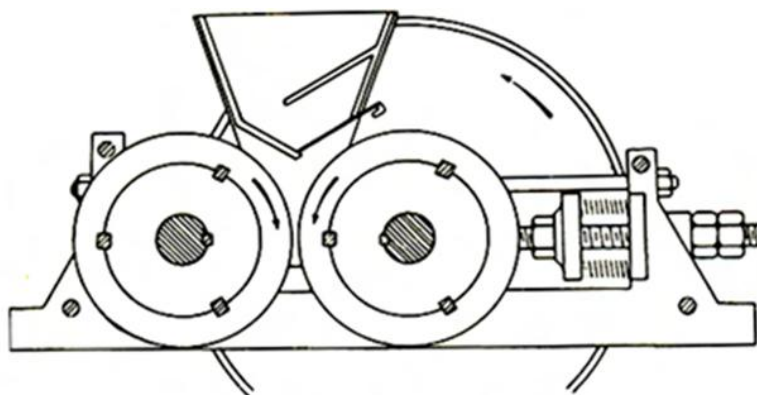

Fig.2.7. Schematic Crushing Rolls.

are broken by compressive force and drop down below. The rolls turn towards each other at the same speed. They have narrow faces but have large diameter so that they can nip moderately large lumps. Figure 2.7. shows the crushing rolls schematically.

Typical rolls are 600 mm long with 300 mm diameter. Roll speed ranges from 50 - 300 rpm. The feed size varies from 12-75mm & the product size varies from 12 to 20 mm. The product size mainly depends on the roll separation distance d . The operation is quite continuous. At a lower reduction ratio the crushing rolls produce less fines as compared to other crushers. However, the crushing rolls have large capacity at lower reduction ratio. The roll clearance d is adjustable and depends on feed size and product size requirement. The machine is protected against damage from very hard material, by the spring loader mounted onto the rolls. When a hard material, having breaking strength is higher than the strength of the spring loader, is nipped the rolls simply widen allowing the hard rock to drop down without being crushed. The most important characteristic of a roll crusher, which controls the crushing activity, is the *angle of nip* or *angle of bite* of the rolls. This can be deduced mathematically.

Angle of Nip:

It is defined as the angle subtended between the two tangents drawn at the points of contact of the rolls and the particle to be crushed. *Angle of nip* is also termed as *angle of bite*. Crushing is performed only when the ore particles are nipped properly by the rolls. The Particle that can be nipped by the crushing rolls depends largely on the following factors:

1. Roll diameter (D).

2. Particle diameter (d).
3. Inter roll distance (S). Assuming the particle to be spherical.
4. Friction factor between the roll & the mineral (μ).

These parameters are shown schematically in the figure 2.8. The angle of nip is represented as 2θ in the figure.

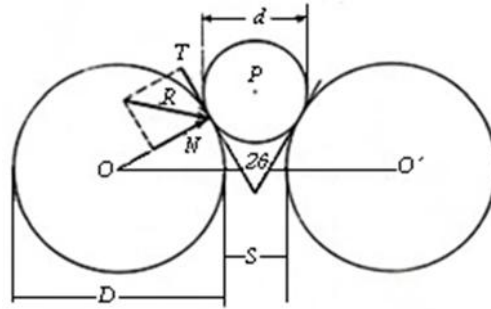

Fig.2.8. Angle of Nip in Roll Crushing.

Neglecting the effect of gravity on the ore particle a mathematical relation regarding feasibility of nipping and subsequent crushing can be deduced as follows:

Let the reaction & friction force at the contact point are F_T and F_N respectively (refer fig.2.8). The particle will be nipped leading to crushing only when the resultant R of the forces F_T and F_N is directed downward otherwise the particle will fly-off from the V-space of the rolls. Further it can be shown that the horizontal components of the forces are not responsible in dragging the particle into the roll gap. It is only the vertical components of the forces are responsible for dragging the particles into the roll gap for crushing. Hence the limiting condition of crushing is that, "The sum of the vertical components of all the forces at the contact point between the ore and roll should be at least equal to zero ($\sum F_{vertical} \geq 0$).

The vertical components of F_T and F_N are $F_T \cos\theta$ and $F_N \sin\theta$ respectively. As per the limiting condition of crushing:

$$F_T \cos\theta = F_N \sin\theta$$

$$\text{Or, } \frac{F_T}{F_N} = \frac{\sin\theta}{\cos\theta} = \tan\theta$$

Hence necessary and sufficient condition for crushing is:

$$F_T \cos\theta \geq F_N \sin\theta \Rightarrow \frac{F_T}{F_N} \geq \tan\theta \text{ --- (1)}$$

$$\text{From the laws of mechanics we have, } \frac{F_T}{F_N} = \mu,$$

μ is the coefficient of friction at the ore particle and roll contact point.

Hence the equation (1) changes to:

$$\mu \geq \tan\theta \text{ --- (2) where } \theta \text{ is half angle of nip.}$$

Now the interrelation between D , d , S and θ can be found out by

considering the triangle OPM with reference to the figure2.9. In the triangle

$$\text{OPM we have: } \cos \theta = \frac{OM}{OP} = \frac{D + S}{D + d} \text{ --- (2)}$$

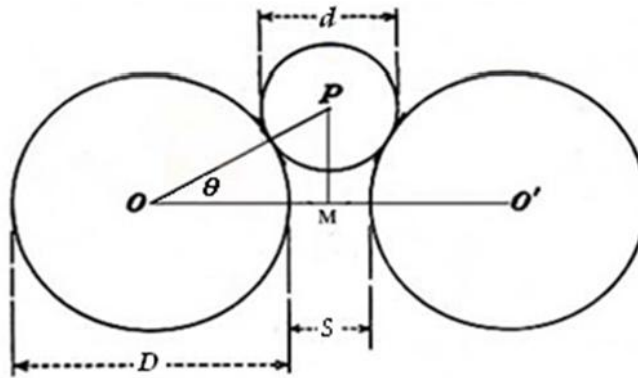

Fig.2.9. Inter-relationship between D, d, S and angle of nip (θ)

In most of the cases limiting size of the particle that can be nipped is estimated by a simple relation, $d_{\max} = (0.04R + S / 2)$, where R is the roll radius and S is the inter roll distance or gap. The coefficient of friction between steel and most of the ore particles is in the range of 0.2 - 0.3, so the angle of nip 2θ should never be above 30° else the particle will slip.

The kinetic friction, μ_k between particle and moving rolls can be computed from the equation: $\mu_k = \left[\frac{1+1.2v}{1+6v} \right]$, where, v is the peripheral speed which is around $1ms^{-1}$ for smaller rolls and $15ms^{-1}$ for larger rolls having a

diameter of 1800mm or more.

Characteristics of the Crushing Rolls:

1. It has a reduction ratio ($r.r$) is around 3 - 4 only which is very low compared to other size reduction equipments.
2. It yields a uniform sized product.
3. The product of the crushing rolls contains fewer fines as the mastification time is limited and no repeated crushing takes place.
4. Capacity:

Capacity of the roll crusher depends on the following factors:

- i. Speed of revolution (N).
- ii. Width of the faces (W).
- iii. Diameter of the rolls (D).
- iv. Set (S), the inter roll distance
- v. Specific gravity of rock () lb/in^3

The theoretical capacity in tons/hr is given by the expression:

$$C = 0.0034 N DWS\rho, \text{ where } W, D \text{ \& } S \text{ are expressed in inches and } \rho \text{ in } lb/in^{-3}.$$

Or, $C = 1.885 N DWS\rho \text{ kgh}^{-1}$, where $W, D \text{ \& } S$ are expressed in meter and ρ is expressed in $kg \text{ m}^{-2}$. The actual capacity is considerably less and is only around 10-30% of the theoretical capacity. If the set(S) is nil the capacity of the rolls is also nil.

6. Rolls can be operated either wet or dry. Dry crushing has a lower output but causes lesser wear of the rolls.
5. It is best operated on choke feeding for maximum output. In open feeding the output is less.

Uses:

The rolls are most suitable in effecting only a smaller size reduction in a single operation. Therefore, it is common to employ a number of pair of rolls in series to achieve higher reduction ration. Crushing rolls are extensively used in crushing oil seeds, gun powder and coal because of lower residence time of the feed as lower residence time reduces the effect of heat on the feed material.

Feeding Systems in Comminution Equipments:

There are two distinct methods of feeding material to a crusher. They are:

- a. Free Feeding.
- b. Choke Feeding.

Free feeding:

This involves feeding of material at a comparatively low rate so that the product can readily escapes out of the machine. As the residence time of the feed material in the machine is short and production of appreciable quantity of undersized or fines are avoided. This reduces the chances of clogging of the machine. The reverse of the free crushing method is termed as choke feeding.

Choke feeding:

The second method of feeding is known as choke feeding. In this case the machine is always kept full with material and the discharge of the product is impeded by retaining the ore in the machine for a longer time. This results in a higher degree of crushing at a reduced capacity of the machine. Energy consumption is higher because of the cushioning action produced by the accumulated product. Dodge crusher generally works on this type of feeding method. The most important problem of this type of feeding system is the clogging of the crusher causing higher wear on the crusher faces or even ultimate failure of the machine. This method is, therefore, used only when a comparatively small amount of material is to be crushed and it is desired to achieve the total size reduction in one operation. It is usually desirable to avoid choke feeding.

Open and Closed Circuit Grinding Operations:

The usual meaning of grinding here is comminution and has nothing to do with the product particle size. In many mills the feed is broken into particles of satisfactory size by passing it once through the mill. When no attempt is made to return the oversized particles in the product once again to the crusher for further size reduction the product simply passes off to the next stage of size reduction. Such a method of size reduction at various stages till the desired product is obtained is termed as *open circuit grinding*.

A bright example is a Dodge crusher operating on choke feeding. This grinding may require an excessive amount of power and much of the energy is wasted in regrinding the particles that are already fine enough.

In another method the partially crushed material is screened and the oversized material is returned back to the crusher for further crushing and the undersized product is given as the feed to the next machine for further size reduction. If such a method is followed in all successive crushers till the desired

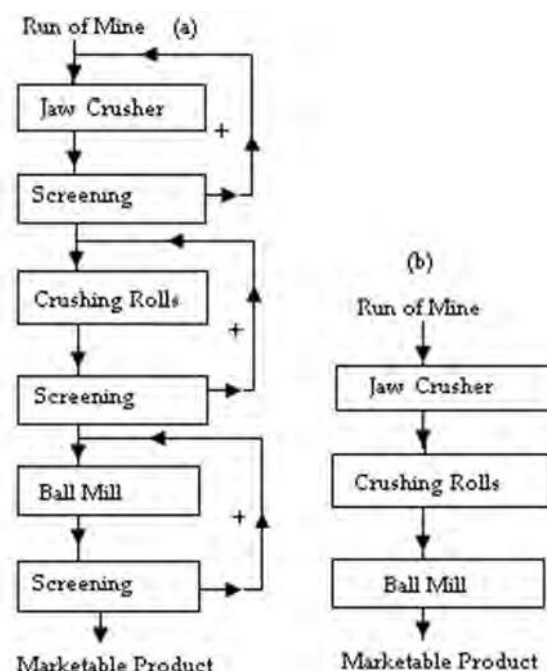

Fig. 2.11. (a) Closed and (b) Open circuit Grinding.

product is obtained it is termed as *closed circuit grinding*. This method of grinding operation is generally adopted as such a process has been found to be economical making full capacity utilization of all equipments efficiently. This process avoids unnecessary regrinding. Fig. shows the scheme of closed and open circuit grinding.

Fine Crushing or Grinding:

The fine crushing or grinding means product size less than 6mm and going down up to $200\#(74\mu\text{m})$. The usual meaning of grinding is the comminution of an ore particle that has already been reduced to a size less than 6mm size by crushing.

Hence any comminution process aiming at a product size less than 6mm size is known as grinding. Grinding is a slower process usually carried out in a ball or tumbling mill or any other equipment like tube, rod & pebble mill. These mills perform size reduction in closed chambers containing hard balls, rods or quartz pebbles as grinding media.

Classification of Ball Mills:

Ball mills can be classified according to the

- a. Shape of the mill.
- b. Methods of discharge of the ground ore.
- c. Weather the grinding is conducted dry or wet.

1. Shape of the Mills:

According to the shape the mills are classified as:

1. Cylindro-conical mills: Harding mill (where feed & discharge ends are fixed).
2. Cylindrical mills. This represents the usual ball mills.

Figure 2.12 shows the shape of different ball mills schematically.

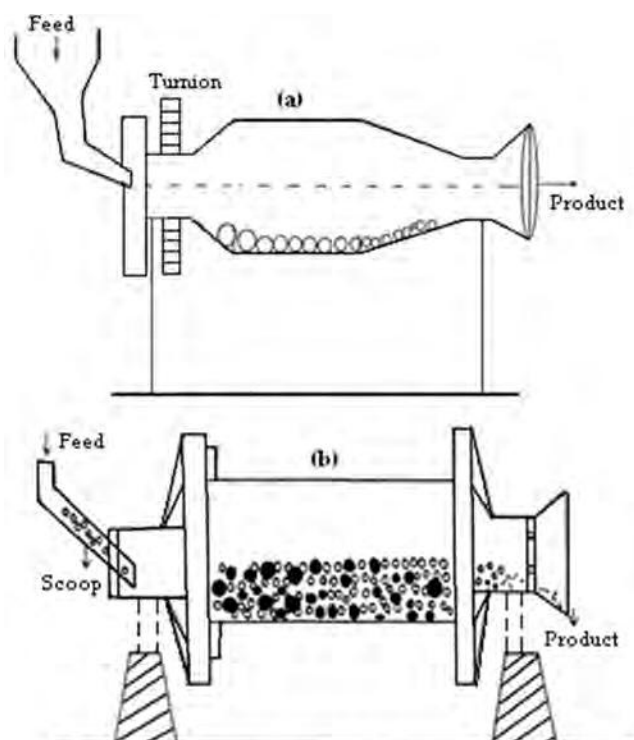

**Fig 2.12. Schematic view of Ball Mills; (a) Harding Mill
(b) Cylindrical Mill .**

2. Method of Discharge:

Cylindrical mills are also classified according to the mode of product discharge taking place from the mill. According to the discharge method mills are classified as:

- a.* Peripheral discharge mill: Discharge of the ground product takes place through meshed cylindrical shell.
- b.* Grate mill: Discharge of the ground product takes place through a screen extending as a diaphragm across the full section of the mill at the discharge end.
- c.* Overflow mill: Discharge of the ground product takes place by free overflow from the axis of the mill.

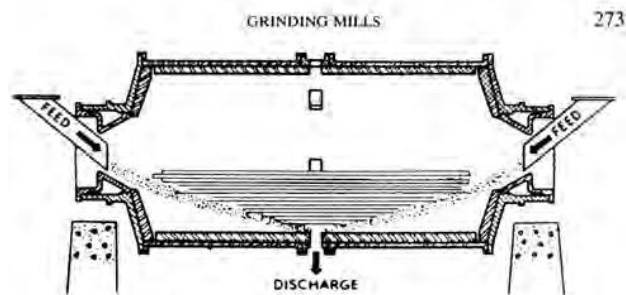

FIG. 7.16. Central peripheral discharge mill.

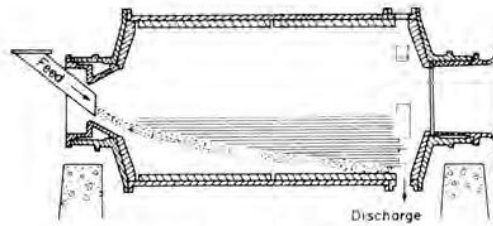

FIG. 7.17. End peripheral discharge mill.

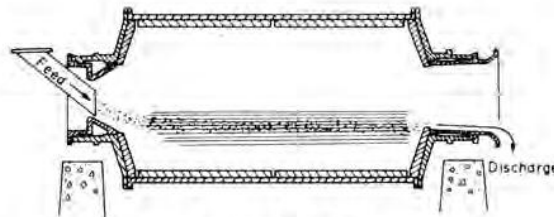

FIG. 7.18. Overflow mill.

Mechanical construction of a Cylindrical Ball mill:

Ball mill has few important components as follows:

1. Cylindrical shell.
2. Inner surface or liners.
3. Balls or grinding media.
4. Drive.

1. Cylindrical Shell:

It is the rotating hollow cylinder partially filled with the balls. The ore to be crushed is fed through the hollow turnnion at one end & the product is discharged through a similar turnnion at the other end. The material of construction for this hollow shell is usually high strength steel. The shell axis is either horizontal or at a small angle to the base. Large ball mills have a length of 4 - 4.25 mts, diameter of 3mts. They use hardened steel balls of size varying between 25-125 *mm*.

2. Inner Surface or Liners:

As the grinding process involves impact and attrition the interior of the ball mills is lined with replaceable wear resisting liners. The liners are usually high manganese alloy steels, stones or rubber. Least wear takes place on rubber lined interior. As the coefficient of friction between balls and steel liner is specifically large, the balls are carried up taken to a higher height along the inner wall of the shell and dropped down onto the ore with a larger impact force resulting in a better grinding.

3. Balls (Grinding Media):

The balls are usually *cast steel* unless otherwise stated. In some cases *flint* balls may be used. The diameter of the grinding media varies from 1-5inches. The optimum size of the ball is proportional to the square root of the feed size. The ball and liner wear are usually in the range of 450 – 1250 and 0.50 - 250 grams per ton of ore ground.

4. Drive:

The mill is rotated by electric motors connected through reduction gear box - ring gear arrangement.

Theory of Ball Mill Operation:

Ball mills may be continuous or batch type in which grinding media and the ore to be ground are rotated around the axis of the mill. Due to the friction between the liners–balls & liners–ore lumps, both the ore and balls are carried up along the inner wall of the shell nearly to the top from where the grinding media fall down on the ore particles below creating a heavy impact on them. This usually happens at the toe of the ball mill.

The energy expended in the lifting up the grinding media is thus utilized in reducing the size of the particles as the rotation of the mill is continued. In fact the grinding process is attributed to three different stages of ball mill working. They are:

- a. Cascading (attrition between the balls and particles).
- b. Cataracting (impact of the ball on the particles).
- c. Centrifuging.

All these stages of working are shown schematically in the figure 2.13below.

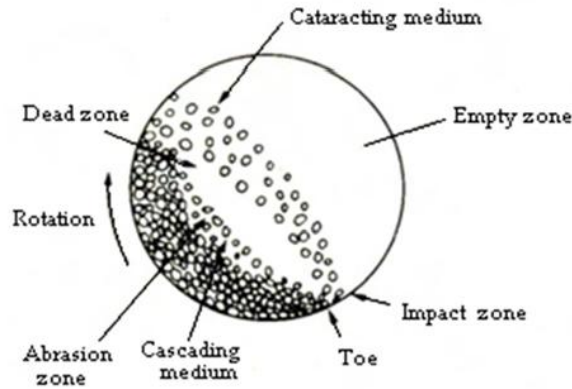

Fig.2.13. Different Stages and Zones of a Ball Mill.

Effective grinding depends on the rotational speed of the mill. If the mill operates at a low speed balls will be carried up along the inner wall to a certain height, but not large enough to give an impact force. Rather, they roll over each other or slip over. This type of operational condition is known as cascading of the mill. Even then some grinding is performed due to attrition. If the speed is raised, the balls start moving up further along the inner wall and suddenly fall from a greater height imparting an impact force at the toe of the mill. This impact is largely responsible for most of the grinding (Fig 2). This condition is known as cataracting. If the speed of rotation becomes too high, the balls are carried over and over again all along the inner lining as if they are sticking to the inner wall and there is hardly any grinding. This condition is known as centrifuging of the mill. If the speed of the ball mill is too low cataracting does not occur. Rolling down of balls and particles lead to particle rubbing and limited grinding only is possible. At the other extreme, that is at very high speed the mill, centrifuging occurs leading to little or no grinding. So mill is to be operated between these two extreme speeds.

Critical Speed of the Ball Mill:

The minimum rotational speed at which centrifuging occurs in a ball mill is defined as its critical speed. It has already been noticed that no grinding takes place in the ball mill when it centrifuges. So the operating speed of the mill should always be less than its critical speed enabling the media to deliver impacts at the toe or knee of the mill to result in grinding. The *critical speed* of a ball mill is of immense practical importance with regards to its efficient working.

Determination of Critical Speed of a Ball Mill:

Assumptions:

1. Let the radius of the cylindrical ball mill be, R .
2. Only single sized media of radius r is used in the mill.

During the rotation of the mill the grinding media is carried up along the inner wall of the mill shell. At any particular instant the forces working on the media is shown schematically in the figure2.14.

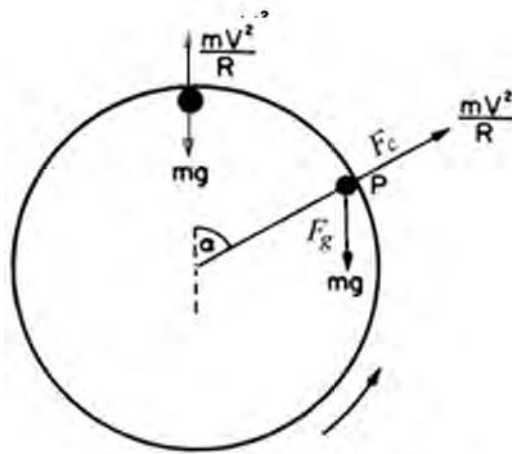

Fig.2.14. Forces Working on the Grinding Media .

Different forces working are:

1. A centrifugal force F_c working radially away from the centre of mill.
2. The gravitational force F_g acting vertically downward from the centre of the particle as shown in the figure2.14.

The speed at which the outer most balls may lose contact with the inner wall of the mill depends on the balance between *gravitational & centrifugal forces*.

Mathematically:

$$\text{Centrifugal force, } F_c = \frac{mv^2}{(R-r)} \text{ ----- (1)}$$

Where, $(R-r)$ is the radius of rotation, gravitational force, $F_g = mg \cos \theta$, g is the acceleration due to gravity and θ is the angle the particle at the centre of the mill.

Let v , be the linear speed of the cylindrical shell at the periphery.

Converting the linear speed to rotational speed of the ball mill we have:

$v = [2\pi (R-r)N]$, where, N is the rotational speed of the mill. The media will ride up to a point along the inner wall of the mill as long as the centrifugal force is greater than the gravitational force working on the ball. At any point if equilibrium is established, we have:

$$mg \cos \theta = \frac{mv^2}{(R-r)}$$

$$\Rightarrow mg \cos \theta = \frac{m[2\pi (R-r)N]^2}{(R-r)} = \frac{m[4\pi^2 (R-r)^2 N^2]}{(R-r)}$$

$$\Rightarrow g \cos \theta = 4\pi^2 (R-r)N^2$$

For centrifuging condition, the media has to reach the topmost position as shown in the figure 2.14 and then roll down to the other side without losing contact with the inner wall of the mill. Hence under the critical condition of centrifuging the media should at least reach the top most position. The speed at which this just happens is known as the critical speed N_c of the ball mill. To achieve such a condition, θ has to be 0° .

$$\text{Now, } N_{\text{critical}} = \frac{g}{4\pi^2 (R-r)}$$

$$\Rightarrow N_c = \frac{1}{2\pi} \sqrt{\frac{g}{(R-r)}} \text{ is known as the } \textit{critical speed} \text{ of the mill.}$$

In different units the critical speed of the ball mill can have values as follows:

$$N_c = \frac{42.3}{\sqrt{D-d}}, D \text{ \& } d \text{ expressed in meter. ----- (1)}$$

$$N_c = \frac{76.65}{\sqrt{D-d}} D \text{ \& } d \text{ expressed in feet. ----- (2)}$$

Usually the ball mill is rotated at 65-80% of the theoretical critical speed. The lower value is for wet grinding while the higher value is opted for dry grinding.

Characteristics of Ball Mill Working:

1. Speed and Energy Input Interrelation in Ball Mill:

Speed of the ball mill should be as high as possible without centrifuging. Initially the work input increases steadily as the speed of the mill increases. It reaches a peak at a particular speed and there after the work input decreases rapidly with the increase in speed. This is shown schematically in the figure 2.15.

2. Ball Load:

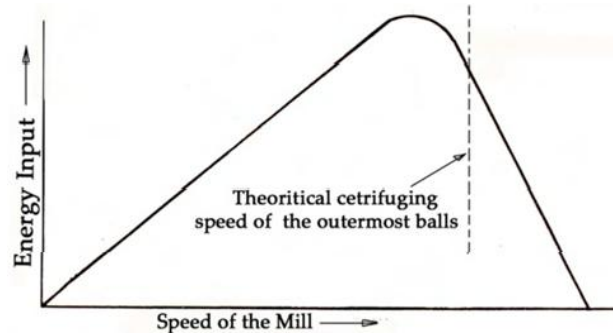

Fig. --- Relation between Speed and Energy Input

It is defined as the volume that is occupied by the grinding media out of the total volume of the ball mill without ore or water in it. The ball load should be such that it is slightly more than 30% of the total volume of the ball mill. During general operation media occupy between 30-50% of the volume of the mill. When a mill is operated for the first the time, balls of various sizes rather than single size are charged into the shell. The Justification for the use of the various sizes is obvious. If balls of definite size are charged, the *interstitial pores* created by the uniform sized spheres will work as void spaces and ore particles of that particular void size if caught in the void will not be crushed further. So as to avoid such problems balls of various sizes are used in the mill when it is installed and operated for the first time. During grinding the balls themselves get worn-off which reduces the ball load. The reduced ball load is replenished at regular intervals with new ball(s) of largest size only. In fact the larger balls crush the feed material more effectively while the smaller ones are responsible for producing fines.

The energy that the mill is made to consume is a function of speed of the ball mill, ball load, specific gravity of the ore and dilution of the pulp. With the increase in ball load the energy input into the mill is increased gradually but not in direct proportion to the ball load till a maximum is reached. Thereafter the energy input decreases gradually to zero as it had increased earlier.

This is due to the fact that, as the ball load is increased, the centre of gravity of the load comes nearer and nearer to the axis of rotation of the mill which decreases the energy input to the mill. A pulp density of 60 - 75% solids results in maximum energy input. The energy input versus the ball load is shown schematically in the figure 2.16.

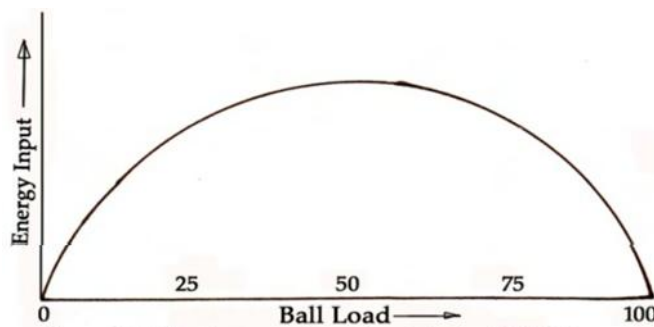

Fig. --- Ball load versus Energy input in the Ball Mill.

3. Reduction Ratio:

The reduction ratio that can be obtained in the ball mill is large compared to reduction ratios obtained in primary or secondary crushers. It may range from 50 -100 for a ball mill-classifier circuit. If the *r.r.* is high along with large capacity, it will be more economical to use ball mills in series. The first in the series may be with *r.r.* of 20 while the last one may be a fine grinder having *r.r.* of 5 resulting in an effective *r.r.* of $20 \times 5 = 100$.

4. Capacity:

The capacity the ball mill depends upon its size, hardness of the ore and the reduction ratio attempted. Ball mills yield 1-50 ton / hr of ore fines with 90% passing through 200 # screen.

5. Energy consumption:

Average energy input into the ball mill is around 16 kWh / ton of ore ground.

Factors affecting the size of the Product in a Ball Mill:

1. Rate of feed:

Higher the rate of feed lesser is the size reduction since the residence time of the ore particles in the mill is reduced.

2. Properties of the feed ore:

Under given operating conditions larger the feed larger will be the product. A lower reduction ratio (*r.r.*) is obtained with a hard material.

3. Weight of the ball:

Heavier balls produce finer product. Since the optimum condition is 50% ball load by volume, the weight of the balls is normally altered by the use of materials of different specific gravities.

4. Diameter of the ball:

Smaller balls facilitate the production of finer material but they are not effective in grinding larger sized particles in the feed. The limiting size reduction obtained with a given size of balls is known as *free grinding*. As far as possible smaller size balls are to be used.

5. Slope of the mill:

Increase in the slope of the mill increases its capacity of the mill. But a coarser product is obtained as the retention time of the feed in the mill is reduced due to higher slope.

6. Discharge freedom:

Increasing the freedom of discharge of the product has the same effect as that of increasing the slope.

7. Speed of rotation:

The mill should be operated at speed less than N_c . Usually it is operated at a speed, $N_{operational} = 0.65 - 0.75 N_c$

8. Level of Material in the Mill:

Power consumption is reduced by maintaining a low level of material in the mill. If the level is increased the cushioning action is increased and energy is wasted in producing excessive fines. Total level of material in the mill should be 50% maximum out of which at least 30% should be the ball load.

Advantages of the Ball Mill:

1. The mill can be used both for wet and dry grinding.
2. The cost of installation of a ball mill is low.
3. The ball mill can use an inert atmosphere to grind explosive materials.
4. Media used for grinding is relatively cheap.

5. The mill is suitable for grinding materials with any degree of hardness.
6. It can be operated in batches or continuously.
7. It is used for both open and closed circuit grinding effectively.

Dry & Wet Grinding

It is to be noted that ball mills can be operated dry or wet. Mills are usually employed to grind ore in wet condition. But for some specific purpose essentially in chemical industries dry grinding is employed.

During dry grinding the mills are connected with pneumatic classifiers in closed circuit to produce extremely fine powder. Pulverized coal is obtained in this manner.

Advantages of Wet Grinding Over Dry Grinding:

Though wet grinding is generally applicable in low speed mills there are number of advantages of wet grinding over dry grinding:

1. Wet grinding facilitates better removal of the product, eliminates dust problem, lessens the noise and heat produced though the wear may actually increase by 20 %.
2. Power consumption is lowered by 10-30% over dry grinding per ton of product.
3. The capacity increases per unit volume of the mill.
4. This grinding makes wet screening possible for producing materials in narrow size range.
5. Dust problem is eliminated.
6. Wet grinding makes handling & transportation of product easier.
7. Sticky solids are more easily handled.

Hardinge Mill Or Cylindro-Conical Mill:

The Hardinge mill consists of two conical sections connected by a central cylindrical section. The mill is supported by the end bearings on which the hollow turnnions are mounted. The mill is made to rotate by gear - pinion arrangement. Feed enters through the left side 60° cone to the primary grinding zone where the diameter of mill is highest.

Product pours out as a continuous stream of thick pulp through the right side 30° cone. It is said that conical sections compel the coarse particles and the larger balls to seek the cylindrical section of larger diameter while fine particles & smaller balls are found in the smaller diameter conical section to the left. As the mill is rotated the larger balls move towards the point of maximum diameter or feed end while the smaller balls migrate towards the smaller diameter or discharge end. So from

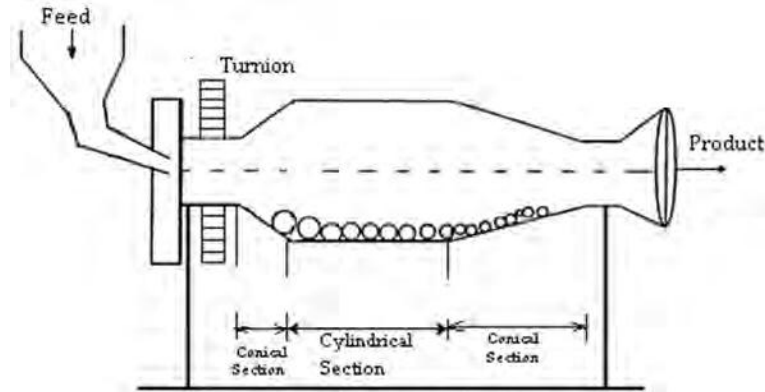

Fig.2.17. Schematic Diagram of a Hardinge Mill.

constructional point of view preferential grinding of coarse particles is performed by the large balls & fine grinding is performed by the smaller balls. The Hardinge mill is shown schematically in the figure.

Hardinge mills are widely used in metallurgical plants and are usually adopted for wet grinding. Dry grinding of coal, pulverization of lime stone, clay & cement clinker is possible in this mill. This mill operates continuously. This type of mill is shown schematically in the figure.. This mill can be further classified according to the freedom of discharge employed as discussed earlier.

Laws of Crushing:

The first step in ore beneficiation is to reduce the size of the ore by crushing & grinding, commonly referred as comminution. The main objective of comminution is to liberate the mineral particle from the unwanted gangue. This is achieved by detaching the mineral particle from the gangue. For different degree of liberation different types of crushing equipments are used. Though crushing and grinding equipments have been developed to a high degree of perfection and automation, not much change has been made in the theory of crushing or grinding. The design of equipments for size reduction largely depends on experience and empirical relationships. The most important consideration in any size reduction is the energy it consumes in performing the activity, as energy is costly. *The empirical relations between the energy consumption and size reduction are termed as laws of crushing.*

Rittinger was the first one to propose such a law termed as Rittinger law which was subsequently modified further by Kick and Bond. Presently we have three laws of crushing.

1. Rittinger Law:

Rittinger stated that, "Energy expended during comminution is

proportional to the new surface area created as a result of particle fragmentation”. Mathematically, the statement can be represented as:

$$E = K_r (S_2 - S_1),$$

Where, K_r is called Rittinger’s constant or work index and S_2 & S_1 are the final & initial specific surface areas respectively. In terms of particle diameter it

becomes: $E = K_r \left(\frac{1}{d_2} - \frac{1}{d_1} \right),$

Where, d_2 & d_1 are final & initial diameters of the particle respectively. Rittinger’s law applies fairly well in the fine grinding range of 10-1000 m in size. Rittinger’s law is quite accurate in calculating the energy consumed during fine crushing.

2. Kick Law:

According to Kick’s law of crushing,” The energy consumed during size reduction is directly proportional to the logarithm of size reduction ratio ($r.r$)”. If d_2 & d_1 are the final & initial diameters of the particle during size reduction the reduction ratio($r.r$) is d_1/d_2 . Then energy consumed in size reduction is proportional to $\log(d_1 / d_2)$.

Mathematically this can be expressed as:

$$E = K_k \log(d_1 / d_2), \text{ where } K_k \text{ is the Kick's law constant.}$$

Rittinger's law is most successful in the range of fine grinding while Kick's law is successful in predicting the energy consumption during coarse crushing that is in the range of 1cm and above. Neither of the above laws predicts the energy consumption in the intermediate range of size reduction taking place in cone crusher or crushing rolls, a third law has been proposed by Bond.

3. Bond Law:

It is stated as *“The total amount of work input represented by a given weight of crushed or ground product is inversely proportional to the square root of the product particle diameter”*.

As per the law:

$$W_b \propto 1 / \sqrt{D_p}$$

Where, D_p is the average size of the particle and W_b is the Bond's work input

Mathematically this law can be written as:

$$W_b = 10 W_i \left[\frac{1}{\sqrt{D_p}} - \frac{1}{\sqrt{D_f}} \right]$$

Where, D_p and D_f are the average size of the product & feed respectively and W_i is the Bond' work index an intrinsic property of the material being crushed. Work index is the comminution parameter that expresses the resistance of the material to crushing and grinding. Numerically it is equal to the work input in kWh/ton that is required to reduce a material from an infinitely large sized feed to a product 80% of which passes through the screen of $100 \mu m$ aperture size.

Criteria of Selecting Comminution Equipment:

The choice of machine for a given crushing operation will be affected by the following factors:

1. Size of the product required (coarse, intermediate or very fine) along with the size of the feed.
2. Quantity of the material to be handled (input/output capacity).
3. Physical properties of feed material to be crushed. Irrespective of the feed and product sizes, the physical properties of the material under consideration are of primary importance in selecting suitable crushing equipment. Hence it is imperative here to discuss regarding the physical properties of the material in more detail.

Significant Physical Properties of Feed Ore:

1. Hardness:

Hardness of the mineral affects the power consumption and wear of the machine. For hard and abrasive minerals low speed machines developing high compressive stresses are preferred.

2. Structure:

Normal granular minerals like coal, ores and rocks can be effectively crushed employing normal compressive and impact forces. With fibrous minerals it is necessary to effect tearing action for size reduction. Hence knife edge mills are widely used for asbestos and mica like minerals.

3. Moisture Content:

It is found that minerals with higher moisture content (5-50%) do not flow efficiently. Under such conditions they tend to clog the crusher. Wet grinding can be carried out satisfactorily on these minerals.

4. Crushing strength:

The power required for crushing is almost directly proportional to the crushing strength of the minerals.

5. Friability:

The friability of the mineral is its tendency to fracture during normal handling. Crystalline minerals will break along well defined planes and power required for crushing of such minerals will increase as the product particle size is reduced.

6. Stickiness:

A sticky mineral will tend to clog the equipment so should be ground in a mill that can be readily cleaned.

7. Friction factor or Soapiness:

If the coefficient friction is low, usual crushing will be difficult. In such cases size reduction can be carried out by employing impact or shear forces.

8. Explosive mineral:

These mineral must be ground wet or in the presence of an inert atmosphere otherwise they may catch fire or explode.

9. Mineral producing heavy dust:

Dusts are harmful for health so should not be allowed to escape to the atmosphere. Special crushing methods are to be employed while crushing minerals producing heavy dust.

CHAPTER 3

PARTICLE SIZE DETERMINATION

Introduction:

Size analysis of various products of a crushing mill constitutes a fundamental part of the laboratory testing procedure. It is of great practical importance to make a correlation between the particle size and degree of liberation. Further it is to be understood that, particle size has a great role to play during reactions between solid - liquid or solid-gas. Most of our extractive processes, such as calcination, roasting, reduction, oxidation and leaching involve a solid and a gas or liquid phase. As the processes are diffusion control, the particle size plays a very important role during different *unit processes*. Rapid and efficient working of roasters, smelters, froth flotation cells & leaching tanks largely depends on the size of the beneficiated ore. So the product from the crushing equipment is to be analysed for its size for all practical purposes. Further the size analysis of the product is required to evaluate the energy consumption and the size reduction process it may require for further size reduction.

Particle Size & Shape:

The primary function of precise particle analysis is to obtain quantitative data about size and size distribution of the particles in the product material. The shape of the particle plays an important role in the size determination. The size of a spherical particle can be defined uniquely by its diameter. However, there is no unique dimension by which the size of an irregular particle can be described. The term most often used to describe an irregular particle is the equivalent diameter (\bar{d}). There can be various shapes to describe a particle as discussed below:

1. Accicular: Needle like particles.
2. Angular: Sharp edged polyhedrons.
3. Crystalline: Particles of regular geometric shapes.
4. Fibrous: Regular or irregular thread like particles.
5. Dendritic: Particles having branched crystalline structure.
6. Flaky: Plate like particles.
7. Granular: Equidimensional irregular shaped particles.
8. Irregular: Lack of any symmetry in the particles.
9. Nodular: Particles having rounded irregular shape.
10. Spherical: Globular particles.

Particle Size:

The crushed ore particles are generally irregular in shape and it is quite difficult to define the size of the particle uniquely. In case of spherical particles, the diameter is the size. For cubes the edges, the long diameter or diameter of a sphere of equal volume may be considered as the size. But for totally irregular particles there is no such standard method. So it is impossible to define what is meant by size of the particle.

Common Methods of Size Analysis:

Particle size is usually defined as the narrowest regular aperture through which mineral particle passes through. Through this definition is applicable to polyhedrons it is not valid for rod shaped narrow particles. Particle size can be determined by various methods as described below in table

Methods of Particle size Determination:

Methods	Approximate size range (microns) ($1 \mu m = 10^{-6} m$)
Sieve analysis	100000 -10
Elutriation	40 – 5.0
Optical microscopy	50 – 0.25
Sedimentation(gravity)	40 – 1.0
Sedimentation(centrifugal)	5 – 0.05
Electron microscopy	1 – 0.005

L. Microscopic Measurement:

For measuring the particle size under microscope, it is customary to sprinkle them on a slide and to measure their diameter in random directions or in any two perpendicular axes within the plane of vision. In both the cases the smallest dimension is neglected. For number of particles the dimension x_i is measured and tabulated as follows:

Number of observations	x_i
1	x_1
2	x_2
$n-1$	x_{n-1}
N	x_n

Now average size, $\bar{x} = \frac{x_1+x_2+x_3+\dots+x_{n-1}+x_n}{n}$

2. Elutriation:

Elutriation is based on the fact that a particle will just be sustained in an upward rising current of water or any other fluid if the velocity of the water current is equal to that which the particle would attain when falling in still water. This works on the principle of Stoke's law of settling.

3. Sieve Analysis:

This is the most important method of sizing the mineral particles. This is widely used to determine the efficiency of size reduction operations and also used as a yardstick for assessing the fineness of a ground product. As sieve analysis has been the most important method of size analysis it has become pertinent to discuss about the standard screens or sieves used worldwide for the purpose.

Tyler Series and ASTM Standard Screens:

Tyler mathematical series is the most widely used for manufacturing ASTM standard screens for sieve analysis. The screens are made-up of bronze brass or stainless steel wires woven into a screen cloth having square openings.

In case of ASTM standard screens, the screen opening area of each successive screen is either double or half the area of the next screen in the series. This implies that the aperture size varies with a factor $\sqrt{2}$.

The 200# screen has an opening of $74\mu\text{m}$ and the lowest screen opening available in this series is $37\mu\text{m}$. This is because below this opening fabrication of screens becomes very difficult. But there is no upper limit to the screen opening size. The 200 # sieve ($74\mu\text{m}$) is chosen as the reference screen in the ASTM standard sieve series and relates both ASTM and British standard screens. In the ASTM standardization, mesh number ranges from 3- 400.

Sieve or Screen Analysis:

Screen analysis is the experimental method to determine the average size of the crushed product. The product from jaw gyratory or any other crusher is hardly uniform in size. In fact the product consists of particles of various sizes and it is impossible & impractical to know the size of each product particle. Hence, an average size of the product is determined by sieve analysis method as it proves to be the quickest and most reliable method.

Average Size Determination for Large Sized Particles:

- 1.** For large sized particles having a diameter of few centimeters, it is better to know the size of each particle and then average them out for calculating an average size. A sample is taken from the bulk by coning and quartering technique and the sample may consist of 10, 20 or 100 particles.
- 2.** Measure-out the dimensions of each particle in three perpendicular directions to reflect dimensions in the three co-ordinates (x , y and z).
- 3.** The data recorded for each particle is made into a table as shown below:

Particle Number	Dimension			
	x_i	y_i	z_i	\overline{d}_i
1	x_1	y_1	z_1	\overline{d}_1
2	x_2	y_2	z_2	\overline{d}_2
3	x_3	y_3	z_3	\overline{d}_3
4	x_4	y_4	z_4	\overline{d}_4
-	-	-	-	-
-	-	-	-	-
10	x_{10}	y_{10}	z_{10}	\overline{d}_{10}

4. Then find out the maximum and minimum d value from the table.

If, $d_{\max} / d_{\min} < 1.5$, use arithmetic, geometric or harmonic mean methods to find out the average size of the product as illustrated below.

a. Arithmetic mean diameter, $\overline{d} = \frac{\overline{d}_1 + \overline{d}_2 + \overline{d}_3 + \dots + \overline{d}_{10}}{10}$

b. Geometric mean diameter, $d = \sqrt[n]{d_1 \times d_2 \times d_3 \dots \times d_n}$.

c. Harmonic mean diameter, $\frac{1}{d} = \frac{1}{d_1} + \frac{1}{d_2} + \frac{1}{d_3} + \dots + \frac{1}{d_n}$.

5. If, $d_{\max} / d_{\min} > 1.5$ following methods are usually employed to calculate the average size of the product:

a. In terms of specific surface area: $d_{\text{mean}} = \bar{d} = \frac{\sum n_i d_i^3}{\sum n_i d_i^2}$,

n_i is the number of particles under consideration and d_i is the diameter of the particles.

b. In terms of total weight (w) : $d_{\text{mean}} = \bar{d} = \frac{\sum w_i}{\sum (w_i/d_i)}$,

w_i is the individual weight of each particle with diameter d_i . Usually in laboratory sieve analysis technique we use the second formula to evaluate the average size of the product. This can also be used for finer product in the same d_{\max} / d_{\min} ratio where w_i represents the weight fraction of the material with average diameter d_i .

Average Size Determination by Sieve Analysis:

Product sample of certain weight is taken along with standard sieves. The screens are arranged in the order of increasing mesh nos. from top to bottom with a pan at the bottom. The feed is kept in the top sieve, After closing the top screen, the entire set is kept in the sieve shaker machine and. the product is allowed to be shaken for 15 minutes and then removed. Basic method of representing analysis data and typical analysis data are presented in the table .

Representation of Sieve Analysis Data:

Mesh No.	Mesh opening D_i (in mm)	Weight % retained w_i in gms.	Cumulative weight % retained C_i .
8	1.651	-	-
10	2.350	w_1	$\frac{w_1}{W} \times 100$
14	1.651	w_2	$\frac{w_1 + w_2}{W} \times 100$
20	1.168	w_3	$\frac{w_1 + w_2 + w_3}{W} \times 100$
28	0.833	-	-----
35	0.417	-	-----
48	0.295	-	-----
Pan	0.000	$w = \sum w_i$	$\frac{\sum w_i}{W} \times 100$

Example:

Let us imagine 10, 14, 20, 28# screens are used in sieve analysis. Let the weights retained on the consecutive screens be w_1, w_2, w_3 & w_4 respectively. So the cumulative weight retained on 14# screen is: $w_1 + w_2$.

Similarly the cumulative weight retained on 28# screen is: $w_1 + w_2 + w_3 + w_4$.
 Now the cumulative weight percent can be calculated out by taking the total sample weight used in the screen analysis process. A plot of cumulative weight percent passing or retained against the aperture size is drawn as shown in the figure .

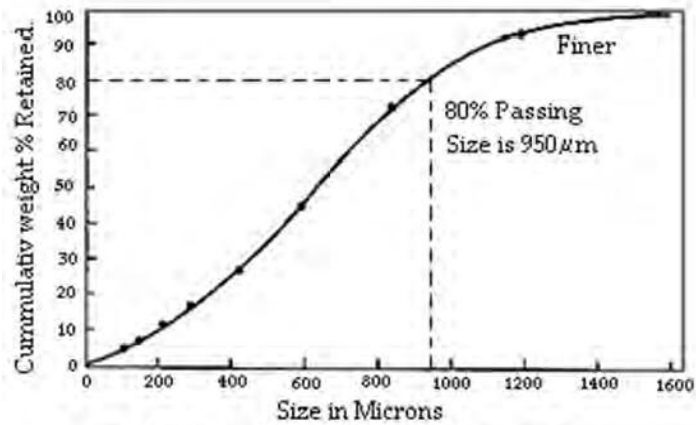

Fig 3.1. Cummulative Charting of Size analysis.

A quick & easy method of determining the average size of the product from the screen analysis is the 80% passing size which is indicated in the plot 3.1. The eight percent (80%) passing size is accepted as the standard size of the crushed product universally unless otherwise stated. The standard condition may be changed as per the requirement and is to be specified by the buyer which may be 70 or 90% passing. This % passing means that at least that percent of the material would pass through on the specified sieve when screened. This kind of plots is most commonly used in mineral industries.

Screen Analysis Equipment:

For sieve analysis, screening is usually carried out in a mechanised sieve shaker called Ro-tap sieve shaker.

Ro-Tap Sieve Shaker:

Figure3.2.shows the Ro-tap machine schematically. It consists of a movable cage with a base *a* and a top plate *b* between which 13 half height or 7 full height sieves with pan and cover lid can be mounted.

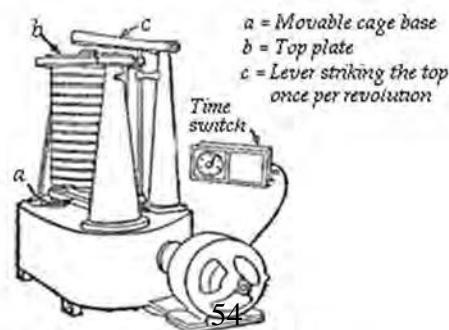

Fig 3.2. Rotap Sieve Shaker

The mounted sieves are subjected to rotary shifting motion while at the same time the lever *c* strikes the top plate once per revolution. This striking vibrates the screen cloth for better screening. A timer switch with the motor is used to control the time duration of screening. The machine is so designed that it performs the most ideal screening operation within the specified time period.

CHAPTER 4

INDUSTRIAL SCREENING

Introduction:

By this time it has been clear that the screening of the crushed product is quite important in a large scale. Screening segregates the bulk of the crushed product into few fractions. This segregation is beneficial in many ways as follows:

- a.* Properly sized or the required sized material is charged into the next comminution equipments for further size reduction. Proper feed size reduces the overloading on the subsequent size reduction machines and increases the overall efficiency of the comminution.
- b.* Properly sized material can be charged into the process reactors such as smelters, roasters or calcinators making the process more efficient.

Till now screening has only been discussed on a laboratory scale but for industrial need, the screening has to be carried out in a much larger scale. Thus large scale screening is termed as *industrial screening* which differs from the laboratory screening practices in many ways. It is important to know the methods those are available and also the factors which affect the process of industrial screening.

Purposes of Screening:

1. To prevent the entry of undersized material to the crushing machines so as to increase the capacity and efficiency of comminution.
2. To prevent oversized material from passing to the next stage in closed circuit crushing or grinding.
3. To prepare closely sized feed for next stage of unit operation such as gravity concentration.
4. To prepare closely sized end product as per specification and requirement.

Mechanism of Screening:

When a crushed product is kept on a screen something would pass through & something would be retained on it. The material passing through screen openings is known as under flow or under sized while the material retained is known as over flow or over sized. So the basic fact attached to screening is the passage of under sized material through the screen. There are several factors affecting this passage. The factors are:

1. The absolute size of the screen openings.
2. The relative size of the particle to that of the screen aperture.
3. The percentage of open area available on the screening surface.
4. The angle at which particle strikes the screening surface.
5. The speed with which the particle strikes the screening surface.
6. The moisture content of the material to be screened.
7. The opportunity offered to each particle to hit the screening surface that is the probability that a particle will hit the screening surface before it is taken away by overflow.

Effect of Screen Opening Size:

The passage of undersized particles through each opening is inversely proportional to the screen aperture. This leads to the fundamental conclusion that the other conditions remaining unchanged the capacity of a screen given in *tons per hour per sq. foot per millimeter screen aperture* increases with increase in screen opening size.

Effect of Relative Particle Size:

The relative size of the particle and the aperture size control the passage of the particles through the screen. Larger sized particles with larger aperture get screened easily as compared to smaller sized particles on finer screens.

Percentage of Open Area on the Total Screening Surface:

If the total surface area is one square meter and there are only few openings on it then the quantity of screened material will also be quite less.

If large numbers of openings are available on the same screen area, automatically quantity screened would go up. However there is always a limit to the extent of open area which can be available per unit surface area of the screen. This is due to the fact that the screens are made up of materials such as rods, wires & etc having definite dimensions. These dimensions depend strongly on the load that the screen is going to bear during screening operation. The dimensions of the wire or rod increase with an increase in aperture size so as to have better strength.

Angle at Which the Particle Strikes Screening Surface:

The crushed particles are always irregular in size and shape. Hence, the angle at which the particles hit the screen surface is extremely important. A rod like particle gets through an aperture which is little above its diameter if the particle hits the screen surface with its long axis perpendicular to the screen surface. However, the same particle will not be able to pass through a screen of larger aperture when the particle hits the screen surface with its long axis parallel to the screen surface. Most efficient results are obtained, when the particles hit the screen surface at angle in the range of $45 - 60^\circ$.

Speed at which the Particles Strike the Screen Surface:

Speed of movements of the particle over the screen surface is also an important factor in controlling the extent of screening. It is important to note that effective screening is zero when the speed of the particle is zero on the screen surface. With an increase in particle speeds the effectiveness of the screen increases. However, if the speed is excessively high the particle passes off to the overflow before it gets a chance to pass through any particular aperture of the screen. This implies that the particle gets very little scope to pass through the sieve. Further the particle movement during screening is also quite important as it reduces the effect of oversized particles trying to blind the screen. If the screen does not vibrate properly it may be clogged completely by the oversized particles in the product and thereafter no screening would take place. For effective screening, both vibratory and circular motions are usually employed simultaneously.

Effect of Moisture in the Feed:

When little moisture is present in the feed material to be screened, the screening efficiency gets reduced enormously.

In fact, it becomes impossible to screen them effectively. The difficulty is due to the fact that, moisture tries to bind few smaller particles into larger aggregates and such aggregates are large enough to pass through the smaller screen opening. It is found that either totally dry or wet pulps can be screened with relative easiness.

Probability Effect:

It is of utmost importance that each particle is given an opportunity to strike the screen surface so as to get screened or to pass-off to the overflow. If

the particle is given 2, 5 or 8 chances of striking the screen surface, it can always be qualitatively pointed out that probability of screening is increased when more and number chances are given to the particles to interact with the screen surface.

Screening Surfaces:

Screening surfaces are the surfaces through which screening takes place. Screening surfaces are categorised according to the mode of their manufacturing classified as follows:

Parallel Rods:

Such a surface is usually made-up-of steel bars, rails, channels and etc. It can also be made from wood and bamboo.

Punched Plates:

The surfaces are punched steel sheets or plates of various patterns. The openings are normally circular, rectangular, hexagonal and slot like.

Woven Wires:

The screening surfaces are woven carefully by gauged wires. These wires are generally made up of steel, bronze, copper & monels. The screen surfaces are shown schematically in the figure.

Types of Screens:

The screens are classified as:

1. Stationary.
2. Moving.

Stationary screens:

These screens are of limited use but are not totally obsolete. These screens are grizzlies. They consist of parallel rods, bars or woven wire mesh set at an angle to the ground. They have heavy screening surfaces. The bars are usually held together at right angles to their length and are spaced at the desired distance sleeves on the bolts. They are usually employed in case of coarse crushing. A slope is generally provided so that the material fed onto the screen surface would roll down facilitating better screening. A typical stationary grizzly is shown in the figure 4.2. The major disadvantage of this type of screen is *clogging*. Rails are used under severe service conditions with openings greater than five (5) inches.

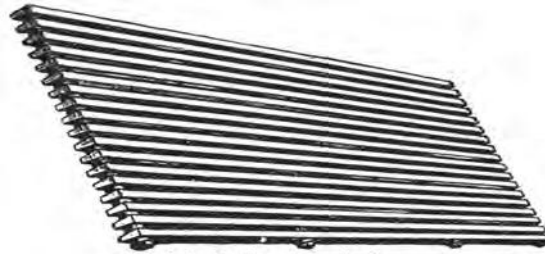

Fig.4.2. Stationary grizzly.

Moving Screens

1. Moving grizzlies.
2. Trommels or Revolving screens.
3. Shaking screens.
4. Vibrating screens.

Moving Grizzlies:

The grizzly is made up of rods and bars but have movements as compared to stationary grizzly.

In moving grizzlies alternate bars or rods alternatively rise and subside, so that the feed material move forward gently with sufficient turning over. There are different grizzlies such as:

- a. Moving-bar grizzly.
- b. Chain grizzly.
- c. Travelling grizzly.
- d. Disc or Roller type grizzly.
- e. Vibrating grizzly.
- f. Shaking grizzly.

Advantages of Grizzlies

- a. Low floor space is required for installation.
- b. They act as feeders to intermediate crushers.
- c. Result in better screening than stationary screens.

Trommels or Revolving Screens:

Revolving screens or Trommels have been used more widely than any other type of movable screens but recently they have been replaced by vibrating screens. Trommel consists of rotating cylindrical, prismatic, conical or pyramidal shells of punched plates or thick woven wires. A trommel has one or more shells which are arranged in a concentric manner. When the trommel has only one shell, it is known as simple trommel. With more than one shell it is known as compound trommel. In case of compound trommels screen opening aperture) gradually decrease from the innermost screen to outermost screen. The trommel is commonly 3 - 4ft in diameter and 5-10ft. in length. The Shells are driven by a central shaft attached to them by 4 or 6 armed spiders. The material to be screened is charged into the inner most shell and is made to flow out peripherally. When the trommel is rotated by the central shaft the material inside starts revolving and gets screened. The under sized material comes out of the trommel all along the periphery & oversized material comes out at the other end.

Central shaft of the trommel is made to inclined on the horizontal to facilitate automatic flow of the material from one end (feed end) to the other end (discharge end) due to force of gravity. Cylindrical trommels outnumber all other types of trommels. Figure shows a typical trommel schematically.

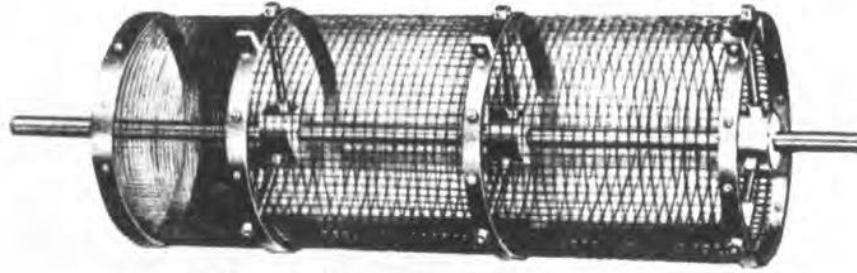

Fig.4.3. Schematic figure of a trommel.

Compound Trommels:

Compound trommels have two or more concentric screening surfaces on the same shaft. The coarsest is the inner most while the screen apertures reduce successively from inside to outside. They are used when several short-range products are desired from a single long-range feed and the floor space is limited. There may be conical and prismatic trommels but cylindrical is the most common one.

Advantages of Trommels:

1. It requires smaller floor space
2. It has a larger capacity per unit screening area.
3. It is cheap to operate.
4. Several fractions are obtained in one go.
5. Screening operation is quite efficient, can utilize both wet and dry screening.

Shaking Screens:

It essentially consists of a shallow rectangular box where the length is at last 2- 4 times the width. It is open at one end and is fitted a screen bottom.

It is shaken by means of a suitable mechanism. Speed, slope and length of the stroke should be adjusted to produce rapid stratification of the feed with a forward motion so that minimum blinding of the screen surface is resulted. It is widely used in case of screening of coal. It looks very similar to the vibrating screen.

Vibrating Screens:

Vibrating screens are recent development and have made most of the other screening practices obsolete. It is essentially a flat plane screening surface made from punched plates or wire woven which is secured rigidly on a steel frame. This frame is attached to certain mechanical device which imparts a reciprocating up and down motion to the screen in the direction either normal to the screen surface or at a high angle to the screen surface. These screens can be driven electrically or mechanically. The particles passing through the screen is the under flow and particles retained on it are discharged as overflow continuously at the other end.

Comparison between Shaking & Vibrating Screens:

1. Shaking screens have number of advantages over most of the vibrating screens in terms of cost of operation& installation.
2. Shaking screens can be set almost flat during operation.
3. But they are more prone to heavy wear and require more frequent and expensive repairs compared to vibrating screens.

Operating Characteristics of Screens:

The operating characteristics of any industrial screen are:

- a. Capacity.
- b. Efficiency or performance.
- c. Operating cost.

Capacity:

Capacity of the screen depends upon:

1. The area of the screening surface.
2. The size of the opening.
3. Characteristics of the ore such as specific gravity, moisture contents, temperature, proportion of fines particularly slime or clay in the product.
4. Type of screening mechanism used.

Capacity and efficiency are interrelated upto a particular extent. If the capacity is to be large, the efficiency has to be low. If the efficiency is to be improved capacity has to be sacrificed. Because of the direct dependence of screening capacity upon the area of screening surface and upon the screen aperture, it customary to express the capacity in the term of tons per square foot per millimeter screen aperture per 24 hours.

CHAPTER 5

MOVEMENT OF SOLIDS IN FLUIDS

Introduction:

The movement of solids in fluids plays an important role in various classification processes such as gravity concentration, heavy media separation, jigging, tabling, thickening and filtration. Hence it is extremely important to know how the solid particles behave in fluids.

Fluid Resistance & Terminal Velocity:

When a solid particle is immersed in a fluid as shown in the figure 5.1 it is acted upon by the following forces under the condition of rest:

1. Gravity force, $F_g = mg$
2. Buoyant force, $F_b = m'g$, which is equal to the weight of the fluid displaced by the solid body.

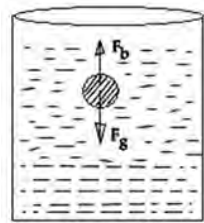

Forces acting on a Spherical particle; static condition.

The gravity force always acts downward while the buoyant force always acts upwards as shown in the figure. This is as per the classical Archimedes' principle. This is true as long as both the object and fluid are static or there is no relative motion between the particle and the fluid. Hence, the net force acting on the body under the condition of rest is:

$$F_n = F_g - F_b = mg - m'g .$$

If, $F_g > F_b$, the solid particle starts moving down in the fluid column and ultimately settles to the bottom of the vessel.

Similarly, If, $F_g < F_b$, the solid particle floats on the surface of the fluid.

Once there is downward movement of the particle relative to the fluid medium, the situation with regards to the forces acting on the particle changes and a new force, R starts acting on the particle in addition to F_g and F_b already acting on it. The new force is termed as the *fluid resistance or viscous force* on the particle settling in the fluid. This force always acts in a direction opposite to the direction of settling. These forces are shown schematically in the figure 5.2.

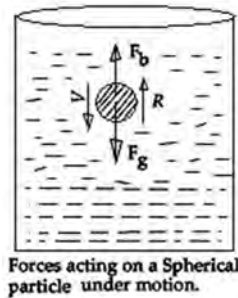

Under the condition of particle settling in the fluid, the net force that works on the particle:

$$F_n = F_g - F_b - R = mg - m g - 6\pi\mu rv$$

Where, $R = 6\pi\mu rv$.

Hence, as long as, $F_n > 0$, the particle would continue to accelerate down to settle. This suggests that the velocity of the particle will increase steadily starting from zero as it starts to settle. Logically, the settling velocity of the particle cannot increase indefinitely. This is due to the fact that, as velocity of the particle increases the fluid resistance force, $R = 6\pi\mu rv$ working on it also increases correspondingly. Hence, a situation would be arrived where the downward gravitational force would be exactly balanced by the fluid resistance force and the net force on the particle would be zero. Under this situation the particle would accelerate no more rather it would start settling down at a constant velocity till it reach the bottom of the fluid column. The constant velocity at which the particle settles in a fluid is termed as *terminal velocity* (v_t).

Determination of Terminal Velocity:

Let us consider the following parameters with regards to the settling of a spherical particle in a fluid (ref.fig.5.2.):

r = Radius of the spherical particle.

ρ_p = Specific gravity of the spherical particle.

ρ_f = Specific gravity of the fluid.

μ = Viscosity of the fluid.

g = Acceleration due to gravity (980cm/sec²).

Applying the second law motion to the falling sphere in a fluid we have:

$$F_n = F_g - F_b - R = mg - m'g - 6\pi\mu rV$$

(Q Mass \times Acceleration = Σ Forces)

The above equation takes the form:

$$m \frac{dv}{dt} = mg - m'g - R$$

$$\text{Or, } \frac{4}{3}\pi r^3 \rho_p \frac{dv}{dt} = \frac{4}{3}\pi r^3 (\rho_p - \rho_f)g - 6\pi\mu r v$$

(Q $\frac{4}{3}\pi r^3$ is the volume of the sphere).

Dividing both sides of the equation by $\frac{4}{3}\pi r^3 \rho_p$

$$\text{We have: } \frac{dv}{dt} = \left(\frac{\rho_p - \rho_f}{\rho_p} \right) g - \frac{9}{2\rho_p r^2} \mu v$$

The terminal velocity is achieved when the net force acting on the particle is zero. This statement implies:

$$m \frac{dv}{dt} = 0$$

Hence, $\frac{dv}{dt} = a = 0$, as mass of a particle cannot be zero.

$$\text{Now, } \frac{dv}{dt} = 0 = \left(\frac{\rho_p - \rho_f}{\rho_p} \right) g - \frac{9}{2\rho_p r^2} \mu v$$

$$\text{or, } \left(\frac{\rho_p - \rho_f}{\rho_p} \right) g = \frac{9}{2\rho_p r^2} \mu v$$

$$\text{or, } v_t = \frac{2r^2(\rho_p - \rho_f)g}{9\mu}$$

This equation is called *Stokes's law of settling or terminal velocity*,

Validity of Stoke's law:

Stokes law is highly theoretical in nature assumes the following parameters during its derivation. The assumptions are:

1. The particle settling in the fluid is completely spherical.
2. The container walls do not affect the settling of the particle.
3. The fluid does not interact with the particle either chemically or physically to affect its settling.
4. The presence of other particles does not affect the settling of the particle.

If the particle is settling under the above conditions then it is defined as *free settling*. Hence Stoke's law of settling is only valid for smaller sized particles within the laminar or viscous flow condition (the velocity of settling is low). Stokes law is accurately verified for spheres of quartz less than 50 microns in diameter. For higher velocities and larger particle sizes Stoke's law fails to predict the terminal velocities. The settling of particles under stokes's law condition is termed as *free settling*. For any other condition the settling is known as hindered settling.

General Principles of Free Settling:

1. Specific gravity:

Of the two particles of same size, having different specific gravity, the particle having higher specific gravity will settle faster.

2. Size:

Of the two particles of same specific gravity, the larger one will settle faster.

3. Shape:

Spherical particles settle faster than narrow, long and flat particles.

4. Specific gravity of the fluid:

In two different fluids of different specific gravities, the particle will settle faster in the lighter fluid.

Hindered Settling:

When many particles are present, there is a mutual interference in the motion of particles and the velocity of motion is considerably less than that is computed under free settling condition. Settling under such a condition is termed as *hindered settling*.

Newton's law of Settling:

Under Stoke's law, the conditions are highly ideal and practically not feasible.

For example, when a particle moves in the fluid, it is bound to create some turbulence and the following activities are bound to take place.

- a. There must be interparticle collision and mutual influences.
- b. There must be some effect of wall on the particle movement.
- c. The shape of the particle can never be totally spherical and the shape of the particle has a strong effect on the settling speed.

Taking all the above factors into account, Newton has provided a modified equation for determining the terminal velocity under turbulent condition:

$$v_t = \sqrt{\frac{8}{3Q} g \frac{(\rho_p - \rho') r_p}{\rho'}}$$

Where, Q = Coefficient of fluid resistance which varies with the shape of the particle and orientation of the particle to the direction of relative motion. For spherical minerals in water Q is about 0.4 if $r_p > 0.20\text{cm}$.

To sum up:

For the viscous or laminar flow the terminal velocity varies as the square of particle diameter and in turbulent flow it varies as the square root of particle diameter.

$$v_t \propto r_p^2 \text{ for viscous flow.}$$

$$v_t \propto \sqrt{r_p} \text{ for turbulent flow.}$$

Pulp or slurry:

When tiny particles are added to the fluid in large quantity they get suspended in fluid and form a pseudo fluid with an apparent specific gravity. The apparent specific gravity of fluid is higher than that of pure fluid. Such a fluid is known as slurry or pulp. In such cases the specific gravity of the fluid medium must be replaced by the specific gravity of the pulp (slurry) to find out the terminal velocity under turbulent flow (Newton's law) condition. Hence, terminal velocity under hindered settling condition:

$$v_t = \sqrt{\frac{8}{3Q} g \frac{(\rho_p - \rho'')r_p}{\rho''}}, \text{ where } \rho'' \text{ is the specific gravity of the slurry in}$$

place of specific gravity of the pure fluid (ρ').

Equal Settling Particles:

The particles are said to be *equal settling* if they have the same terminal velocities in the same fluid and in the same field of force. The *free settling ratio (F.S.R)* is calculated by applying Stoke's law as follow:

$$v_{t1} = \frac{2 r_1^2 (\rho_{p1} - \rho_f) g}{9 \mu} = v_{t2} = \frac{2 r_2^2 (\rho_{p2} - \rho_f) g}{9 \mu}$$

$$\text{Or, } r_1^2 (\rho_{p1} - \rho_f) = r_2^2 (\rho_{p2} - \rho_f)$$

$$FSR = R_f = \sqrt{\frac{\rho_{p1} - \rho_f}{\rho_{p2} - \rho_f}} = \left[\frac{\rho_{p1} - \rho_f}{\rho_{p2} - \rho_f} \right]^{\frac{1}{2}}, \text{ where, } \rho_{p1} \text{ \& } \rho_{p2} \text{ are the specific gravities of the two particles respectively and } \rho_f \text{ is the specific gravity of the fluid. Similarly the hindered settling ratio can also be deduced as:}$$

$$HSR = R_h = \left[\frac{\rho_{p1} - \rho''}{\rho_{p2} - \rho''} \right]^m, \text{ where } \rho'' \text{ is the specific gravity of the suspension rather than the pure fluid and } R_h \text{ is the hindered settling ratio and } m \text{ is the}$$

exponent whose value varies between $1 \frac{1}{2}$.

(Newton) $1 > m > 1/2$ (Stokes).

The concept of *free and hindered settling ratios (FSR & HSR)* can be employed suitably in classifiers to segregate particles according to their size and specific gravity.

Classification:

Classification is a process by which particles of various sizes, shapes and specific gravities are separated into separate groups by allowing them to settle in a fluid medium. The coarse and heavier grains settle faster than the finer and lighter grains. Usually, air or water is used as the fluid medium. Classification may be regarded as a mineral beneficiation process based primarily on Stokes' law of sedimentation.

Factors affecting classification:

1. Specific gravity:

For particles of same size but different specific gravities, the particle having the highest specific gravity will settle fastest than any other particle.

2. Size:

For particles of same specific gravity but different sizes, the largest one will settle fastest than any other particle.

3. Shape:

Spherical particles settle faster than the narrower, longer and flatter particles.

4. Specific gravity of the fluid:

In fluids of different specific gravities, the particle will settle fastest in the lightest fluid.

5. Air bubbles:

Adherence of air bubbles to the solid particles would decrease the settling speed.

Classifiers:

Basing on the above discussed ideas, classifiers are broadly classified into three categories:

1. *Sorting classifier*: It uses a relatively dense aqueous suspension as the fluid medium for classification.

2. *Sizing classifier*: It uses a relatively dilute aqueous suspension as the fluid medium for classification.

3. *Sizing classifiers*: It uses air as the fluid medium for classification.

Sorting Classifiers:

Hindered settling takes place in sorting classifiers. The separation achieved by *sorting* is a *sizing operation* modified by specific gravity & shape of the particle. It is usually applied to coarser products. A dense suspension of 40 - 70% solids by weight is used depending on specific gravity, size of the particles to be sorted. The usual types of sorting classifiers are:

a. A simple launder classifier or Evans' classifier.

b. Richard's hinder settling classifier.

c. Richard's pulsator classifier.

d. Hydrotator classifier.

Evans Classifier:

Evans' classifier consists of a sloping launder, *A*. Opening to this launder several rectangular boxes *BC* are attached. To the rectangular boxes spigots, *O* are fitted which are capable of discharging out. Pipes are suspended from a main water pipeline into the rectangular boxes. Water is introduced into the boxes through these pipes and the flow is controlled by valve, *F*.

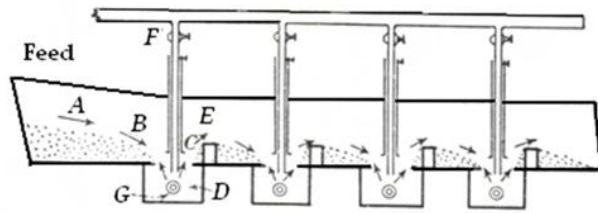

Fig.5.3. Evans Classifier.

The working of this classifier is quite simple. As water is introduced into the boxes, faster settling particles are discharged out through the spigot and slower settling particles overflow at *E*, to the next box in the launder. Baffles, *E* are fitted to the launder to restrict the return of particles to the same box from where they have been taken away as overflow. Depending upon the number of rectangular boxes & spigot attached to the launder several products are obtained. Water flow rate in each successive pipe is reduced as the sizes of the particles settling get reduced successively.

Richards Hindered Setting Classifier:

It is a modified version of Evans classifier. In this classifier, cylindrical sorting columns replace the boxes of the Evans classifier. More interestingly water is introduced into the cylindrical sorting column from below through radial or tangential ports. Richards Pulsator classifier is characterized by the use of an intermittent or pulsating upward current of water designed to make settling totally hindered.

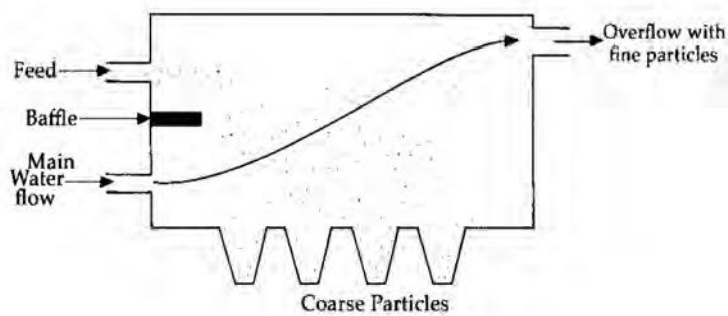

Fig.5.4. Richards Hindered Settler.

Sizing Classifiers:

Sizing classifiers utilize free settling conditions to effect sizing as much as possible being unaffected by specific gravity & shape of the particles. These classifiers do not require any additional water besides that is present in the suspension undergoing classification. Sizing classifier may be subdivided into:

- a. *Settling cones* having no moving parts and
- b. *Mechanical classifiers* having moving parts.

They may use water or air as classifying medium. Classifier using air is known as *pneumatic classifier* where the settling speed is around 100 times faster as compared to the settling speeds in water classifiers.

Settling Cones:

Settling cones are conical sheet metal shells with apex at the bottom and a peripheral overflow launder at the top. Feed is charged through the central cylindrical bottomless pipe as shown in the figure 5.5 to prevent the bypassing of the feed to the overflow. Spigot at the bottom of the conical shell discharges the sediment. A gooseneck pipe of adjustable height is provided to guide the sediment away from the tank.

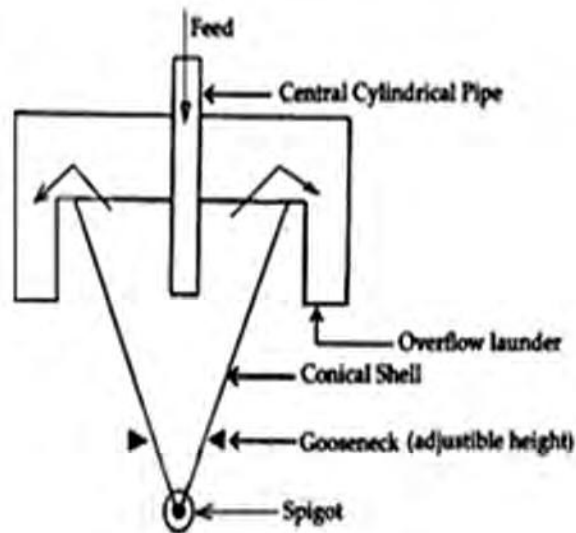
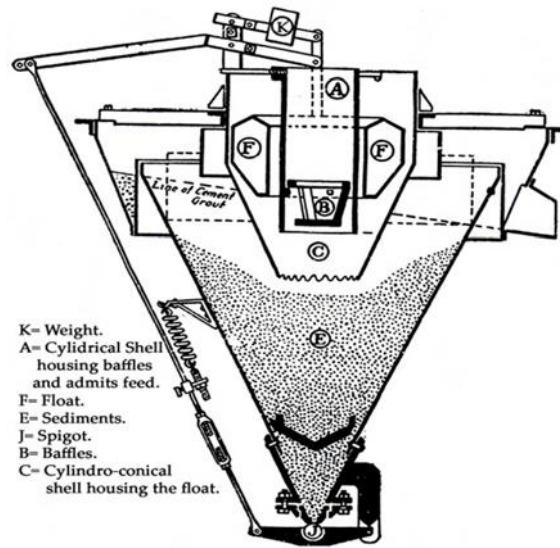

Fig.5.5. Settling Cone

Allen Cone Classifier and its Construction: This is a mechanical classifier as it involves moving parts. The main difference between Settling & Allen cone is the automatic discharge of the classified material in case of the latter one. The shape of Allen cone classifier is quite similar to that of settling cone. A float, *F* is situated within the cylindro-conical shell, *C* which surrounds the feed shell, *A*. The baffle, *B* is working against a spring to keep the spigot, *J* closed. When the level of sediment, *E* rises sufficiently in the cone, it prevents the passage of pulp from the feed shell, *C* to the body of the classifier. Then the float is raised and it opens the spigot allowing discharge to take place automatically. Discharge will continue until the float is brought back to its redetermined initial position. The effect will be same when density is raised. The discharge will continue until the density is brought back to the initial level. The density is regulated by a mechanical weight, *K* adjustment.



K= Weight.
 A= Cylidrical Shell housing baffles and admits feed.
 F= Float.
 E= Sediments.
 J= Spigot.
 B= Baffles.
 C= Cyllindro-conical shell housing the float.

Allen Cone Classifier.

Performance of Classifiers:

1. Capacity:

The capacity of a classifier is directly proportional to the following variables:

1. Cross- sectional area of the sorting columns.
2. The raising velocity of the fluid (*water or air*) in the sorting columns.
3. The percentage of solid in the classifier intake or feed.
4. Specific gravity of the solid.

The capacity of the classifier C (tons of solids per hour) is expressed by the formula:

$$C = aAv\gamma\rho \text{ where,}$$

A = The cross-sectional area in square feet.

v = Upward velocity or fluid feet per minute.

γ = Percentage of solid by volume

ρ = Specific gravity of the solids.

a is a constant = 1.875 to obtain C in tons per hour.

2. Efficiency:

It is difficult to quantify the efficiency of the classifiers. However the usual methods consist of screening of the classifier overflow & underflow and then calculate the efficiency using the formula: $E = 100 \times \frac{c(f-t)}{f(c-t)}$, where, E is the

efficiency expressed in percentage, c, f, t are the content of minus X -mesh(- X #) material in the *overflow, feed & underflow* respectively. X being any size such that neither c nor t or f is zero. But many metallurgists do not agree to this efficiency (E) calculation. The point of objection is that, if some feed is by-passed to the overflow the efficiency increases theoretically but practically there is no increase in the efficiency of the classifier. Hence, it has been proposed to use: $E = \frac{10,000(c-f)(f-t)}{f(100-f)(c-t)}$, c, f & t have the same meaning as discussed

before. This formula expresses efficiency as a ratio on percentage basis of the classified material in the feed. It gives a lower value than the previous formula and more practical. The efficiency of classification ranges from 50 - 80%.

3. Cost of operation:

The cost of classification is strikingly less except for fine sized material. In large plants total cost of classification is around Rs. 15 per ton, but this depends largely on capital and inventory cost.

Flocculation:

The opposite meaning of flocculation is dispersion. In a dispersed state, the crushed material is in a suspended state and fails to settle down regardless of the settling time used (similar to colloidal solution). But the same pulp can be conditioned in such a fashion that, few particles can come together to form flocks of larger size with appreciable weight to settle down. So the physiochemical process which increases the tendency of individual particles to form flocs and then settle down is known as flocculation. The reverse of this process is known as *deflocculation*.

CHAPTER 6

HEAVY MEDIA SEPARATION

Introduction:

If a fluid is available whose specific gravity is intermediate between two solids which are to be separated, then one of the simplest processes will be to suspend the mixed mass in that fluid. As per law of buoyancy, one of the solids will float at the top of fluid level while the other one will sink to the bottom of the vessel. Then a mechanical arrangement will be required to draw out different products from the top and bottom of the vessel. A typical example can be the separation of wood chips from gravel or sand using water medium.

Principle of Heavy Media Separation:

The basic principle involved in the gravity concentration process is the 'Float and Sink'. This is carried out by using a fluid whose specific gravity is in between the specific gravities of the two mixed up minerals particles in the crushed ore. Since most of the minerals are heavier than water, water is not a suitable fluid medium for practicing 'float and sink' method of separation. For this process to be effective fluids heavier than water are required.

Laboratory Grade Heavy Fluids:

Most of the heavy organic liquids are used as heavy fluids and can be used only on a laboratory scale to assess the optimum separation obtainable by gravity concentration. One of the most useful heavy fluids is acetylene tetra bromide whose specific gravity is **2.96**. This fluid can be diluted with carbon tetra chloride with sp.g of 1.59 to yield a series of fluids with a sp.g varying from **2.96 to 1.59**.

Another group of useful fluids of low specific gravity is the aqueous solution of zinc chloride (**ZnCl₂**) and calcium chloride (**CaCl₂**). High cost of laboratory heavy fluids precludes their employment in industrial applications

Industrial Grade Heavy Fluids:

For industrial application pseudo liquids can be prepared by suspending solids in water. These fluids can be used almost like true liquids provided the particles to be separated are coarser compared to the size of particles used to prepare the medium. This medium is continuously agitated to prevent settling of particles used to form the pseudo fluid but the agitation allows the settling of heavy particles in the crushed ore to be separated. Finely divided quartz, magnetite, galena or ferrosilicon is used for making up the suspension. The

range of specific gravity for fluids of commercial interest is 1.3-2. Such fluids are mainly used to separate coal from clay. Pseudo fluids are much cheaper than organic liquids of high specific gravity, so the cost of fluid loss is not significant. But on the other hand, the use of pseudo fluids is not as simple as that of true fluids.

Heavy Media Separation Circuit:

A simple heavy media separation circuit would essentially consist of the followings:

- i. A separating vessel in which heavy suspension is kept with a provision for introducing the feed and withdrawing the product continuously.
- ii. Means to clean the product separated, recover the media and recirculate it to the vessel for further utilization.

Specific Industrial Processes Using Heavy Liquids:

Three different processes have been developed until now using true heavy liquids. The processes are:

1. Lessing Process.
2. Bertrand Process.
3. Du Pont Process.

Lessing Process:

Lessing process is used to clean coal in a solution of calcium chloride having an approximate specific gravity of 1.4. It is most useful in separating coal from clay & slate.

Lessing's Settling Tank:

Settling takes place in a cylindrical tank of **30 ft** height & **6-10 ft** diameter with a conical bottom as shown schematically in the figure 6.2. Graded raw coal freed from dust and fines is introduced into the tank through a central pipe to mix up with the separating solution thoroughly. As per "float & sink" principle cleaned coal floats up and is removed from the tank by a chain scrapper or any such mechanical arrangement. The slate, shale and sand drop to the conical bottom and are removed by the help of a bucket conveyor. Both cleaned coal and slate are delivered to the draining towers.

After draining, they are washed clean of the **CaCl₂** solution. The wash liquor is returned to the concentration tank for recalculation **CaCl₂** solution to the settling tank.

320 liters of **CaCl₂** liquor is withdrawn from the separating tank after each ton of raw coal cleaned. During cleaning of coal the specific gravity of the parting solution drops to 1.2 from 1.4 due to addition of wash water and inherent moisture in the coal. **320** liters of parting liquid withdrawn from the tank is made-up to **640** liters and concentrated to a volume to yield **CaCl₂**

solution of specific gravity 1.4. Subsequently the solution is recirculated to the separating tank for further cleaning of coal.

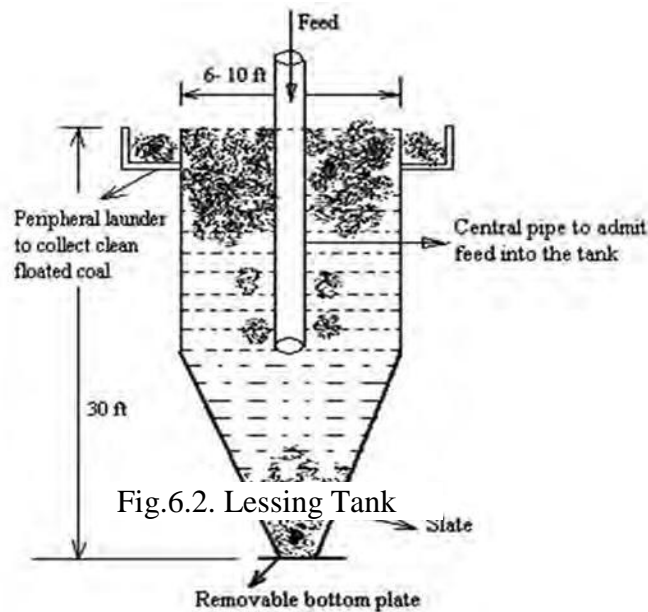

6.7.1.1.

Process Characteristics:

1. The loss of calcium chloride solution during washing of coal is in the order of 2-3 liters per ton of raw coal cleaned.
2. The process produces extremely clean coal.
3. Because the process constitutes a costly thermal concentration process, widespread adoption of this process has been restricted.

Bertrand Process:

Bertrand process also uses calcium chloride solution as separating medium and is applicable only to deslimed coal. The process is mainly utilized for washing of coal of 1-5mm size. This process is different to Lessing process with respect to feeding method. Here the feed material is charged into the system in a counter current fashion starting from water to separating solution.

Purified coal & waste are being withdrawn in a similar counter current fashion. There are five (5) circulating liquors such as hot water, weak solution, medium solution, strong solution & separating solution as shown schematically in the figure 6.2.

Characteristics of the process:

1. This process avoids costly thermal concentration of dilute solution.
2. This process introduces relatively complex hydro-metallurgical flow sheet compared to Lessing process.
3. The results obtained by the above two process are excellent and coal of extremely high grade coal is obtained.

Du-Pont Process:

Du Pont process is the practical adoption of laboratory heavy - liquid separation. This doesn't differ from laboratory procedure in basic principles, but requires some special treatments to be commercially viable.

Special Requirements of Du Pont Process:

1. Parting liquid or the separating solution should have low solubility of the in water and water in parting liquid.
2. Parting fluid should have low viscosity or high fluidity at the operating temperatures.
3. Parting fluid should have high stability, low vapour pressure.
4. Parting fluid should be nonflammable.
5. Prior preparation of the ore is required for removing fines before parting.
6. Prior preparation of the ore with suitable chemicals is required to make the surfaces of the particles immune to wetting by the parting liquid.
7. Complete sealing of the separating system to prevent loss of parting fluid by evaporation and further to eliminate health hazards due to the noxious vapours emanating from the parting liquid.
8. Procedure should be available for complete separation of parting liquid from the minerals so as to regenerate the parting liquid.
9. The process should use of a scheme to purify the parting liquid constantly.

The requirement listed at No.6 is the most important among all conditions. During cleaning of coal, active agents like starch acetate or stannic acid of the order of 0.011 % wt. of the total weight is used. The process is shown schematically in the figure.

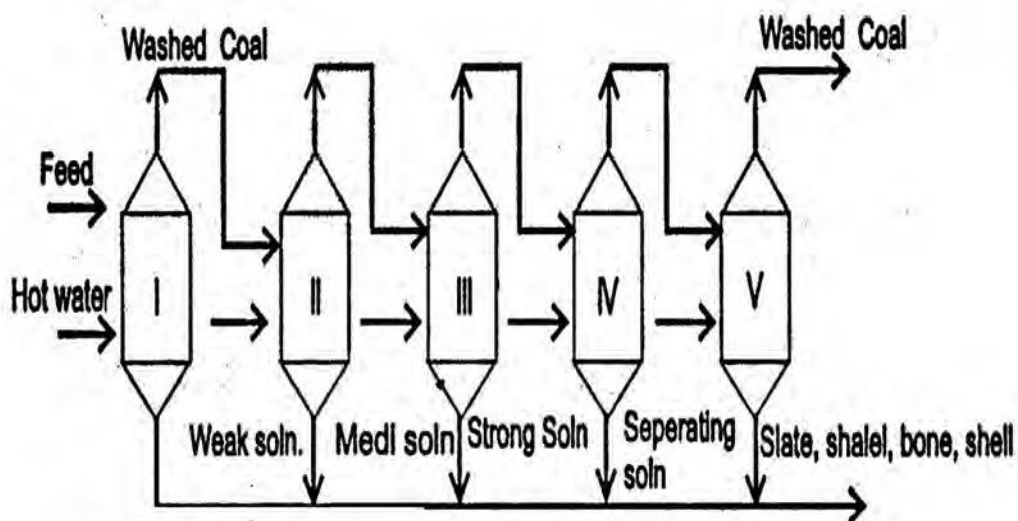

Fig Schematic Flow Diagram of Du-Pont Process.

Characteristics of Du-Pont Process:

1. Parting liquid in case of Du-Pont process is a mixture of several halogenated hydrocarbons.
2. The main expense in Du Pont process is the cost of parting liquid.
3. The consumption of parting liquid is in the order of 450grams per ton of coal cleaned.
4. Separation process is fairly simple in principle but requires a number of adjunct operations for the sake of economy in reagents consumption.
5. The process is not applicable to fine particles and is limited to coarse state of sub-division.

Industrial Processes Using Heavy Suspensions Or Pseudo Fluids:

Pseudo heavy fluids are manufactured by suspending quartz, ferrosilicon or galena in different proportions to have the requisite specific gravity. The processes are:

1. Chance process
2. Vooyoys process
3. Wuensch process

Chance Process:

Chance Process is in use for last 100 years for cleaning coal. The parting fluid is a suspension of quartz or sand particles in water. The sand used here is in the size range of -40 to +80 #. The *Chance Cleaner* consists of a separating tank or a *Cone Separator* in which sand suspension moves up gently. An agitator is used for stirring the suspension to prevent packing. The overflow of clean coal and sand passes over to the cleaning screens which desand and dewater the coal. Spray water is used for desanding. The specific gravity of the fluid is adjusted by varying the proportions of sand and water. For cleaning anthracite coal a heavier fluid is used than compared to the fluid used for cleaning bituminous coal. Figure shows the Chance process schematically.

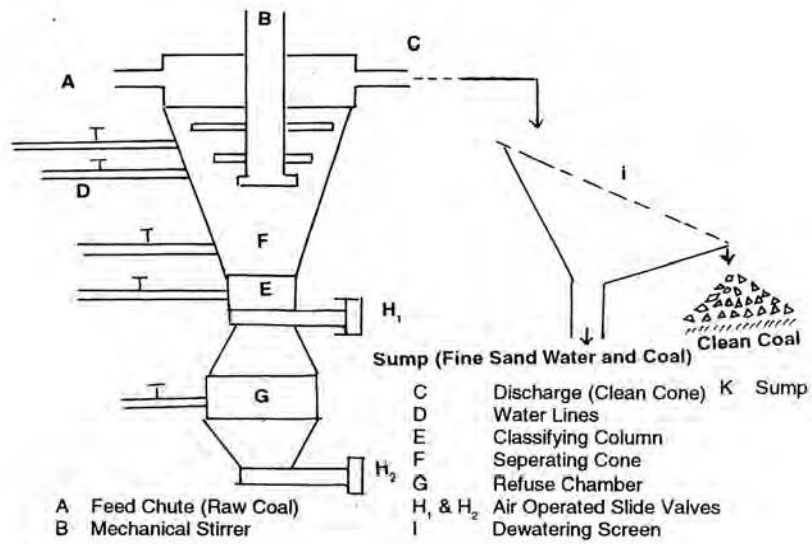

Fig.6.3. Schematic Chance Cleaner.

Voys process:

This process uses a suspension of finely grounded barite (-150 to +200#) in water. Specific gravity is adjusted to 1.47 to clean coal. Coal particles finer than 100- mesh are excluded. Since the solid particles used to manufacture the parting fluid are much smaller than what is used in the chance process, the coal that can be treated by Voys process can also be much finer.

CHAPTER 7

JIGGING

Introduction:

Jigging is one of the most ancient methods of ore concentration. It is a special form of hindered settling resulting in stratification of particles into layers of different specific gravities followed by removal of the stratified layers. The stratification is achieved by repeatedly affording an opportunity to a very thick suspension of mixed particles to settle for a short time.

Principles of Jigging:

The three physical factors responsible for stratifications of particles during jigging are:

- a. Hindered settling classification.
- b. Differential acceleration at the beginning of the fall.
- c. Consolidation trickling at the end of the fall.

Hindered settling classification:

The essential difference in hindered settling in jigs and classifiers is that in jigging the solid - fluid mixture is very thick and it approximates to a loosely packed bed of solids with interstitial fluid flowing through the particles rather than fluid carrying the solid particles with it happens in the case of classifiers. The thick solid-fluid suspension used in jigs cannot be maintained for a long length of time and also doesn't allow sufficient play between the particles for their complete rearrangement. As the jigs produce a fluidized bed for few seconds, it offers an open bed alternatively and particle rearrangement takes place during that time period only. Other parameters remaining same higher settling ratios are obtainable in jigs compared to classifiers. Figure shows the effect of hindered settling during jigging.

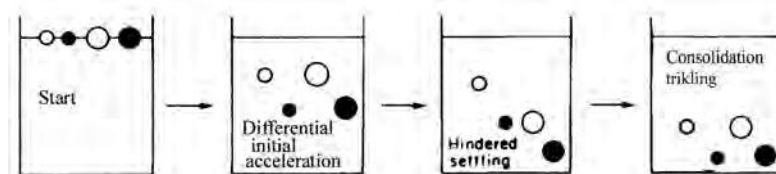

Differential Acceleration:

In jigs particles are allowed to move and allowed to get rearranged during their accelerating time periods only. The heavy particles have a greater initial acceleration and speed than the lighter particles. *So if the fall is repeated for short durations then the total distance travelled by the particle bears a resemblance to its initial acceleration than to its terminal velocity (V_t).* Stratification of particles will take place according to the specific gravity of the particle alone. The important issue is whether such short falls can be realized or not. Mathematically differential acceleration at the beginning of the fall can be derived as discussed below.

Mathematical Derivation for Differential Acceleration:

Applying law of sedimentation:

$m \cdot dv/dt = (m-m') \cdot g - R(V)$, where,

V is the velocity of the particle against the fluid motion,

m is the mass of the solid particle,

m' is the mass of the fluid displaced by the particle,

$R(V)$ is the fluid resistance force working on the particle.

At the beginning of the fall the velocity of the particle in the fluid is zero which implies: $R(V) = 0$

Hence at the beginning of the fall:

$m \cdot dv/dt = (m-m') \cdot g$,

Or, $dv/dt = [1 - \frac{\rho_f}{\rho_s}]g$, -----(1)

Where, ρ_f and ρ_s are the specific gravities of fluid and the solid particle settling in the fluid respectively. From the equation (1) it is clear that the initial acceleration of the mineral grains is thus independent of the size but is dependant only on the specific gravities of the solid and fluid. Theoretically, if the duration of the fall is short enough and the *fall* is repeated for sufficient number of times, the total distance travelled by the particles will be controlled directly by the initial differential acceleration or indirectly by the specific gravity and size of the particle rather than the terminal velocity of the particle.

To separate small heavy from large light mineral particles a short jiggling cycle is required.

If the mineral particles are afforded a longer time to settle during jiggling, they will attain their terminal velocity and will settle according to their specific gravity and size.

Consolidation Trickling:

It is a fact that different particles of either same or different specific gravities do not travel the same distance during the settling period. So they appear at different heights in a stratified bed. Finer particles may appear on the top of a bed of coarse particles. The finer particles may run down through the interstitial pore spaces available in the bed of coarse particles under the influence of gravity & vibration. This particular phenomenon is known as *consolidation trickling*. In true sense *consolidation trickling* is opposite to jiggling as it leads to an intermixing of smaller particles of lower specific gravity with coarser particles of higher specific gravity. The effect of consolidation trickling is shown schematically in the figure

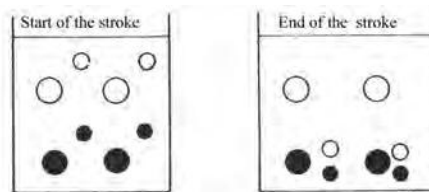

To summarize, stratification during the stage when the bed is open is essentially controlled by hindered settling and initial differential acceleration. During the suction stage, when the bed is tight the stratification is controlled by consolidation trickling. Hindered settling and the initial differential acceleration put the *coarse-heavy grains* at the bottom, fine-heavy & coarse-light grains in the middle and fine-light grains at the top of a stratified ore bed. Consolidation trickling reverses this process to some extent. The effect of ideal jiggling process is shown in the figure---10.5 385 wills.

Jiggling Cycles:

Short falls are to be realized in jigs for stratification to occur. This is obtained by pulsation and suction of water or any other fluid through a bed of ground ore held on a perforated grate or sieve. During pulsation & suction the fluid moves up and downward respectively with reference to a stationary point.

During pulsation the ore bed expands while during suction the bed gets compacted. Most jigs use both pulsation & suction, but in some jigs the suction is avoided. The plot of fluid velocity with respect to time describing a full cycle of pulsation and suction is termed as *jigging cycle*. A jigging cycle is shown schematically in the figure 7.4 with reference to the movement of piston in a jig.

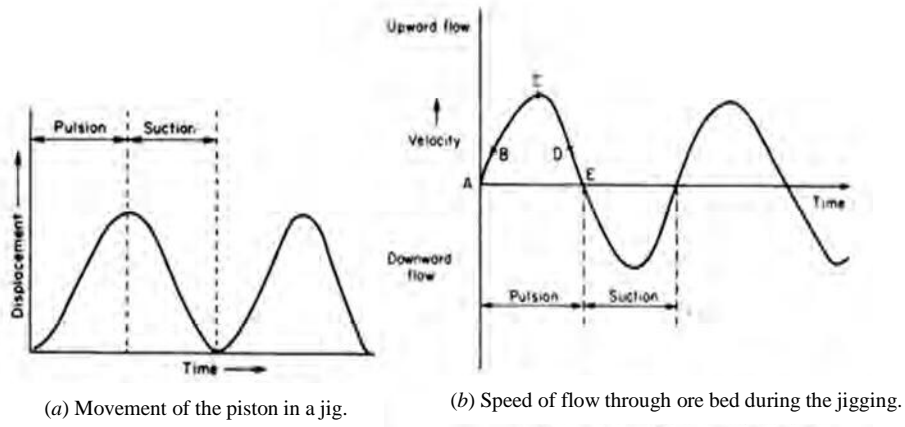

Fig. A Schematic Jigging Cycle.

Different jigging cycles:

Jigging cycle is said to consist of pulsation and suction. Figure 7.5 shows several jigging cycles schematically.

Type A & B use pulsation only.

Type C & D use pulsation and suction both being symmetrical.

Type E asymmetrical pulsation and suction.

Type F symmetric but unequal suction and pulsation.

Jigging characteristics:

1. Equal Jigging Particles and Jigging Ratio (J.R):

If two particles settle to equal distance during a fixed time period of fall, they are said to be *equally jigging* further *Jigging ratio* is defined as *the ratio of diameters of equal-jigging particles*. Jigging ratio is a function of duration of fall (T_x). Clearly if jigging is practiced on the unsized or on poorly sized feed, a very short duration of fall (T_x) should be used for stratification to result. If jigging is practised on closely sized feed by screening stratification can be obtained for longer settling time.

2. Rate of stratification:

The figure 7.6 shows the distance gained per second by one of particle over the other particle. Galena particles of 0.2 cm in radius gain over the equal settling quartz particles regardless of the duration of period. The gain is nil if the time of settling is infinitely small or infinitely large.

Rate of gain for fine heavy is less than the rate of gain for the coarse heavy particles, so large number of settling periods are required if stratifications of un-sized feed is to be obtained. If unsized feed is treated for proper stratification, capacity would decrease.

The Jig:

A jig is essentially a water filled box in which a bed of mineral grains are supported on a perforated surface or screen. Jigs are usually made up of wood or other materials. In place of one compartment there may be several compartments connected in series. The tailing of one compartment works as feed for to the next consecutive compartment in the series. The amplitude of jigging is maximum in the first cell and minimum in the last cell. When water is pulsed through the screen, the particles are brought into suspension in water and are allowed to settle under hindered settling conditions which are modified greatly by differential acceleration (the theory of jigging has been discussed earlier). If the settling periods are of very short duration, the separation of two materials according to the specific gravities may be possible almost regardless of the size. This explains how the jig can handle wide range of size distribution. It is evident that with a feed of a wide size range, a very short settling time must be used for complete stratification.

Basic Construction of a Jig:

The major components of a Jig are:

1. A shallow open tank containing a screen-bottom on which the ore is supported.
2. A hydraulic water chamber or *hutch*.
3. A reciprocating mechanism for pulsating water through the sieve.

Classification of Jigs:

Jigs are classified to two types:

- a. Hand jig.
- b. Mechanical jig.

Hand jig:

This is the simplest of all jigs which consists of a framed sieve held by hands and is actuated by the operator with a reciprocating vertical motion. In general a perforated cylindrical shape container is used. After filling up the vessel with minerals up to the desired level it is closed tightly. With a rope and pulley arrangement it is made to move up and down in a water tank to attain the condition of pulsation and suction of water in the mineral bed. As the process is continued or repeated for several times complete stratification takes place. This jig is mainly used in the laboratory to demonstrate the effect of jigging operation. Figure shows the basic features of a hand jig.

Mechanical jigs:

Mechanical Jigs are of various types. But regardless of type they are essentially composed of:

- i. A shallow open tank containing a screen-bottom on which ore is supported.
- ii. A hydraulic water chamber or *hutch*.
- iii. A reciprocating system for pulsation and suction of water through the screen.

Typical Mechanical Jig:

There are different mechanical jigs such as:

1. Fixed sieve plunger jig.
2. Fixed sieve Pulsator jig.
3. Pneumatic or Baum jig.

Working of few important jigs is discussed below.

1. Fixed Sieve Plunger Jig (Harz Jig):

The harz jig has a fixed sieve. The jiggling motion is obtained by plunger, *P* reciprocating in a compartment adjoining the sieve compartment, *C*. The bottom layer (usually the concentrate) is removed through the gate, *A*. The upper layer (usually tailings) is discharged at the end away from the feed.

Working:

The crushed & graded ore is held on the sieve, *C*. Water is held in the hutch, when the plunger is pushed down water rushes up and when the plunger is moved up, water rushes down through the mineral bed held on the screen.

When water moves up it imparts a pulsation and when water moves down it imparts suction to the mineral bed. So both pulsation and suction takes place alternatively resulting in jiggling. Jiggling duration ranges from 0.2 to 0.6 sec (100-300 cycles per minute).

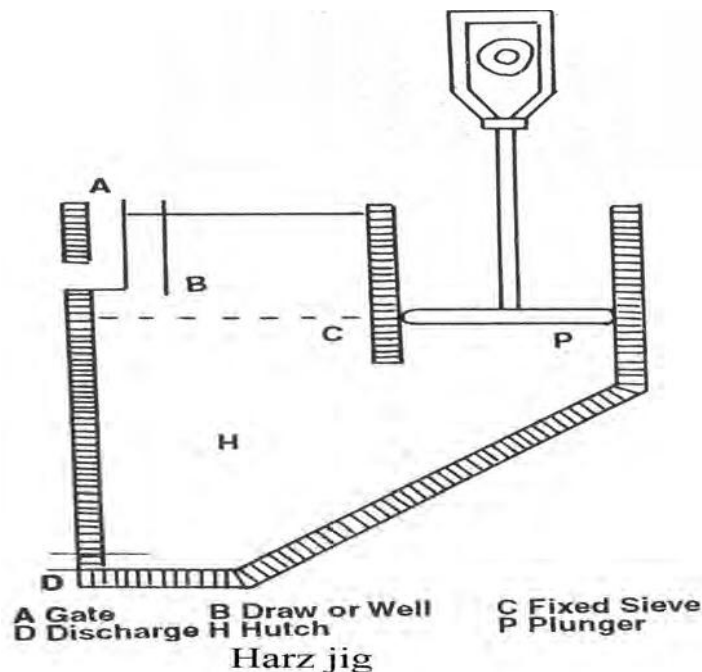

2. Plunger Jig: The plunger jig consists of ore box of size: 24''x8''x6'' fitted to one half of the tank and then plunger is fixed in the other half. The plunger is made to move up and down by mechanical arrangement. The bifurcation board between the jigging and plunger section at the centre extend sufficiently below the jigging sieve to ensure even arrival of water impulses at the sieve. Sieve plays an important role in jigging. Different types of jigs are used for different materials. Smaller materials use woven wire sieves, average sized material use punch plates while larger sized materials need barred grates

3. Pulsator jigs:

In this class of jigs there no suction stroke. The jigging is due to impulses of water flowing under pressure from the water service point. These impulses are obtained by placing a rotating device in the water service line. The number of impulses is around 200/minute. This type of jig can handle around 100tons/sq.foot/day.

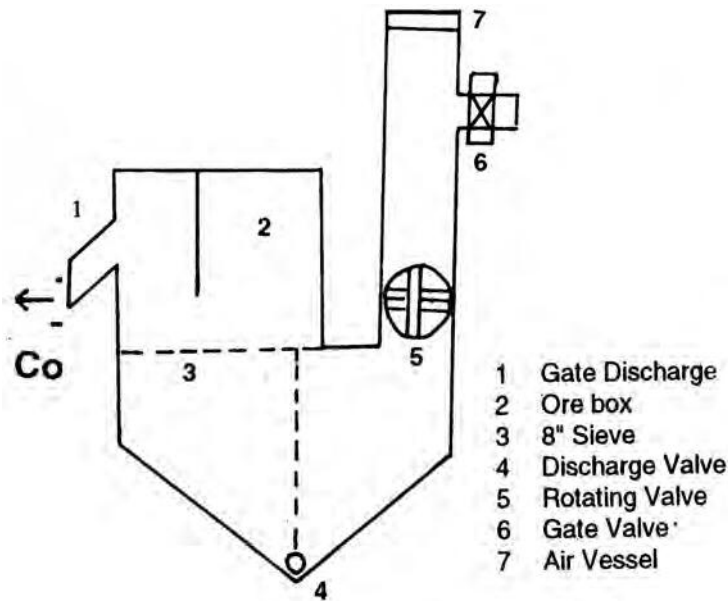

Pulsator Jig

- 1 Sieve
- 2 Jigging Section
- 3 Valve
- 4 Plunger

Plunger Jig

Compared to the Harz jig, the Bendelari jig has a more open bed, larger capacity consumes less water and requires less maintenance. The jiggling cycles range from 0.2-0.8 seconds, i.e.100-160 strokes per minute.

4.Pneumatic or Baum Jigs:

Baum jig resembles the plunger jig in construction but differs in the working principle. With little modification it has been in use for the last 150 years. Presently it is extremely popular in coal washing.

In this case air under pressure is forced in& out of a large air chamber on one side of the jig vessel causing pulsion and suction to the jig water. This in turn causes pulsion and suction through the crushed coal bed held on the screen. Thus stratification is caused finally. Baum jig has the advantage of handling wide range of sizes with high capacity.

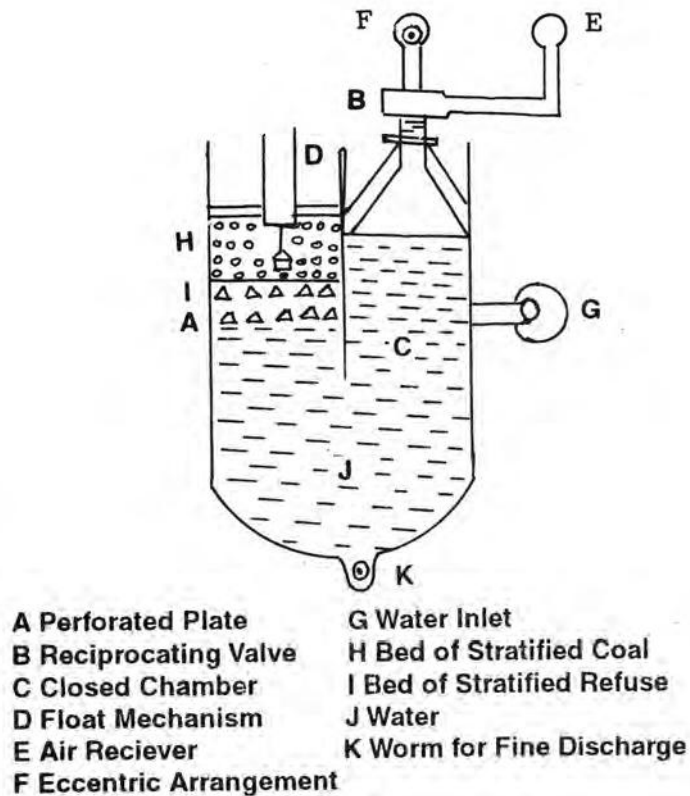

Fig. Baum Jig

Advantages of Jigs:

1. Jigs are primarily used to concentrate coarse-minerals. In coal washing, up to 4 - 5 inches coal pieces can be washed in Jigs. In case of ores, pieces up to I inch size can be treated. Hydraulic jigs can wash coal up to 1/8 inch & minerals as fine as 20#. Pneumatic jigs can treat minerals as fine 65# mesh and as coarse as 1-1.5 inches but not in a wider size range.
2. Excluding washing of coal it is used widely to beneficiate non magnetic iron ores.
3. Jigs are cheap to operate and substantially foolproof and offers an easy access for inspection.

Limitations of Jigs:

1. Jigs are obsolete for sulphide ores.
2. It requires large amount of water during ore beneficiation.
3. Fines cannot be treated in jigs. Jigging is applicable to the ore that is too coarse for complete liberation.
4. Jigs do not provide a complete solution to any mineral beneficiation problem.

CHAPTER 8

FLOWING FILM CONCENTRATION & TABLING

Introduction:

Before discussing the principles of flowing films concentration, it is important to have an idea of fluid flow. Fluid flow can be classified into three categories:

- a. Laminar or streamline flow.
- b. Turbulent flow or erratic flow.
- c. Mixed flow; A combination of laminar and turbulent flow.

All these fluid flow conditions are determined quantitatively by studying about the dimensionless quantity Reynolds number (R_e).

Mathematically:

$$R_e = \frac{Dv}{\nu} \text{ where,}$$

D = Diameter of the pipe in centimeters.

v = Average velocity of fluid in the pipe, centimeter/sec.

ν = is a term defined as *Viscosity* of the fluid.

The flow pattern can be determined theoretically from the numerical value of the Reynolds R_e number for that flow.

- a. If $R_e \leq 2100$ then such a flow is termed as laminar flow.
- b. If $R_e > 4000$ then such a flow is termed as turbulent flow or erratic flow.
- c. If the condition is such that $2100 < R_e \leq 4000$ then such a flow is termed as mixed flow.

Viscosity of Fluids (γ):

Viscosity is defined as the internal friction of fluid which resists the shear force acting on the fluid. This is an intrinsic property of the fluid at particular temperature & pressure. For liquids a rise in temperature lowers the viscosity ν and for gases rise in temperature increases the viscosity ν . Both viscosity and kinematic viscosity are interrelated with a factor i.e., the specific gravity of the fluid.

Mathematically:

$$\gamma = \frac{\nu}{\rho}$$

γ = Kinematic viscosity of the fluid.

ν = Viscosity of the fluid

ρ = Specific gravity of the fluid

Units:

1. Viscosity unit is poise = 1 dyne .sec /cm²
2. Kinematic viscosity unit is Stoke.

Flowing Film Concentration:

Liquid films under laminar flow have specific mechanical property that can be easily adopted to separate the minerals according their specific gravities. The specific mechanical property is that, the velocity of the fluid is not the same at

all depths of the film.

Similarly in case of a pipe, the flow rate is highest along the central axis and nil at the inner periphery of the pipe. This property in turn depends upon the viscosity of the fluid.

This physical sense of speed difference during fluid flow at different depths can be exploited industrially to result in mineral beneficiation. The flowing fluid film can effectively separate coarse light particles from the dense smaller particles. The action of a flowing fluid film on the mineral grains is shown schematically in the figure.

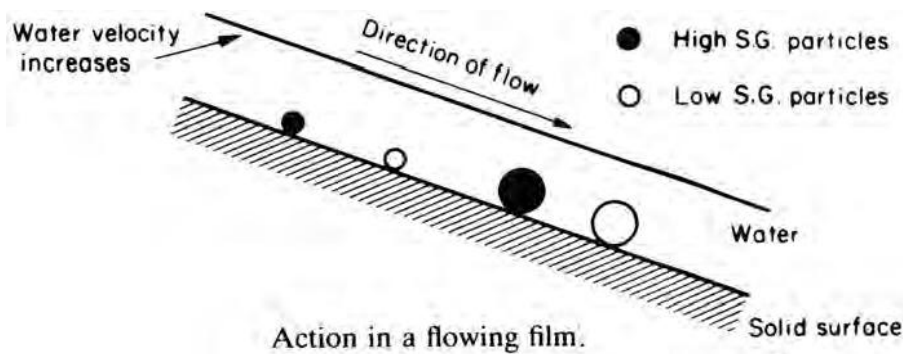

Action in a Flowing Film.

Mineral beneficiation carried out by the above principle is known as *Tabling*. The experimental facts regarding particle classification utilizing the principle of flowing film concentration can be summarized as follows where the down slope sequence of particles is:

1. Fine-heavy particles.
2. Coarse-heavy and fine light particles.
3. Coarse - light particles.

In fact rounded particles move farther down the stream than the heavier, finer and flatter particles. It is interesting to note that flowing film concentration places the coarse heavy particles with fine-light particles which is reverse to the stratification that takes place during jigging. This suggests the desirability of classifying the feed in a flowing film concentrator.

Tabling:

Tabling takes place on the Shaking or Wilfley table. The Shaking or Wilfley table essentially consist of a substantially plane surface called the deck. The table is slightly inclined to the horizontal from the left to right and shaken with an asymmetrical motion in the direction of the long axis.

Asymmetrical motion makes the stroke of the table faster in one of the directions and slower in reverse. Usually a slow forward with a rapid return is used during the operation of the Wilfley table. This causes the mineral particles to crawl along the longitudinal cleats or riffles that are fixed on the table surface in the direction of the table movement. The wash water flows over the table at right-angles to the direction of jog. A feed of 25% solids by weight is introduced through the feed box at the upper corner of the table and as the feed particles hit the deck they are fanned out by a combination of differential motion and transversely flowing water. The jolt during the return stroke causes the heavier particles to work- down the bed to form the bottom layer. The lighter gangue materials are thrown into suspension and are discharged out over the edge of the table opposite to the feed box by the wash water. The heavier minerals finally arrange themselves on the smooth unriffled proportion of the table when they encounter the full force of the wash water. The middlings are collected in that portion of the table intermediate between concentrate & tailings.

The reciprocating speed of the Wilfley table is usually 200-300 strokes/minutes with an amplitude or stroke length of 12-15mm. A finer feed requires a higher reciprocating speed but a smaller stroke length while a coarser feed requires larger stroke length with reduced reciprocating speed. Hence the stroke length along with the reciprocating speed of the table can be adjusted as per the feed material to be classified on the table.

Construction of Wilfley Table:

The constructional feature of a Wilfley table is shown schematically in the figure 8.3. The table is made from wood or similar such material. The table surface is cleated specifically as shown in the figure.

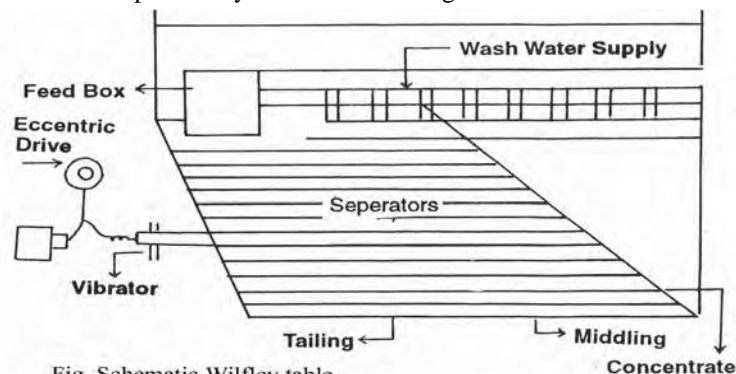
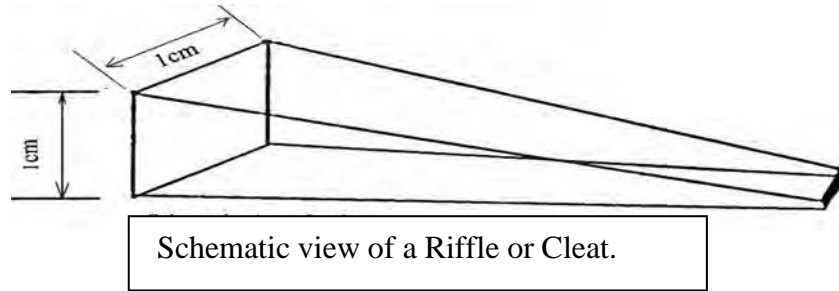

Fig. Schematic Wilfley table.

\Specific discussion on cleats or riffles is required as they require frequent replacement during the working of Wilfley table. The cleats are usually made up wood with a maximum height and width of *one centimeter* each as shown in the figure.



The cleats are tapered from one end to another. They are so placed that they form channels of around 1cm width and deep at the left hand side end and the same tappers down to zero depth at the opposite end. The cleats end along a diagonal line imagined on the Wilfley table which approximately divides the total surface area of the table in the ratio of 2: 1. This means 2/3 of the total surface area of the table is cleated (riffled) and rest 1/3 portion is unriffled. The inclination of the table is from left to right and from the back to front. Such inclination increases the ore handling capacity of the table.

However the inclination should not be large as it hampers the classification efficiency. The normal inclination in both the directions is limited to 0-3 degrees. For majority of ores a slope of 0.75-1.25 degrees is used.

Table Surface:

The surface of the Wilfley is lined with rubber or linoleum to restrict the wear of the wooden table surface and also increases roughness or friction of the table surface. Both riffles and the linoleum lining increase the capacity of the table.

Characteristics of Shaking Table Operation:

Classification:

The Wilfley table handles materials as coarse as 4# and as fine as 200# and under idealized conditions particles segregate into four groups:

- a. Light -large
- b. Large-heavy
- c. Small -light
- d. Small- heavy

Tonnage Handling Capacity of the Table:

The tonnage that can be handled on a Wilfley table depends on the following factors:

- a.* Angle of inclination of the table. Higher the inclination higher is the tonnage handling capacity.
- b.* Size of the feed.
- c.* Whether the operation is roughing or cleaning.
- d.* The difference in specific gravities between the minerals that are to be separated.
- e.* Average specific gravity of the minerals to be treated.

Capacity of Wilfley Table:

It depends on the table size and many other associated factors. However, for a table size of 4ft x 2ft the capacity is around 200 tons /24hrs.

Cost of Operation.

- a. Power 0.5 -----0.8 Kw/hr
- b. Repairing, cost of cleats & deck as and when required.

Important Use of Wilfley Table:

1. It is widely used to concentrate cassiterite or tin ore.
2. It is widely used to concentrate free milled gold ores.
3. It is widely used for beneficiation of nonmetallics like glass and sand.
4. It is widely used for beneficiation chromite and tungsten ores.
4. It is widely used to recover the part of galena and sphalerite in coarse aggregate of lead-zinc ores.
5. It is widely used for cleaning fine coal.
6. It is widely used for beneficiation of some iron ores.
7. It is adopted as a pilot and guide to flotation plants.

CHAPTER 9

FROTH FLOTATION

Introduction:

Flotation is the most widely used method of wet concentration of ores for separating the valuable constituent of the ore from the worthless gangue. The process is primarily a surface phenomena based on the adhesion of some mineral particles to air and simultaneous adhesion of other particles to water in the pulp. It is the most efficient but is the most complex of all ore beneficiation processes. In this process adhesion is made between air bubbles and small mineral particles in such a way that they rise in that pulp. The floating mineralized froth is then skimmed off while the other minerals are retained in the pulp. The above fact is known as *flotation proper*. There is another term called *skin flotation*. In such a case the adhesion is affected between a free water surface and the mineral particles. The particles involved in skin flotation are usually larger than the particles involved in froth flotation. To obtain adherence of the desired mineral particles to the air bubbles, a hydrophobic surface film should be formed on the particle surface. Hydrophilic surface film must be created on the particles which are to be retained in the pulp phase. The most striking outcome of this process is that the specific gravity of the mineral particle has no effect on the flotation. This suggests that minerals irrespective of their specific gravities can be floated.

Another important idea in case of flotation process is the existence of a selective tendency on the part of some mineral particles to adhere to air and others to water. Much research has been done on this most recent and complex means of ore beneficiation which are summarized as follow:

1. Most minerals if suitably protected from contamination adhere to water but not to air.
2. Paraffin & other hydrocarbons adhere to air in preference to water.
3. Some minerals adhere to air naturally and float. This may be due to surface impurities or due to inherent surface property of the minerals.

Such a phenomenon is known as *natural floatability* and usually possessed by coal, graphite, sulphur and other hydrocarbons.

4. But for minerals to be separated by froth flotation, floatability is to be induced on the surface. This is known as *acquired floatability*. For the minerals to acquire floatability suitable chemical reagents are to be added to the pulp for changing their surface properties. The reagents vary in nature depending on the type of ore to be floated. The quantities to be used are extremely small but just sufficient to develop a continuous film around the mineral particles of at least few molecular level thicknesses.

5. Almost all the minerals can be made to adhere to air or water selectively by using suitable chemical reagents. But this selectivity can not be 100% efficient. This means when we are trying to float a particular mineral selectively, other mineral present in that pulp would also float up.

6. Change in the surface condition of the minerals (due to oxidation) will affect the floatability of such minerals considerably.

In general flotation depends on a number of interrelated physico-chemical factors. After treatment with reagents, the air bubbles attach it to the mineral particles and lift them up to the surface of water. The mineral is usually transferred to the froth leaving behind the gangue in the pulp. This is termed as *direct flotation*. However, during *reverse flotation* the gangue is separated into the float fraction while the valuable mineral is retained in the pulp.

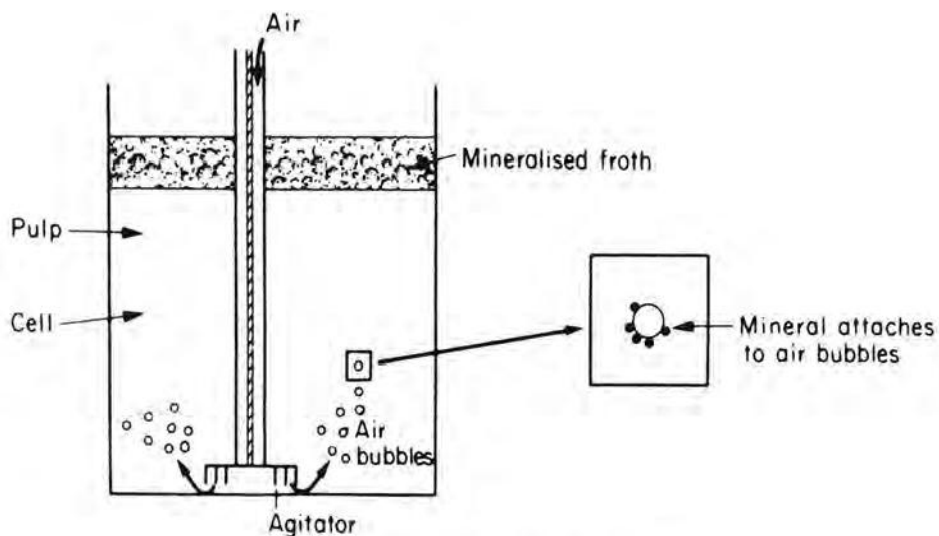

Basic Principles of Flotation.

The process can only be applied to relatively fine particles. The basic idea of flotation is shown schematically in the figure .

Classification of Floatability:

Floatability can be classified as:

Natural floatability and

Acquired floatability.

Natural floatability:

It is generally agreed that hydrocarbons, coal, graphite, sulphur shows large degree of natural floatability. It is to be observed that substances showing natural floatability are non polar substances. So minerals that are polar in nature lack in natural floatability.

Acquired floatability:

By suitably coating the surfaces of one or another a group of minerals with a film that is non-polar, particles of the selected group can be made to act as if they are non polar throughout and made to acquire floatability. Acquired floatability is the result of the actions of a group of reagents called collecting agents or collectors. When the ground ore is mixture of several of minerals of similar nature, to separate them from each other, some minerals should be made more floatable compared to others. To acquire such selectivity specific reagents are to be added to the pulp and are termed as *activators or depressors*. Another group of reagents added to the pulp are known as *modifiers*. *Modifiers* are chemical reagents which suitably modify the surface properties of the minerals so that the surface becomes more amenable to the action of collectors.

Physico-Chemical Principles of Flotation:

Physico-chemical principles of flotation can be explained in terms of surface energy & surface tension, contact angle, polarity and adsorption.

Surface Energy or Surface Tension and Contact Angle: At any interface there exists certain amount of energy called surface energy. The surface forces at the bubble-mineral interface in an aqueous medium are shown schematically in figure .

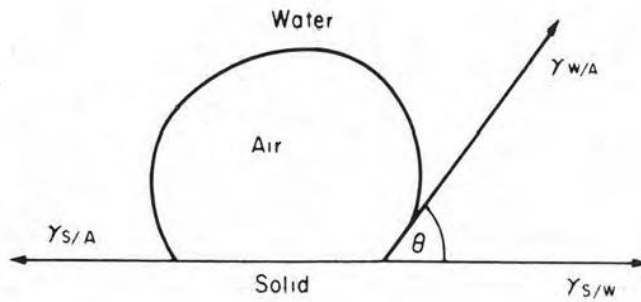

Contact angle between bubble and particle in an aqueous medium.

From the figure it understood that at equilibrium,

$$\gamma_{S-a} = \gamma_{S-w} + \gamma_{w-a} \cos \theta$$

Where, γ_{S-} , γ_{S-w} and γ_{w-a} are the surface energies between the solid-air, solid-water and water-air respectively and

θ is the contact angle between mineral and the bubble as shown in the figure 9.2.

Now work of adhesion:

$$W_{s-a} = \gamma_{w-a}(1 - \cos \theta).$$

It can be seen that greater the contact angle, greater is the work of adhesion between particle and the bubble. The floatability of a mineral therefore increases with the increase in contact angle. Minerals with higher contact angle are said to be aerophilic (air attracting) and minerals with smaller contact angle are said to be aerophobic (air repelling).

Polarity and Adsorption:

All the minerals are classified into polar and non-polar type according to their surface characteristics. Non-polar surfaces do not attach readily to the water phase and are called hydrophobic minerals. Graphite, coal, talc and sulphur are nonpolar minerals and exhibit natural floatability and readily float on water.

Minerals of polar type are hydrophilic and do not float naturally on water. These minerals have to acquire floatability to get floated up. To induce floatability these mineral particles are to be treated with some specific chemical reagents called *collectors*. *Collectors* are organic compounds which get *adsorbed* on the surface of selected mineral particles and produce a continuous heteropolar film in such a fashion that, the nonpolar part of the film is oriented away from the mineral body (as shown in the figure 9.3). Thereafter the mineral particle as a whole becomes non-polar, non-wettable and water repellent. Further it attaches itself preferentially with an air bubble.

2. The air bubble-mineral combination floats up in the fluid as per Archimedes' principle as long as the specific gravity of the combination is lower than the specific gravity of the fluid.

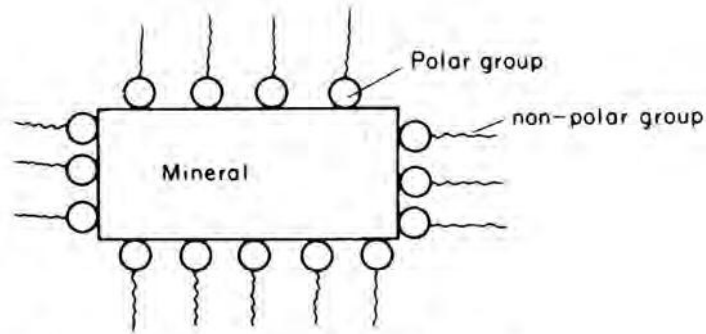

Collector adsorption on mineral surface.

Flotation Reagents:

Froth flotation being a physico-chemical process requires a number of chemical reagents for its successful operation. Broadly the flotation reagents can be classified under following categories:

1. Frothers
2. Collectors &
3. Modifiers.

Frothers:

Frothers are heteropolar surface active organic reagents, capable of being adsorbed on the air-water interface. The adsorption of frothers at the bubble-water interface reduces the surface tension and stabilizes the air bubble. In the froth bubble, the non-polar group is oriented towards the water phase providing the necessary water repellency to the froth as required. A typical froth bubble is shown schematically in the figure .

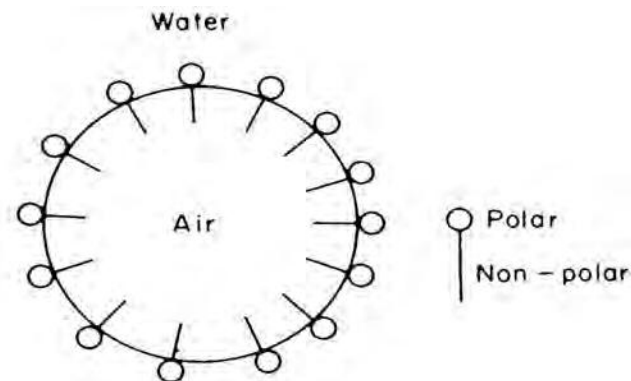

Schematic Froth Bubble.

The frothers practically have no effect on the floatability of the mineral particle in the pulp. Production of persistent froth of desired selectivity and durability is of prime importance in successful flotation. The froth should be strong and stable enough to support the weight of the desired mineral attached to

it and permits its separation from pulp. On the other hand, the froth should break down readily after its removal from the flotation cell. Most widely used frothers are *pine oil*, *isobutyl carbinol* (MIBC), *turpineol*, *aliphatic alcohols* & *cresol* (*cresylic acid*).

Collectors:

The collector is said to be the most important reagent in flotation. Each collector molecule contains a polar and a non-polar group. It gets adsorbed on the mineral surface and forms a continuous heteropolar film all around the particle.

The heteropolar film is so formed that the polar part is attached to the mineral surface and the non-polar group is projected outwardly providing hydrophobicity to the mineral surface. This results in attachment of mineral particles to the air bubbles available in the pulp and ultimately results in flotation. Collectors are broadly classified according to the chemical nature of the nonpolar part available in them as follows:

1. Anionic collectors &
2. Cationic collectors.

Anionic Collectors:

These are the most widely used collectors in froth flotation. If the nonpolar part of the collector, which imparts water repellency to the mineral surface, carries a negative charge on it, it is termed as an anionic collector. The structure of an anionic collector is shown schematically in the figure .

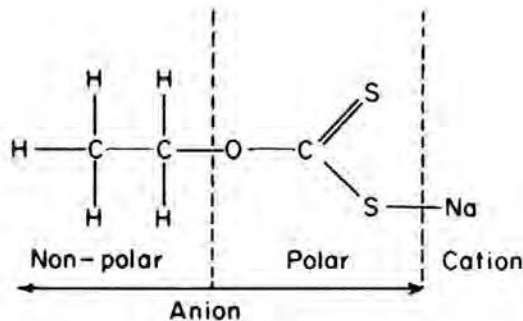

Structure of an Anionic Collector: Sodium Ethyl Xanthate.

Some typical anionic collectors are:

1. Potassium or sodium ethyl xanthate (Xanthogenates),
2. Dithiophosphates (Aerofloats),
3. Thiocarbamates,
4. Fatty acids and
5. Sulphonates.

Xanthates, thiocarbamates & dithiophosphates are primarily used to float sulphide minerals while fatty acids and sulphonates are used for non-sulphide minerals.

Cationic Collectors:

The characteristic property of this group of collectors is that the non-polar water repellent group has a positive charge in place of a negative charge as in the case of anionic collectors. The schematic molecular structure of the cationic collector is shown in the figure .

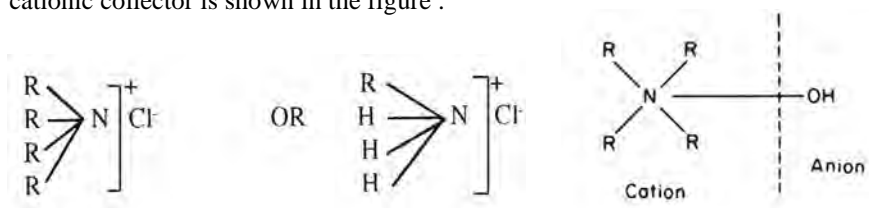

Structure of Cationic Collector.

The most general cationic collector is the fatty amine acetate. Cationic collectors are very sensitive to the *pH* of the pulp. They are most efficient in slightly acidic solutions but inactive in strongly alkaline or acidic media. They are specifically used to float oxides, carbonates and silicate minerals.

3. Modifiers or Regulators:

Sometimes it may be necessary to use a modifier before any collector can be made to function effectively. By means of a modifier, it is possible to accomplish the followings:

- Utilize collectors under optimum conditions
- Prevent or control mutual mineral interaction.
- Prevent or control action of atmospheric air or aquatic ingredients at the mineral surfaces.
- Modify favourably or adversely the ability of some minerals to acquire floatability.

Due to the actions of the diverse chemical reagents tremendous flexibility is achieved with regards to the floatability of the minerals. This is one of the two major reasons behind the success of froth flotation and the other being the applicability of flotation to particles of much finer size on which no other processes can be applied so successfully.

According to their function the *modifying agents* may be classed into one of the following categories:

- pH* regulator.
- Activator.
- Depressant or Depressor.
- Dispersant.

i. pH Regulator:

In the modern froth flotation, alkaline circuits are used almost exclusively for sulphide ores. For any particular ore there is a definite range of *pH* (7 to 13) at which optimum results are obtained. For this reason proper *pH* control of the pulp is of great importance: The reagents commonly used to

control pH & obtain the desired alkalinity are lime, soda ash and sulfuric acid. But use of sulphuric acid has been highly restricted in the present days.

ii. Activator:

It is not only difficult but also impossible to float certain minerals with collectors and frothers alone. Some times xanthates are found ineffective in floating sphalerite and under such condition an activator is used to obtain the desired floatability of sphalerite. The activator ions are adsorbed at the mineral surfaces and enhance adsorption of collectors at the same surface thereafter. The outstanding example of this type of reagent is copper sulphate (CuSO₄) which is used to activate sphalerite. Hydrogen sulphide (H₂S) or sodium sulphide may be used for galena. Copper carbonate or lead nitrate is used to improve the floatability of various non-metallic minerals with fatty acid type collectors.

iii. Depressant or Depressor:

In some cases to induce selective flotation, it is required to prevent or suppress the flotation of a mineral over another. To achieve such a selective flotation, a class of reagents is added to the pulp called *depressant* or *depressor*. Depressing agents are used only to assist separation of a mineral from another. The basic mechanism of this activity is that the depressant gets adsorbed at the mineral surfaces and subsequently inhibit the adsorption of collectors.

Beside lime, which works both as a pH controller & depressant the other widely used depressant is sodium cyanide. Sodium cyanide along with zinc sulphate is a depressant for sphalerite. Dichromate salts are used to depress the flotation of galena.

iv. Dispersant:

Sometimes the gangue may have the nature of flocculating along with the minerals. The extent of flocculation may be such that it interferes with the efficient flotation of the desired minerals. Then it becomes imperative to use a *dispersant* or *deflocculator*. Sodium silicate is used as a *dispersant*. Starch, casein and glue are used to disperse both gangue and carbonaceous materials associated with metallic minerals.

Reagent quantity:

The optimum quantity of various reagents used depends upon the ore being floated and there is no fixed rule to quantify the reagents necessary for a particular activity. However, it is important to remember that the consumption of reagents should be kept as low as possible due to their prohibitive cost. The optimum quantity of reagents to be used for a particular process is determined by trial runs. Average consumption of reagents is listed below:

Reagents	Amount (gms. per ton of ore floated)
Frothers	5 - 250
Collectors	10 - 1000
pH Regulators	10 - 2500

Depressants	10 - 500
Activators	25 - 2000

Variables Affecting Reagent Consumption:

1. Increase in fine particle percentage in the pulp increases the quantity of reagents to be used for proper flotation.
2. Desliming reduces the quantity of reagents consumed considerably.
3. Thick pulp results in some economy regarding the consumption of reagents.

Operational Principles of Flotation:

The success of the flotation operation depends on the following factors:

- a. Particle size,
- b. Surface preparation of the minerals or conditioning,
- c. Pulp density,
- d. Temperature of operation,
- e. Time duration of flotation.

1. Effect of particle size on froth flotation:

Particles of various sizes do not float equally. From experiments it has been found out that flotation is most efficient for particles in the size range of 20-200#. Recovery falls off distinctly in the very fine and coarse range of the feed. The failure to float coarse particles arise from:

1. Incomplete liberation.
2. Too small a contact angle.
3. Violent agitation required to form suspension.

The failures to float extremely fine particles are due to:

a. Poorer chance for mineral - bubble encounter in the fine size range of the mineral.

b. The finer particles have an older surface than coarse particles. As the surfaces of the particles is affected by ions derived from other minerals, oxygen and water during fine grinding, they become unresponsive to reagents and lose their capacity to float. The percentage recovery versus particle size is shown schematically in the figure .

127

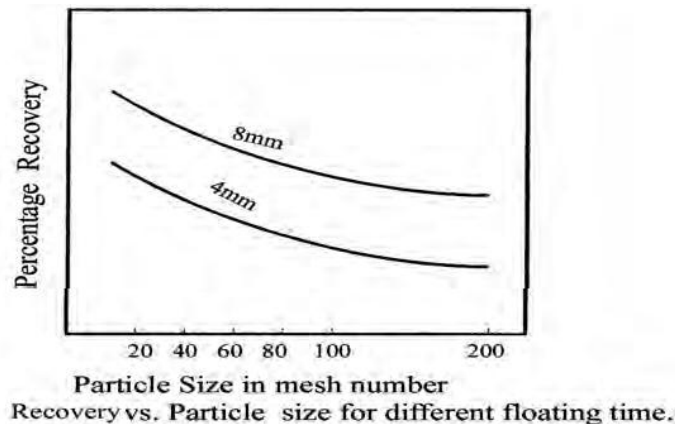

The tentative maximum size ranges of different minerals for efficient flotation are shown below:

Ore / Minerals	Maximum size range (in mesh)
Coal	10-14 #
Sulphides	4-65 #
Gold	100~150 #

Further rate of flotation is also depends on the particle size as shown schematically in the figure.

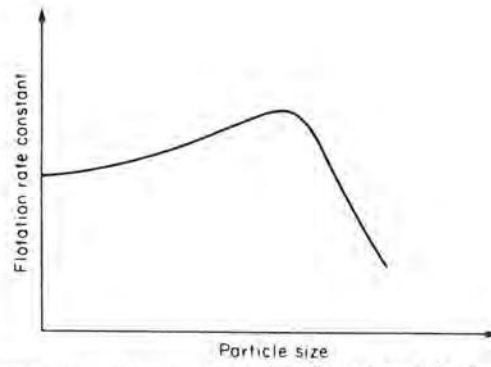

Rate of Flotation vs. Particle Size.

2. Conditioning:

Conditioning is nothing but mixing of ore with water & aeration prior to flotation in a cell. Usually a big tank is used for this purpose. Improper conditioning will have adverse effect on flotation.

3. Pulp density.

For the mineral and gangue particles to get separated during flotation the pulp should be dilute enough to permit particle rearrangement to take place freely. A pulp density of 35% solids by weight shows the best result. Over dilution should be avoided as it results in larger consumption of water and reagents.

4. Temperature:

For obtaining best result during flotation the pulp temperature is to be maintained between 12-20°C.

5. Time Duration of Flotation:

129

The time duration of flotation has a strong bearing on the extent of recovery and grade of the concentrate floated. As time duration increases, the extent of recovery increases with a fall in the grade of the concentrate as shown

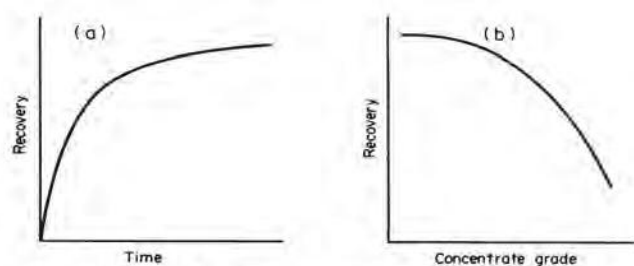

Time, Recovery and Concentrate Grade.

Flotation Machines:

Two important flotation machines are:

1. Pneumatic cell.
2. Mechanically agitated or Sub-aeration cell.

In the pneumatic flotation cells compressed air is directly blown into the pulp while in the sub-aeration cell a rotating impeller serves as a pump which draws in air through the hollow shaft of the impeller and distributes the same into the pulp to produce the froth. In the laboratory, usually a rotating, hollow impeller type sub-aeration cell is used which is shown schematically in the figure

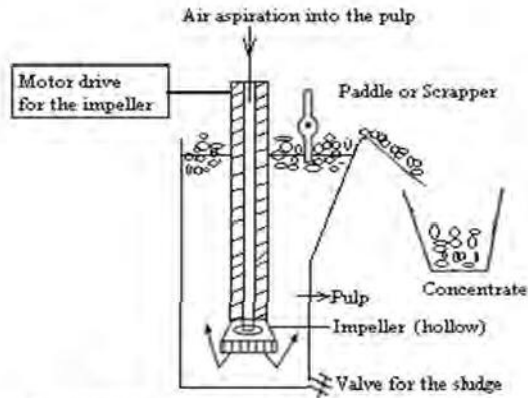

Laboratory model Sub-aeration Cell.

Industrial Model:

In industries hardly a single cell is used for practical floatation work. Rather a series of 10-15 cells connected in series are used-simultaneously. They are connected in such a fashion that one cell receives the defrothed pulp from the preceding cell as its feed. The recovery of such process is usually more than 90%. An industrial pneumatic cell is shown schematically in the figure

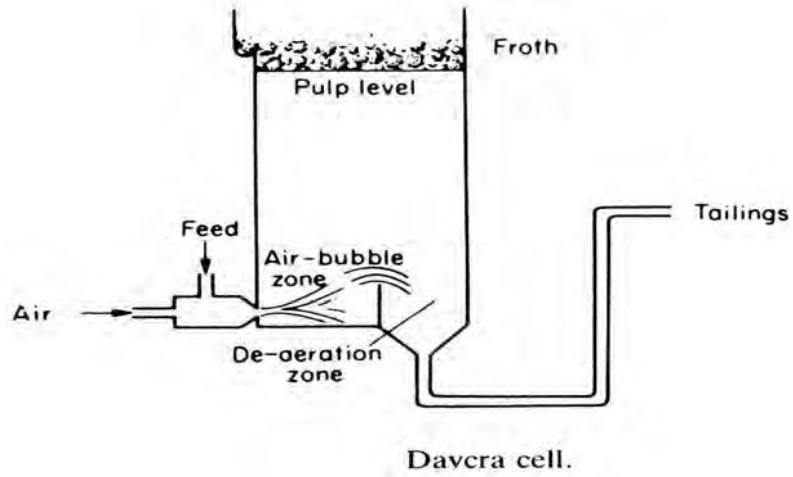

Industrial Flotation Cell.

CHAPTER 10

MAGNETIC SEPARATION

Introduction:

It is a fact that various metallic minerals exhibit magnetic properties. They are attracted by the magnet exhibiting specific attractability. Basing on the degree of attractability minerals can be classified as:

- a. Ferromagnetic
- b. Paramagnetic
- c. Diamagnetic

1. Ferromagnetic Minerals:

Few minerals such as magnetite and pyrrhotite are strongly attracted by magnets and behave as temporary magnets under the influence of magnetic fields. They are known as ferromagnetic minerals.

115

2. Paramagnetic Minerals: _

These are the minerals which are weakly attracted by the magnets. Minerals in this group are illmenite, hematite, garnets etc.

2. Diamagnetic Minerals:

Minerals such as quartz, calcite and many others are practically non magnetic or may even be diamagnetic minerals. These minerals are repelled by a magnetic field along the lines of forces to a point where the magnetic field intensity is much smaller. The magnetic nature of the minerals or ores can be exploited in an industrial sense to separate them into three different groups such as:

1. Highly magnetic.
2. Weakly magnetic.
3. Nonmagnetic or diamagnetic.

This method of separating minerals is broadly termed as magnetic separation. Magnetic separation has found largest application in concentrating ferromagnetic minerals particularly magnetite ores with less than 50% Fe to 70% Fe.

It should be noted that subjecting the minerals to a magnetic field may result in magnetic concentration or separation. *Magnetic concentration* is the separation of valuable mineral from the gangue while *magnetic separation* is the separation of one mineral from another essentially based on the difference in the value of magnetic attractability of the minerals.

Elements in Designing Magnetic Separators:

The following facts are essential and to be considered during the designing of a magnetic separator:

1. Production of a suitably converging magnetic field.
2. Easy regulation of magnetic field intensity.
3. Even feeding of ore particle as a stream or ribbon.

4. Controlling the passage speed of ore particles through the magnetic feed.
5. Avoidance of nonmagnetic materials within magnetic field as occlusion.
6. Suitable means to dispose the products.
7. Provision for production of a middlings.
8. Elimination or reduction of moving parts to a minimum.

Types of Magnetic Separation:

Depending on the magnitude of magnetic flux density, magnetic separation can be classified as follows:

- a. Low intensity magnetic separation.
- b. High intensity magnetic separation.

A further subdivision within the group is possible depending on the medium in which separation is carried out. Depending on the medium of separation it is classified as:

- i. Dry magnetic separation.
- ii. Wet magnetic separation.

Different Types of Magnetic Separators:

a. **Low intensity dry magnetic separator:** This is type of separation is commonly applied to separate highly magnetic particles like magnetite, tramp iron from the non-metallics utilizing a low intensity magnetic flux.

When ore is travel on an endless conveyor belt passing over a magnetic pulley, the non magnetic particles follow a normal trajectory and are thrown clear but the magnetic particles are held firmly to the belt until it is carried out of the field and fall down when the belt just leaves the pulley. This phenomenon is shown schematically in the figure

2. Low Intensity Wet Magnetic Separator:

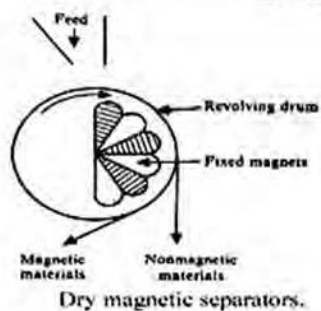
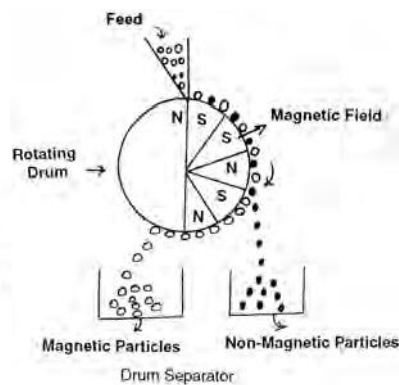
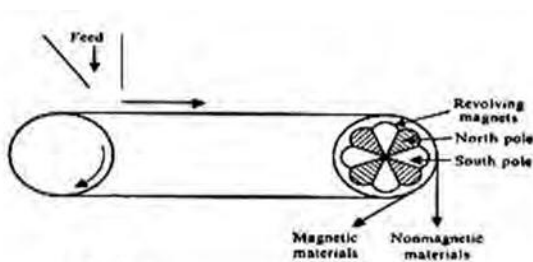

This is widely used today for concentrating of low grade magnetite ore. Wet type has the advantage of treating very fine ores almost in the slurry-form.

Fines are more readily-separated and higher grade product is obtained because water causes a better dispersion of particles and, presents the feed to the separator efficiently.

The Ball-Norton drum separators consist of one or two rotating drums of nonmagnetic metals. In the drum(s), a number of fixed magnets are arranged in such a fashion that consecutive poles are of opposite nature. Much of the magnetic field passes directly from one pole to the other inside the drum, and thereby get wasted.

But enough flux lines come out of the drum to attract and hold the magnetic particles strongly. The particles which are magnetic stick to the surface of the drum and travel along the periphery. They are finally removed-off from the drum surface by the help of a scrapper. The non-magnetic particles just fall off at the edge of the drum during rotation as shown schematically in the figure

In the two drum Ball-Norton machine the second drum revolves at a higher speed and has weaker magnets in side. From the feed slurry, both highly magnetic and weakly magnetic particles get stuck to the surface of the drum in the first compartment while non magnetic particles are removed as tailings at *B*. Both weakly and highly magnetic particles travel along the surface of the first drum and are brought onto a place on the surface of the below which there is no magnet inside the drum. But from this place they are attracted by the magnets facing them in the second drum and shift onto the surface of the second drum placed in the next compartment. As the magnetic field strength is low in the second compartment, only strongly magnetic particles stick to the drum surface and gets collected as concentrate at *D*. The weakly magnetic particles are collected as middlings at *C*. Use of two drums separates the feed ore into three products i.e., concentrate, middling and tailing while single drum separator gives only two products i.e., concentrate and tailing.

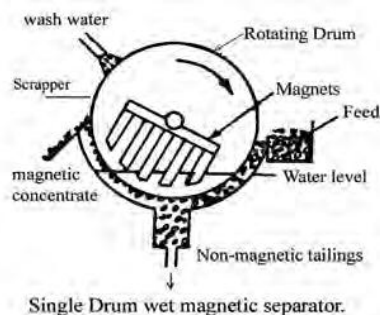

High Intensity Separators:

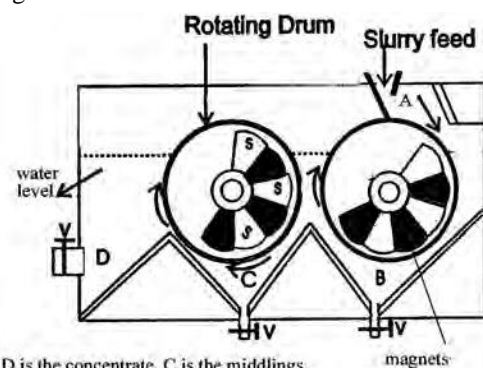

D is the concentrate, C is the middlings
B is the tailings. A is the feed, E are the fixed magnets,
V = the valves.
Fig. Two-Drum Ball-Norton wet magnetic separator.

Very weakly paramagnetic materials can be separated from the ore by employing high intensity magnetic field of 2Tesla or more. The cross-belt pick-up separator is a very popular separator of this kind. Further high intensity induced roll separators are widely used to treat beach sands, wolframite, tin ores and phosphate rock. It is also known as Dings Induced Roll Separator.

Dings Induced Roll Separator:

The induced-roll Dings separator is shown schematically in the figure and mainly consists of:

- i. Horse-shoe magnet *A*.
- ii. An iron keeper *D* facing the magnet *A*.
- iii. Two rolls, one opposite each primary pole.

The separator is shown schematically in the figure103.

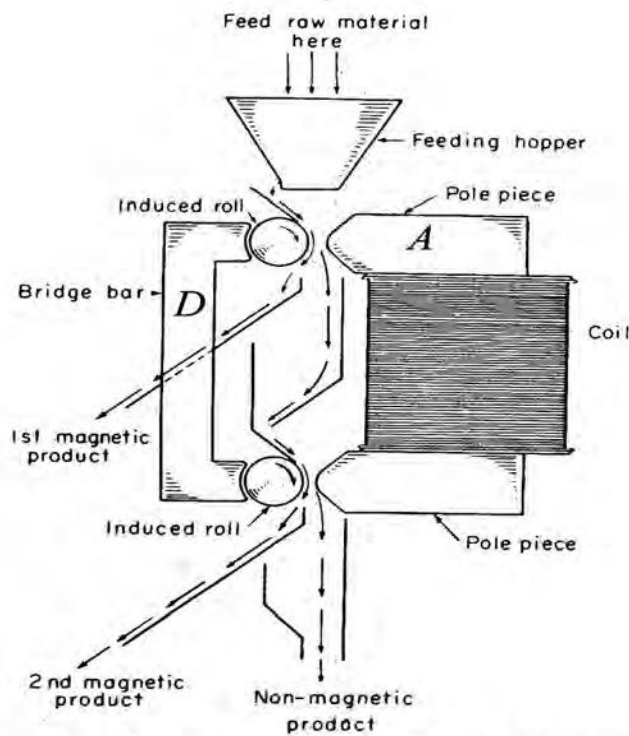

Ding’s High Intensity Induced Roll Separator.

The magnetic circuit is thus completed inside iron excepting for very small clearances between the rolls and the iron keeper and also between the rolls and the poles. The rolls are laminated to behave as a large assembly of secondary poles. The strength of those poles varies as the rolls revolve. It becomes zero twice per revolution. As the ore particles pass over a roll, the magnetic particles are drawn onto the laminated roll and they fall down' only when they are at a position where the magnetic strength of the adjoining secondary pole is zero. This means magnetic particles continue to move along the roll surface to a greater distance compared to non-magnetic particles & fall off much later. So the feed is separated into two fractions as it passes through the rolls. For proper working of Dings separator closely sized feed is required

and it operates best on materials above 75microns. The effectiveness of the separation on fine materials is severely reduced by the effects of air currents, particle-particle adhesion and particle-rotor adhesion. This is applicable and most suitable for separating granular coarse materials of medium to low susceptibility. This is successfully used on materials like mica & MnO₂. After magnetic separation is over the materials retain some amount of residual magnetism. This retained magnetism is to be removed before the concentrate can be treated further. This means the operation next to magnetic separation is to be demagnetization. The greatest advance in the field of magnetic separation is the development of high intensity wet magnetic separation. This has removed the constraint of particle size of the dry separation. The effectiveness of the separation is enhanced as finer grinding is possible leading to maximum liberation of the magnetic fraction.

Applications of Magnetic Separation:

1. For removal of tramp iron in coarse and intermediate crushing circuits as a protection to the crushing machineries.
2. To concentrate magnetite ore.
3. To concentrate ores other than magnetite after converting iron ores to magnetite by magnetic roasting.

4. To remove small quantities of iron or iron minerals from the ceramic rawmaterials

.Other processes of separation:

1. Hand sorting.
2. Electrostatic separation

1. Hand Sorting:

Hand sorting is an ore concentration process which depends on human observation and choice. It is a time consuming process of separating the ore into various grades on the basis of colour, heft, appearance of cleavage and feel. In this process each piece of ore is to be examined for its selection or rejection. So the process is quite tiring and labour intensive and is only suitable for smaller task. Nowadays hand picking is rarely used. The major reasons behind the obsolence of hand sorting or picking are:

1. Increased cost of labour.
2. Low grade feed makes hand sorting extremely difficult.
3. Increased efficiency of other mineral-dressing processes overhand sorting.

Concentration Processes Depending On Electrical Properties of Minerals:

By exploiting the electrical properties of minerals three distinct industrial processes can be developed. They are:

1. Electrostatic separation.
2. Dielectric separation.
3. Electro-osmosis.

Electrostatic Separation:

Electrostatic separation is a method of concentrating or separating minerals from each other on the basis of their differences in electrical conductivities. The basic principle of electrostatic separation is the coulomb's law which implies like charges repel and unlike charges attract. It was first used to separate zinc ore from lead sulphide ore. However, it was abandoned after introduction of froth flotation. But recently it has got a new lease of life for separating non-metallics. Electrical concentration can be broadly classified into:

1. Electrostatic separation.
2. High tension separation.

Theory:

It works on the principle of mutual attraction of unlike charges and mutual repulsion of like charges (Coulomb's law). On the basis of electrostatic charge, a body is said to be positively charged if it is deficient in electrons and is said to be negatively charged if it has excess of electrons. From the electrostatic point, materials can be classified as:

- a. Conductor:* When electrons are highly mobile in them (Metals).
- b. Insulators:* No mobility of electrons in them (plastics, rubber).
- c. Semi-conductor:* Higher mobility of electrons in them as compared to insulators but much less conductivity compared to conductors.

Electron mobility increases in all materials when they are placed inside an electrical field. Almost all the metallic ores and minerals gain electron mobility and develop excess electrical charges when they are placed or brought near a strong electrical field. This is due to electrostatic induction. However, the extent of induction will vary over a large range depending on the material. Depending on the extent of induction ore particles can be classified as:

- a. Better conductors.*
- b. Poor conductors.*

Electrostatic Separator Setup:

In electrostatic separation the feed material is brought near a revolving roll which is either permanently electrified or electrified by means of induction. When the feed material touches the roll or comes near the electrified roll it develops an electrostatic charge on its surface by induction, conduction or by friction from charged drum surface. According to the principle of mutual repulsion of similar electrical charges, better conducting materials are repelled away from the roll surface and fall with a trajectory determined by the size & shape of the particle and the speed of the rotating electrified drum. The poor conducting particles move along the roll surface and have a free fall under the force of gravity. The working of an electrostatic separator is shown schematically in the figure

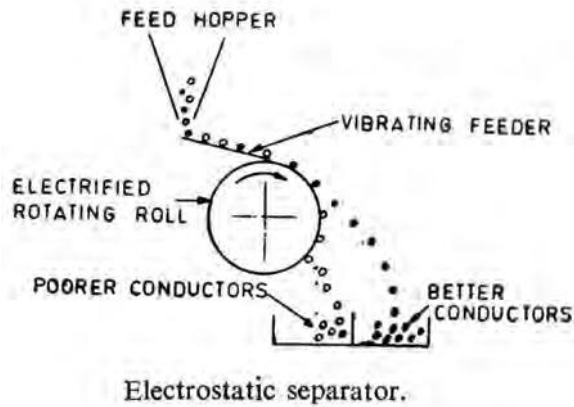

High Tension Electrostatic Separation:

Similar to high tension magnetic separation, there is also a high tension electrostatic separation. During this separation the material grains are charged-up electrically due to ion bombardment on them along with the induction from the electrified drum. Ions are produced in the air gap between the electrically charged wire and the grounded electrified roll due to very high potential difference of few thousand volts maintained between them. The air around the wire becomes ionized and is attracted toward the grounded roll to discharge its ions.

Usually a potential difference of 30kV and above is applied to the wire electrode to make a corona discharge. The wire electrode is also known as corona electrode. If the voltage difference is sufficiently high the ionized corona is visible as a luminous discharge. On entering into the electric field the conducting mineral particles are bombarded with gaseous ions and get charged negatively and thus get deflected away from the ground roll. The non conducting particles are not deflected and have a free fall as it happens in case of usual electrostatic separator. The working principle of high tension separator is shown schematically in the figure

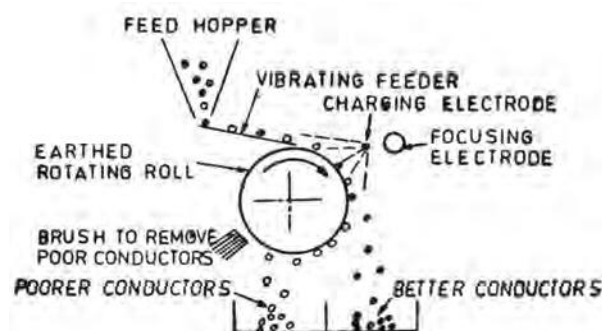

The dry mineral grains are fed as a layer of one particle deep onto the

electrified roll with the help of a vibrating and get separated as per the principle discussed earlier. High tension electrostatic separator is also known as Huff's separator.

Requirements for the Proper Working of an Electrostatic Separator:

1. For electrostatic separation, feed materials must be dried prior to separation.
2. For effective separation dry minerals grains are to be fed as a layer of one particle deep at the top of the rotating electrified roll. This is achieved by using a vibrating feeder.
3. For effective high tension separation, feed must be closely sized in the range of 1.0 - 0.1 mm free from fines. Quite often the feed material the feed material is to be heated above room temperature for effective separation.

Use

1. It is employed to separate conducting ores and minerals from non-conducting materials in ceramic industries.
2. This is applied for beneficiating rutile beach sands from non-conducting silica sand in rare earth plants.

